

mogogo



2023 / 2024

V·Shield

SYSTEM

DISTRIBUTED BY:





DOUBLE WIDE SHIELD WITH OPENING
MG CDVO03 CSAS

INDEX

- 4 About Mogogo
- 6 About The V-Shield System
- 7 Materials
- 8 How It Works
- 12 Single Shield
- 14 Multiple Shield Configurations
- 18 Unique features
- 19 V-Shield components



A MODULAR F&B
FURNITURE BRAND

BORN FROM A PASSION FOR **STYLE & GASTRONOMY**



Mogogo is led by designers and chefs that are aiming to introduce innovative, luxurious, and highly functional equipment to foodservice professionals.



LINENLESS



MODULAR



MOBILE



SUSTAINABLE



ADD ONS



ABOUT THE V-SHIELD COLLECTION

Mogogo's "Free Standing" V-Shield System was designed for safety, without sacrificing quality and aesthetics.

It can be utilized on most surfaces of any length with adaptive features to turn corners and shield the edges.

The system consists of two different size guards with the option of a full or partially full-length acrylic panel, depending on the specific application.

The V-Shield legs are equipped with magnets, alignment notches and anti-slip pads for additional stability and a clean gap-free appearance.



MATERIALS

The V-Shield System is made of hygienic and durable materials to ensure it holds up under challenging conditions.

(1) 1/4" (6mm) thick Acrylic Panel

(2) 1/4" (6mm) thick Stainless Steel Base

(3) Tailor-made powder coated aluminum profile uprights.



Watch our video to learn more about
the V-Shield collection

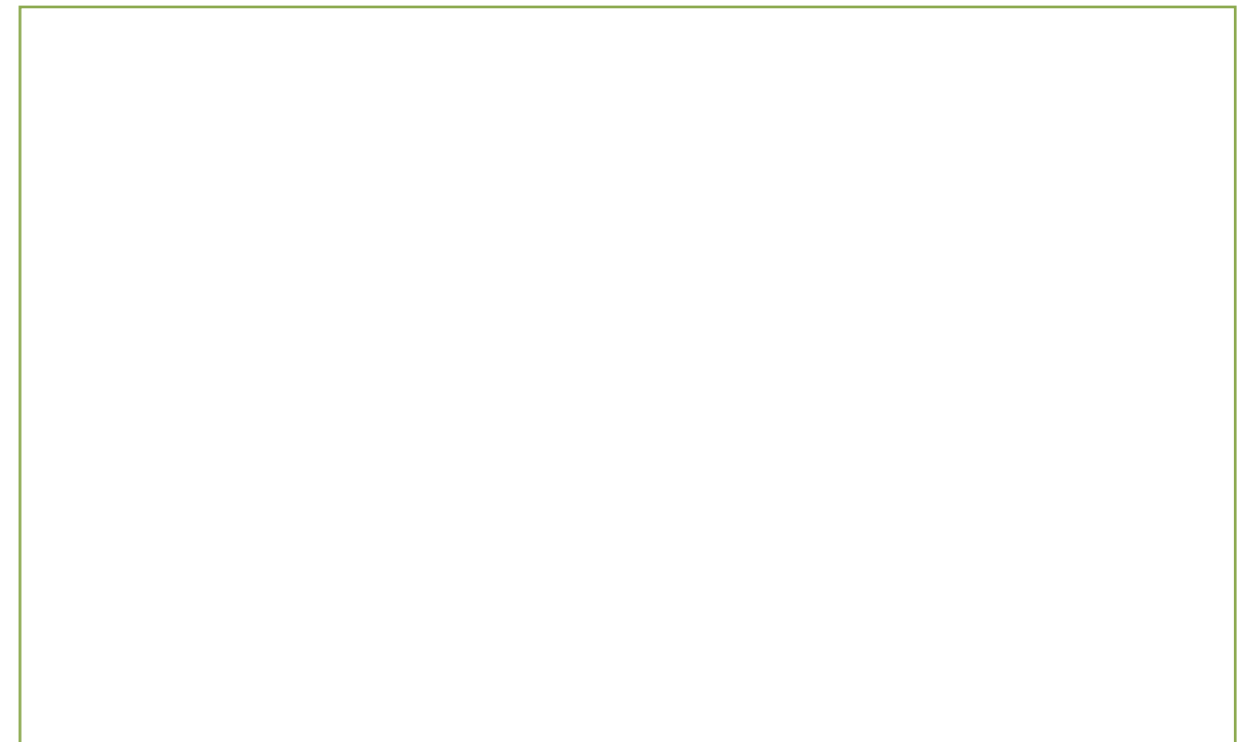

See more videos by Mogogo here

HOW IT WORKS

V-Shields are delivered flat packed and can be assembled in minutes with an Allen Key. With the wide and narrow shields, combined with the corner and end panels, creating a safe and functional configuration for your application has never been easier.

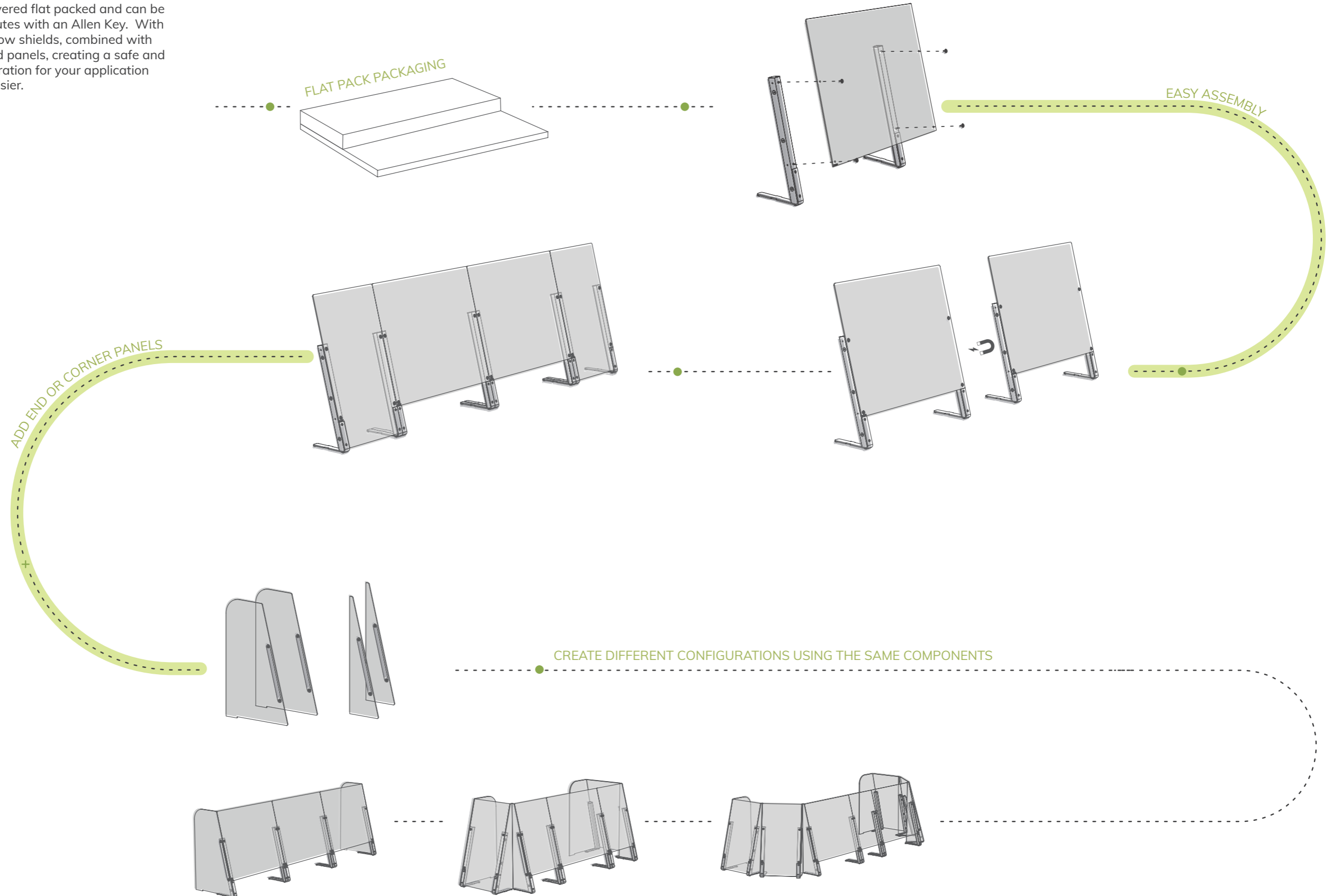



ANTI-SLIP PADS

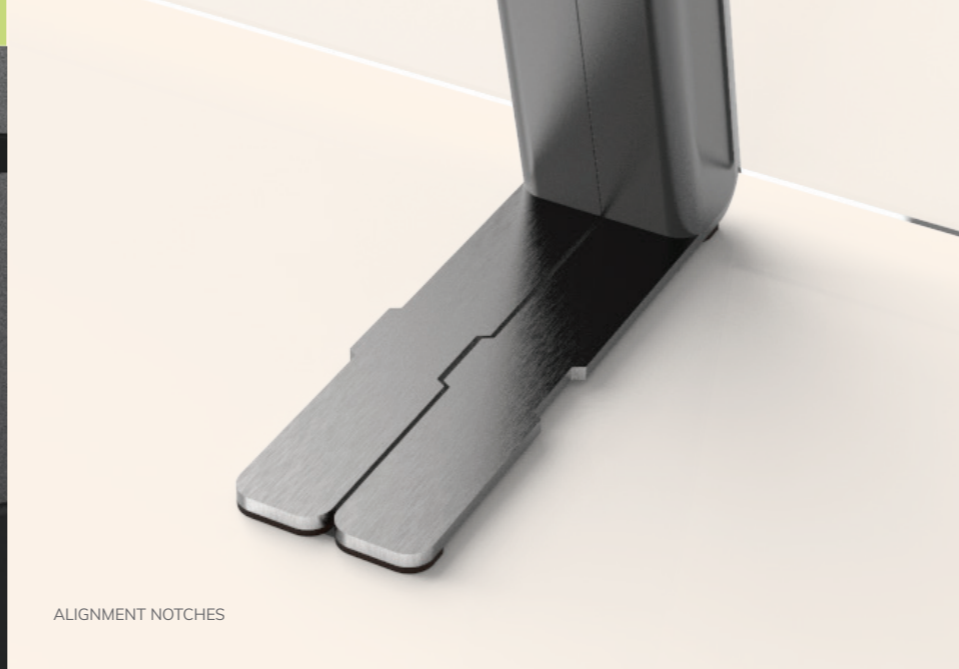

ALIGNMENT NOTCHES

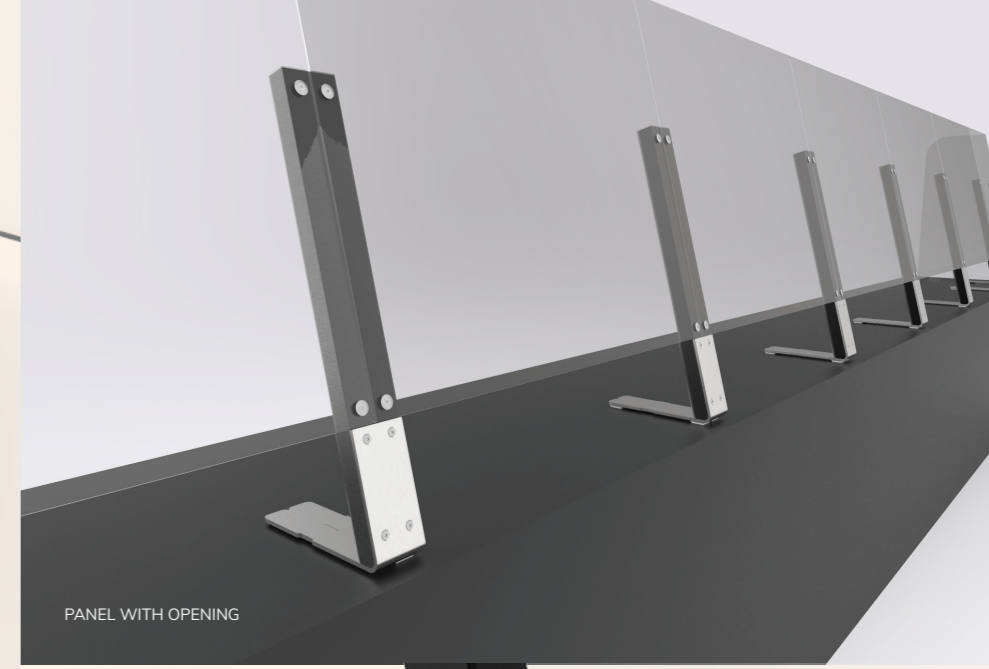

PANEL WITH OPENING

DETAILS

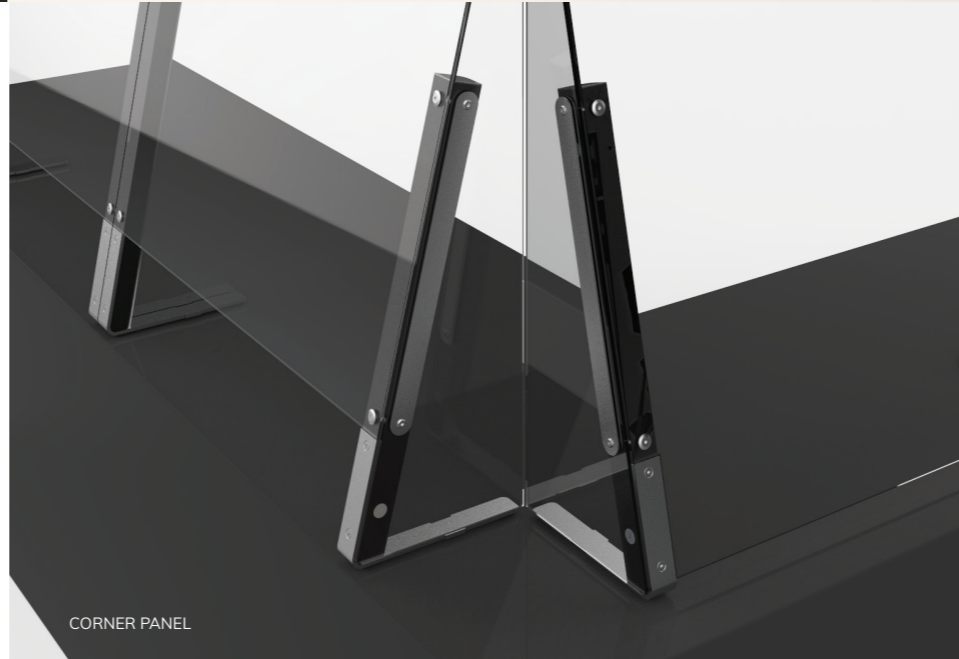

CORNER PANEL



FULL PANEL



GUIDING PINS

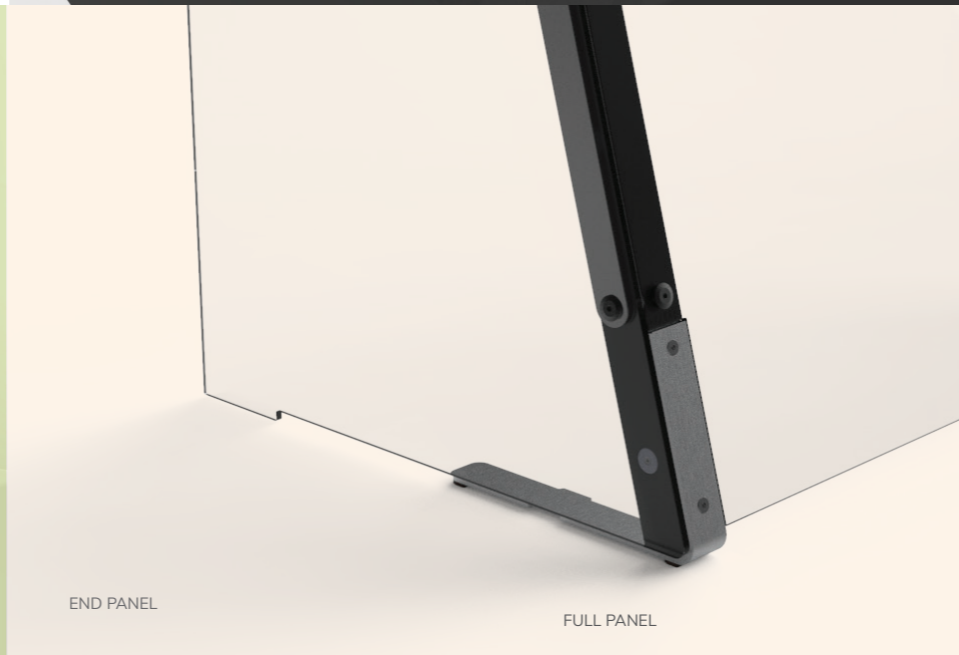

END PANEL

FULL PANEL



MAGNETS

SINGLE WIDE UNITS



WIDE SHIELD
W89cm H90cm | W35" H35½"
MGCDVO01CSAC

WIDE SHIELD WITH OPENING
W89cm H90cm | W35" H35½"
GAP 6" 15cm
MGCDVO01CSAS

SINGLE NARROW UNITS



NARROW SHIELD
W50cm H90cm | W20" H35½"
MGCDVO02CSAC

NARROW SHIELD WITH OPENING
W50cm H90cm | W20" H35½"
MGCDVO02CSAS



WIDE SHIELD
MGCDVO01CSAS

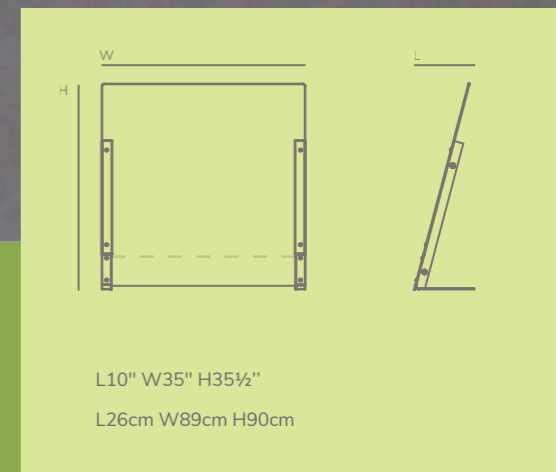

UNIQUE FEATURES

CORNER PANELS

The V-shield corner panels are designed to create configurations that require tight corners or a gentle radius, while maintaining a tight seal.

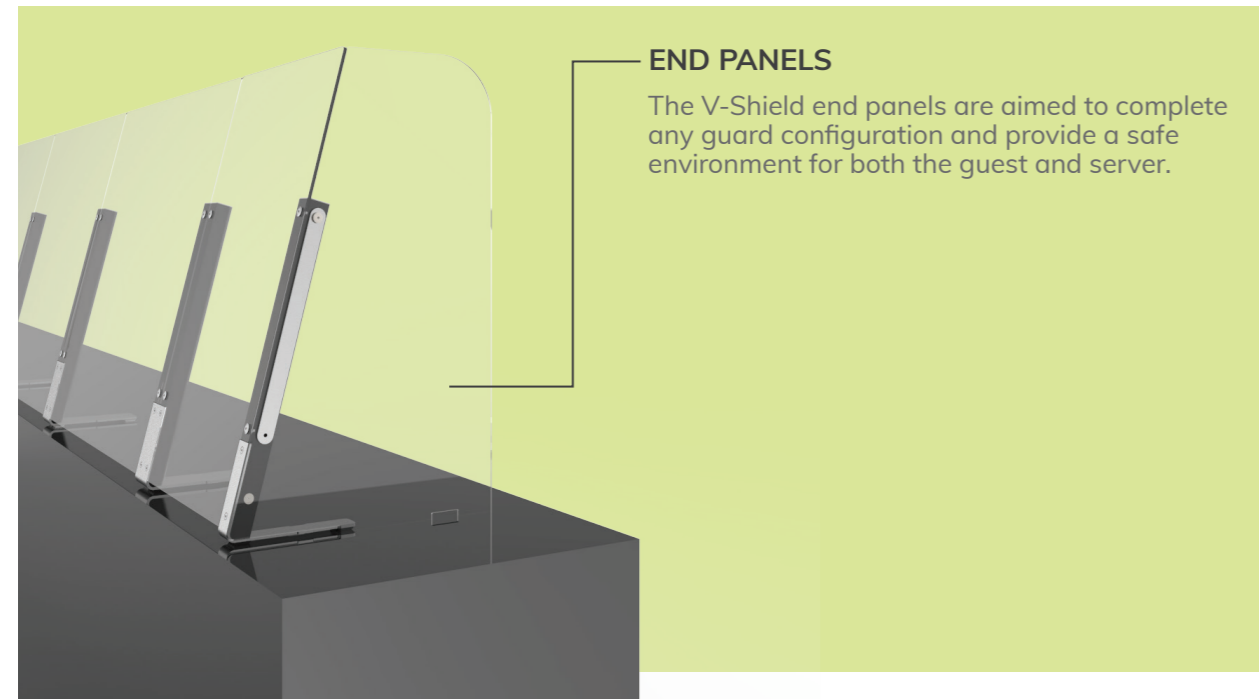
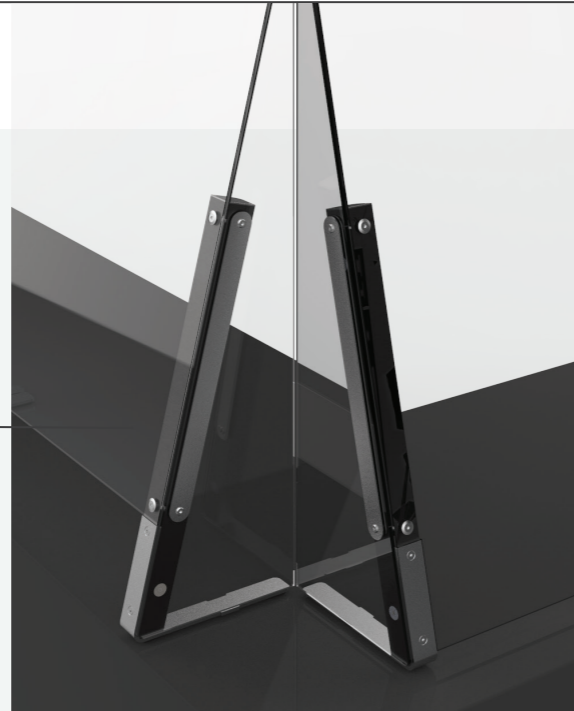

END PANELS

The V-Shield end panels are aimed to complete any guard configuration and provide a safe environment for both the guest and server.

MULTIPLE SHIELD CONFIGURATIONS



DOUBLE WIDE SHIELD WITH OPENING
MGCDV003CSAS

DOUBLE CONFIGURATIONS

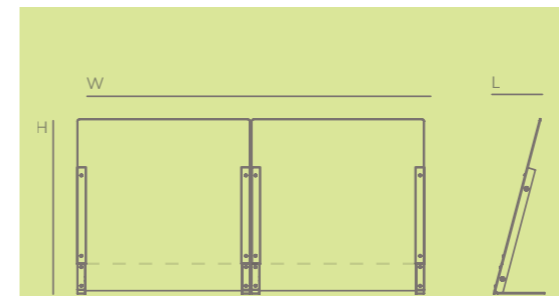

L10" W70" H29½" / 35 ½"
L26cm W178cm H75cm / 90cm

TRIPLE CONFIGURATIONS

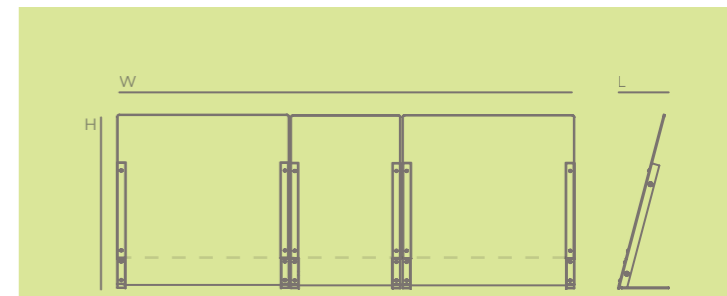

L10" W90" H29½" / 35 ½"
L26cm W228cm H75cm / 90cm

V-SHIELD COMPONENTS

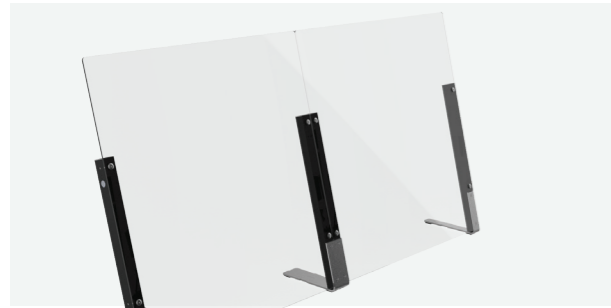

DOUBLE WIDE SHIELD
W178cm H90cm | W70" H35½"
MGCDVO03CSAC
for 6' | 180cm TABLE



EXTRA WIDE SHIELD
W228cm H90cm | W90" H35½"
MGCDVO05CSAC
for 8' | 244cm TABLE



DOUBLE WIDE SHIELD WITH OPENING
W178cm H90cm | W70" H35½"
MGCDVO03CSAS
for 6' | 180cm TABLE



EXTRA WIDE SHIELD WITH OPENING
W228cm H90cm | W90" H35½"
MGCDVO05CSAS
for 8' | 244cm TABLE

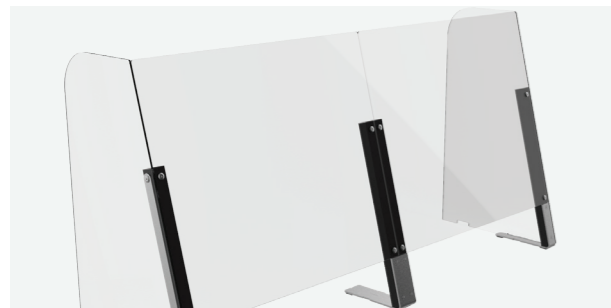

DOUBLE WIDE SHIELD WITH OPENING AND END PANELS
W178cm H90cm | W70" H35½"
MGCDVO04CSAS
for 6' | 180cm TABLE



EXTRA WIDE SHIELD WITH OPENING AND END PANELS
W228cm H90cm | W90" H35½"
MGCDVO06CSAS
for 8' | 244cm TABLE

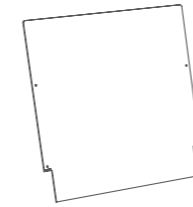

WIDE ACRYLIC PANEL
W89cm H91cm | W35" H36"
MGSVSDPG0101

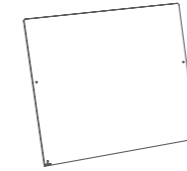

WIDE ACRYLIC PANEL WITH OPENING
W89cm H75cm | W35" H29½"
MGSVSDPG0201



NARROW ACRYLIC PANEL
W50cm H91cm | W20" H36"
MGSVSDPG0301

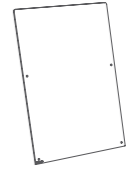

NARROW ACRYLIC PANEL WITH OPENING
W50cm H75cm | W20" H29½"
MGSVSDPG0401



SET OF LEGS
MGSVSDSM0101

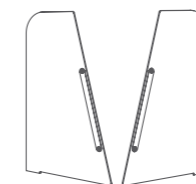

SET OF ACRYLIC END PANELS
MGSVSDSM0301

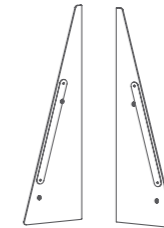

SET OF ACRYLIC CORNER PANELS
MGSVSDSM0201





www.steelite.com

America
154 Keystone Drive
New Castle, Pennsylvania 16105
toll free: 800-367-3493
Telephone: 724-856-4900
Fax: 724-856-7925
Email: usa@steelite.com

Canada
Unit 2, 26 Riviera Drive
Markham, Ontario L3R 5M1
Toll Free: 800-465-4284
Telephone: 905-752-1074
Fax: 905-752-1120
Email: canada@steelite.com

United Kingdom &
Republic of Ireland Steelite
International Ltd Orme
Street
Stoke-on-Trent
ST6 3RB
England
Telephone: +44 (0)1782 821 000
Fax: +44 (0)1782 819 926
Email: headoffice@steelite.com

Showrooms available by appointment:
Atlanta • Chicago • Cincinnati • Las Vegas
London, UK • Los Angeles • New York
Stoke-on-Trent • Toronto, ON • Washington, D.C.
Youngstown, OH

Magogo
catalogs



More configurations can be found on our website.
Dimensions are approximated due to conversions.
The entire content is subject to misprints and errors.
Art-No. VSC-USA2022-23



www.mogogo-buffet.com
info@mogogo-buffet.com



www.steelite.com



CHECK OUT OUR OTHER COLLECTIONS



Modular
SYSTEM



Roll'n
SERVICE CARTS



Canvas
SHELVING SYSTEM



PoLo
TABLES



GrabIt
SIDE TABLES



Clix
TABLES