



Modular  
SYSTEM



Roll'n  
SERVICE CARTS



CIX  
TABLES



mogogo  
BUFFET SOLUTIONS



PoLo  
TABLES



V-Shield  
SYSTEM



Canvas  
SERVING SYSTEM



DISTRIBUTED BY: The logo for steelite INTERNATIONAL, featuring a grid of black dots of varying sizes to the left of the text "steelite INTERNATIONAL" in a bold, sans-serif font.

2022/2023  
COLLECTIONS

mogogo  
BUFFET SOLUTIONS



Modular  
SYSTEM

2022/2023

DISTRIBUTED BY:  steelite  
INTERNATIONAL



CLASSIC SMALL UNIT MG CMLX03 GSXF

## INDEX

 New Products

 Chef

 Waiter

 Bartender

 See Page



A PROFESSIONAL  
FOOD & BEVERAGE  
FURNITURE COMPANY

BORN FROM AN INTERDISCIPLINARY  
PASSION FOR **Design x Food**



Mogogo is led by designers and chefs that are driven by the desire to introduce new, beautiful, and functional products to the market, with an environmentally friendly philosophy in mind.

WE PUSH  
THE CREATIVE ENVELOPE  
OF FUNCTION AND INNOVATION.



LINENLESS



MODULAR



MOBILE



SUSTAINABLE



ADD ONS







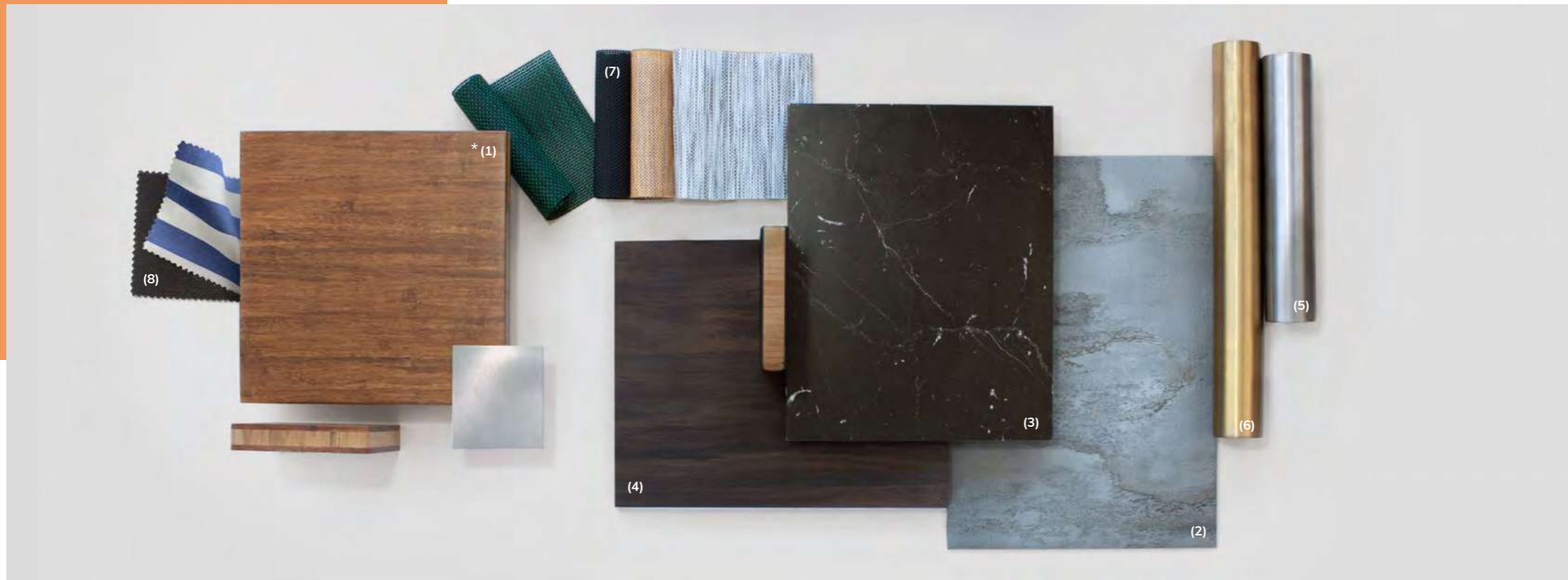

## ABOUT MODULAR COLLECTION

Mogogo's flagship collection, the Modular System, allows you to use the same components in various ways to create different configurations of products. Our Modular System Line is composed of our Classic and Creative Ranges, and a large variety of complementary accessories.

Our Classic Range consists of buffet tables and shelves that fit each other seamlessly, functioning as building blocks to the Mogogo System. The classic range is characterized by sleek linear design, adaptable to both traditional and more modern, edgier looks.

Our Creative Range comes with a curved design concept. Our Creative system is patented and offers unique features based on our vast experience in large food service operations.

Our stations are carefully designed maintaining a delicate balance between high functionality, durability, and mobility; all in perfect symbiosis with high design standards, providing an ideal solution for the Food and Beverage industry.

 Classic Range |  Creative Range

## MATERIALS

Joining our Bamboo (1)\* collection is our innovative BHP material. BHP is a newly composed material that arrived after two years of intense R&D. It merges layers of High-Pressure Laminate with a Vertical Bamboo core (Mogogo's expertise) creating a lighter yet durable panel that offers new textures and colors. This new material combines the advantages of both bamboo and HPL, perfect for the ever-changing needs of the hospitality industry. BHP is available in a variety of finishes that resemble natural materials such as Grey Slate, Nero Marquina Marble, and Bengali Mango Wood (2-4), making it easy to match with any event and decor. The innovative bamboo core of the BHP goes in line with Mogogo's sustainability motto while the HPL's outer coating is durable for different environments, hygienic and easy to clean.

Modular segments come in 2 finishes: brushed stainless steel (5) and brushed brass (6).

Easily cover up parts of your buffet stations with our original quick covers (7). Both durable and easy to clean, they come in 4 different color options allowing you to easily match any of your event color schemes.

For that extra outdoor feel, add a canopy (8) to your buffet station, made from a sturdy Cordura fabric known for its resistance to abrasions, tears, and scuffs.

\* High-Density Bamboo finish only available in North America

## HOW IT WORKS

The Mogogo Modular System is composed of individual parts, which can be assembled to create endless configurations. These individual components sit at the core of the Mogogo Modular System. In fact, they are utilized as the base for creating Action Stations, Buffet Stations, Bar Stations, and more when combined with add-ons, in order to offer the perfect customized touch for all of your buffet solution needs.

All Buffet Stations have essential elements: tabletops, mid-part segments, and leg segments (permanent or mobile casters). From there, you can start choosing your add-ons: different shelves, sign posts, quick covers, arches, etc., for the ultimate customization.

What is unique about Mogogo's configurations is the freedom of building any stations you want from the exact same parts. Start with a Basic Station and add shelves: it makes for the ideal Breakfast Station. Add a different tabletop and covers: it becomes an elegant Bar Station.

When the sum of parts is bigger than the whole, we deliver on unique and endless possibilities.

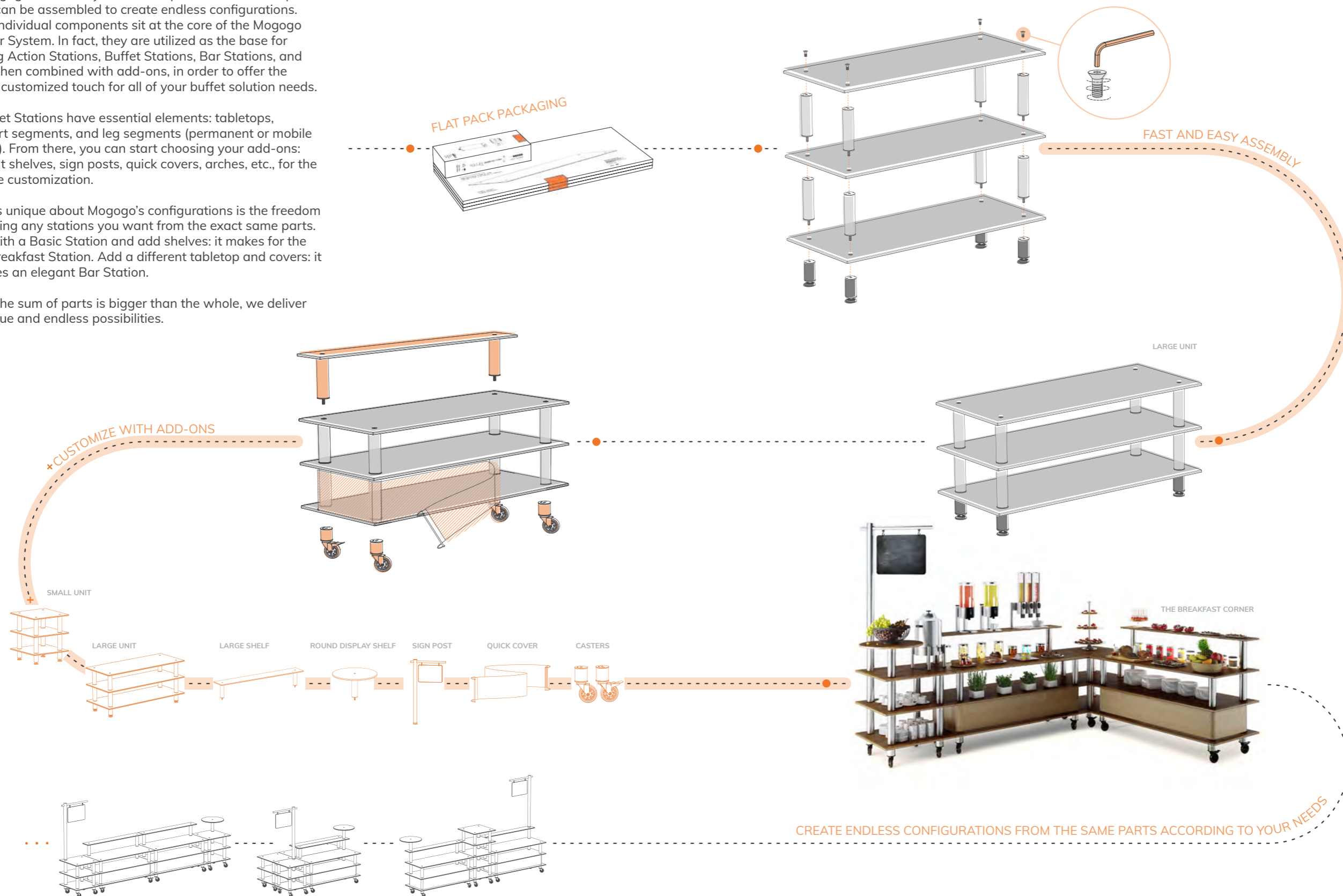





MG CMLB10 GBBW (shown with optional quick covers)



MG CMLA06 BSXW (shown with optional quick covers)

Mogogo's unique Modular system allows its stations to be extremely versatile and functional. By adding different elements you can custom fit any event or venue. These add-ons are easy to incorporate and provide edgy looks that will stand out.



MG CMLD12 MSXW (shown with optional quick covers)

# ADD-ON COMBINATIONS



MG CMLB11 MBXW (shown with optional quick covers)



MG CMLB12 BBXF



\*  
The different finishes combined with brass or stainless steel create infinite options for styling.



MG CMLC05 MSXW (shown with optional quick covers)







**OPEN C SERVING STATION** MG CMSA01 WBXF  
(shown with optional Golden-Brown quick covers)

## ACTION STATIONS

Guests' fascination with chefs, food preparation, and presentation around the Action Station continues to grow and evolve in events today - it's a great way to add some spice and surprise to your culinary landscape.

Mogogo's Action Stations are designed to enhance the interactive experience of your guests through elegant design, while providing chefs and F&B professionals all the functional elements they are looking for. From an omelet station to a make-it-your-own dish station, Mogogo Action Stations are extremely modular; our ever-expanding line of add-ons and a wide range of tabletops deliver functionality and authenticity.

Cooking in front of the guest entices all their senses - and we believe beautifully crafted furniture is part of the experience.



## MATERIAL GUIDE

Customize your Modular Stations by choosing from the different colors and finishes available.

Simply choose your preferred design combination by inserting the corresponding letter to its designated space as demonstrated below.

Item code	Design combination			
MG C#####	TOP	SEGMENT	TEXTILE	BASE
	<b>M</b>	<b>S</b>	<b>W</b>	<b>F</b>
	Nero Marquina Marble BHP	Brushed Stainless Steel	Blue and White stripes	Adjustable legs
	<b>G</b>	<b>B</b>	<b>B</b>	<b>W</b>
	Grey Slate BHP	Brushed Brass	Black	Casters
	<b>W</b>			
	Bengali Mango Wood BHP			
	<b>*B</b>			
	* High-Density Bamboo finish only available in North America			
	* High Density Bamboo			

EXAMPLE:

MG CMLB10 **GBWF** =



### OPEN C SERVING STATION

Neither round nor square, this station creates a minimalist and functional approach, designed to serve large crowds with minimal effort.

MG CMSA01 **WSXF**



### CLASSIC CANOPY COOLING STATION

Chilled tabletop for a contemporary Food Market feel with hygienic stainless steel top and insulated ice bin with drain.

(shown with optional Silver-Grey quick covers)

MG CMLA01 **MSWF**



### CREATIVE DIY STATION

Combining circular and linear units, this design layout makes for the ideal make-your-own dish station that enhances the customer's experience.

(shown with optional Charcoal-Black quick covers)

MG CMSA02 **GSXF**



### PRO SALSA BAR STATION

This station provides chefs with a perfect combination of a stainless steel workspace with extra storage and display areas to impress their diners.

(shown with optional Charcoal-Black quick covers)

MG CMLA02 **MSXW**





**BAZAAR ACTION STATION MG CMLA03 GSWW**  
(shown with optional Silver-Grey quick covers)





**SMALL S BUFFET** MG CMSB03 GSXW  
 (shown with optional Large Oval high display shelf and Small Oval low display shelf)



## BUFFET STATIONS

As a fundamental functional element to any F&B operation, we believe Buffet Stations no longer need to be hidden under heavy linens nor lifted by the staff.

Mogogo takes an innovative and sustainable approach to Buffet Stations by introducing new design and functionality for linenless F&B Furniture, revealing beautiful clean lines. The presentation of a station is just as important as the quality of food being served and Mogogo offers ideal solutions for Chefs to display their most exquisite dishes. From Classic to Creative, Mogogo Buffet Stations offer a wide range of display and self-service options. Above, add shelves to elevate the dining experience of your guests; below, add our Quick Covers to conceal extra storage space.

Maximize every corner of your catering space by mixing and matching between our Classic Range and Creative Range to reinvent the experience of self-service in events.



## MATERIAL GUIDE

Customize your Modular Stations by choosing from the different colors and finishes available.

Simply choose your preferred design combination by inserting the corresponding letter to its designated space as demonstrated below.

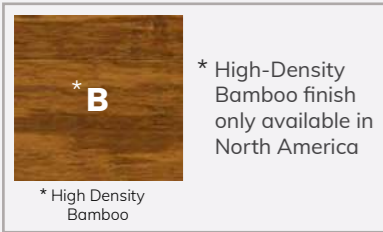
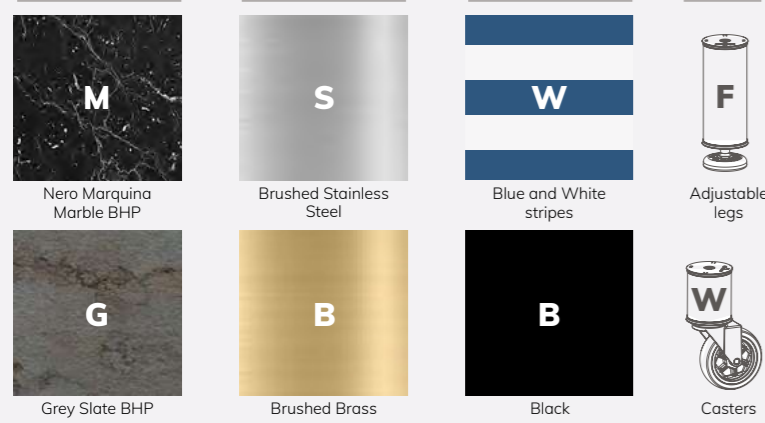
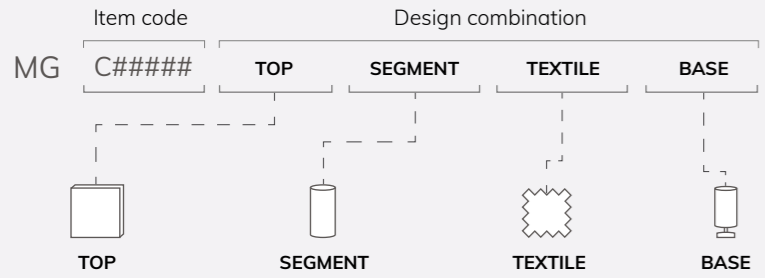

EXAMPLE:  
MG CMLB10 **GBWF** =



### COOLING CORNER STATION

Make the best use of space with this classic corner buffet station that gives all the advantages of a Mogogo station without taking up extra event space.  
(shown with optional Golden-Brown quick covers)

MG CMLB01 **BSXW**



### SELF SERVICE CHILLED SALAD STATION

Make a statement in any event with a chilled food station equipped with insulated ice bins and protective self-service high breath guards.  
(shown with optional Silver-Grey quick covers)

MG CMLB03 **GSXW**



### CLASSIC CURVED BUFFET STATION

This unique double-sided streamlined display station is not only beautiful but functional as well, designed to serve large crowds.  
(shown with optional Silver-Grey quick covers)

MG CMLB02 **MBXW**



### BREAD AND PASTRY STATION

Create a focal point in any event with this extra high buffet station, giving more storage and presentation area than ever before.  
(shown with optional Golden-Brown quick covers)

MG CMLB04 **WSXF**

## MATERIAL GUIDE

Customize your Modular Stations by choosing from the different colors and finishes available.

Simply choose your preferred design combination by inserting the corresponding letter to its designated space as demonstrated below.

Item code	Design combination			
MG C#####	TOP	SEGMENT	TEXTILE	BASE
	<b>TOP</b>	<b>SEGMENT</b>	<b>TEXTILE</b>	<b>BASE</b>
<b>M</b>	<b>S</b>	<b>W</b>	<b>F</b>	
Nero Marquina Marble BHP	Brushed Stainless Steel	Blue and White stripes	Adjustable legs	
<b>G</b>	<b>B</b>	<b>B</b>	<b>W</b>	
Grey Slate BHP	Brushed Brass	Black	Casters	
<b>W</b>				
Bengali Mango Wood BHP				
<b>* B</b>				
* High-Density Bamboo finish only available in North America				
* High Density Bamboo				

EXAMPLE:

MG CMLB10 **GBWF** =



### MARKET SQUARE

The classic look and feel of a traditional market with a modern flair gives this configuration all the functionality and practicality a large buffet station needs.

MG CMLB07 **WBXF**



### ROUND MARKET

Acting not only as the event's focal point, this 360-degree buffet experience will also prevent chaotic queues.

MG CMSB01 **MSXF**



### MULTI HEIGHT DISPLAY STATION

Create unforgettable events with this eye-catching display station, scattered with interchangeable display shelves in different heights. (shown with optional Charcoal-Black quick covers)

MG CMLB08 **MBXF**



### MEDIUM S BUFFET

Avoid hectic buffet lines with Mogogo's Creative S station which gives a smooth crowd flow in any event.

MG CMSB02 **GSXF**





**ALL STAINLESS PRO BAR MG CMLC06 MSXW**  
 (shown with optional Charcoal-Black quick covers)



## BAR STATIONS

Redefine guests' expectations in any F&B operation by elevating their drink and beverage standards. From classic wine bars to mixology & curated cocktails - Bar Stations across your venue are an opportunity to make a statement.

Mogogo's Bar Station Collection features highly adaptable stations that can be used in a wide range of event types and sizes. Easily transportable from one venue to another thanks to their heavy-duty casters, Mogogo Bar Stations combine sleek design and high functionality.

Customize your station with our versatile Add-Ons and quickly conceal bottom shelves for additional storage with our Quick-Covers.

Everything in foodservice, for guests or chefs, is about the experience. Mogogo Bar Stations deliver on the promise of innovative functional design.

## MATERIAL GUIDE

Customize your Modular Stations by choosing from the different colors and finishes available.

Simply choose your preferred design combination by inserting the corresponding letter to its designated space as demonstrated below.

Item code: MG C#####

Design combination: TOP SEGMENT TEXTILE BASE

TOP	SEGMENT	TEXTILE	BASE

\* High-Density Bamboo finish only available in North America

EXAMPLE:

MG CMLB10 **GBWF** =



### PRO BAR & BACK BAR STATIONS

The Pro Bar is equipped with a stainless steel working surface, ice bin and speed-rail. Combined with a Mogogo Pro Back Bar, it's a bartender's dream. (shown with optional Silver-Grey quick covers)

PRO BAR ..... MG CMLC05 WSXW

PRO BACK BAR ..... MG CMLC01 WSXW



### ALL STAINLESS PRO BAR & BACK BAR STATIONS

Mogogo's classic Pro and Back Bars get an updated look with all stainless tops for an extra professional look and feel.

(shown with optional Charcoal-Black quick covers)

ALL STAINLESS PRO BAR ..... MG CMLC06 MSXW

ALL STAINLESS PRO BACK BAR ..... MG CMLC03 MSXW



### MIXOLOGY BAR STATION

Designed to accommodate the most sophisticated Mixologists, this is the ultimate design element for a show-stopping cocktail mixing experience. (shown with optional Charcoal-Black quick covers)

MG CMLC07 GSBW



### DOUBLE BAR STATION

The Double Bar allows serving beverages to guests anytime, anywhere. This portable yet classy design does it all.

(shown with optional Golden-Brown quick covers)

MG CMLC11 BBXF



## DAY & NIGHT

Modular stations can perfectly display breakfast buffets or help entertain guests at the next cocktail party.



**CLASSIC PLUS** MG CMLB13 WSXW  
(shown with optional Golden-Brown quick cover)



**PRO BAR** MG CMLC05 MSXW  
(shown with optional Silver-Grey quick covers)



**STREAMLINE ARCH INDUCTION STATION** MG CMLD05 MSXW  
 (shown with optional Charcoal-Black quick covers and the Blackboard Collection)

## WARMING AND COOKING STATIONS

The visual appeal of the colors and textures of the food, the aroma as it is prepared, and the sounds of sizzling pans... Cooking and Warming Stations generate excitement, curiosity, and can be a great catalyst for social interaction.

Now, Cooking and Warming Stations are redesigned as one modern and beautifully crafted element to seamlessly blend with your hospitality design standards. Designed as a modular extension to our existing function-based tabletops, Mogogo Cooking and Warming Stations offer your chefs high-functionality, mobility, and add a sense of theater for a special catering experience.

Your guests want creativity and variety. Introduce them to new culinary territories and let them discover new sensations with Mogogo's Cooking and Warming Stations.



## MATERIAL GUIDE

Customize your Modular Stations by choosing from the different colors and finishes available.

Simply choose your preferred design combination by inserting the corresponding letter to its designated space as demonstrated below.

Item code	Design combination			
MG C#####	TOP	SEGMENT	TEXTILE	BASE
<b>M</b> Nero Marquina Marble BHP	<b>S</b> Brushed Stainless Steel	<b>W</b> Blue and White stripes	<b>F</b> Adjustable legs	
<b>G</b> Grey Slate BHP	<b>B</b> Brushed Brass	<b>B</b> Black	<b>W</b> Casters	
<b>W</b> Bengali Mango Wood BHP				
<b>*B</b> * High Density Bamboo * High Density Bamboo				

EXAMPLE:

MG CMLB10 GBWF =

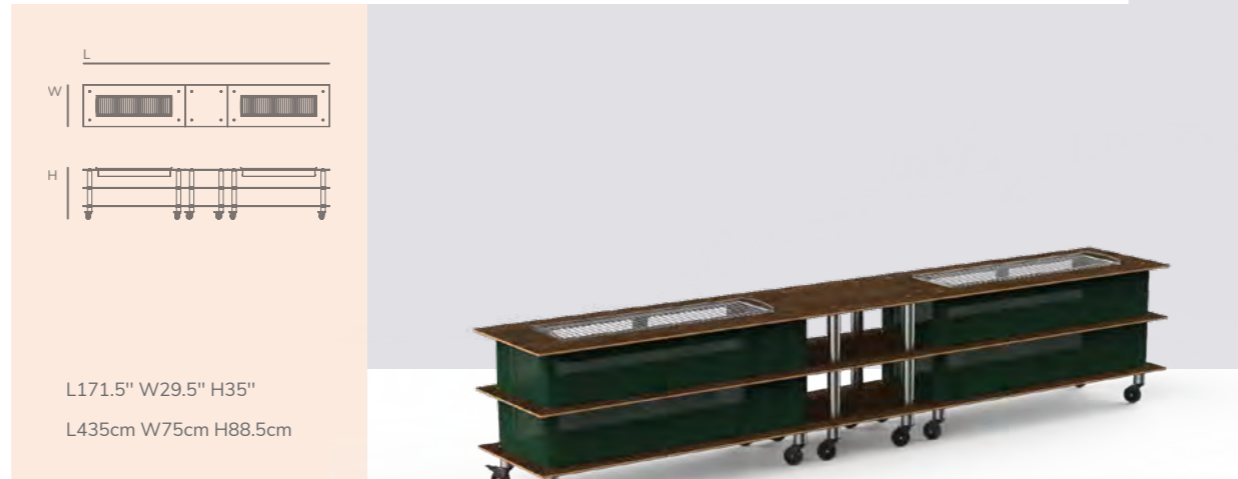

### DOUBLE HEAT BUFFET TABLE

No need for a plug. This station uses canned heat to keep food warm during entire events.

(shown with optional Jungle-Green quick covers)

MG CMLD04 WSXW

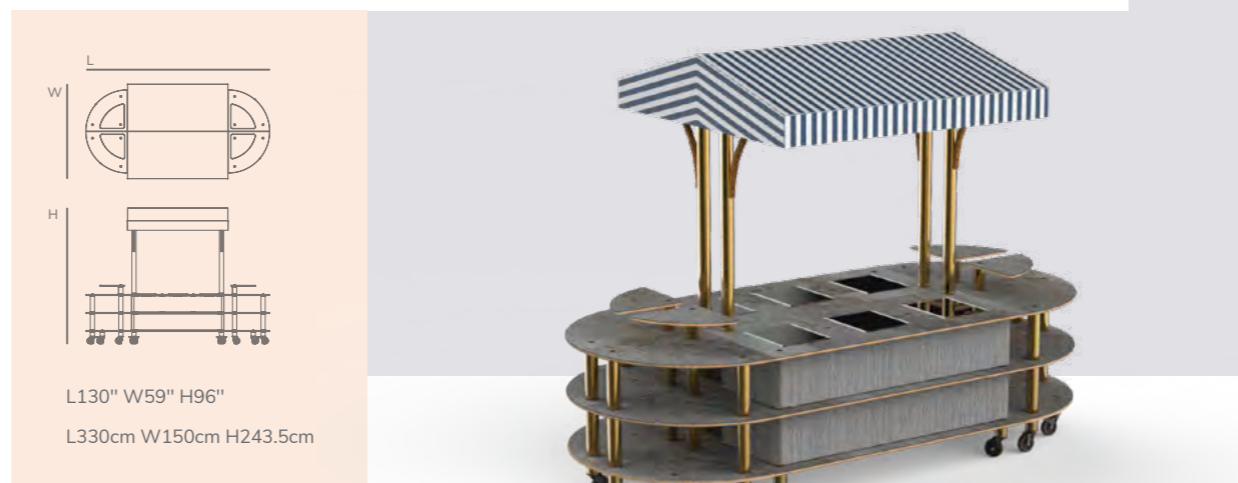

### ROUNDED WARMING INDUCTION MARKET STATION

This stand-out station makes serving large crowds easy while keeping food warm on six drop-in induction units.

(shown with optional Silver-Grey quick covers)

MG CMLD03 GBWW



### PRO COOKING INDUCTION

Drop-in cooking induction ranges give the freedom to bring a kitchen atmosphere within an event space for unique interactions with guests.

(shown with optional Charcoal-Black quick covers)

MG CMLD01 MSXW



### LARGE ARCH INDUCTION STATION

Combining drop-in induction ranges with additional space for mise en place; the ultimate comfort for chefs.

(shown with optional Golden-Brown quick covers and Long Blackboard)

MG CMLD02 BSXW





**HEAT TABLE** MG CMLD06 WSXW  
(shown with optional Golden-Brown quick covers)



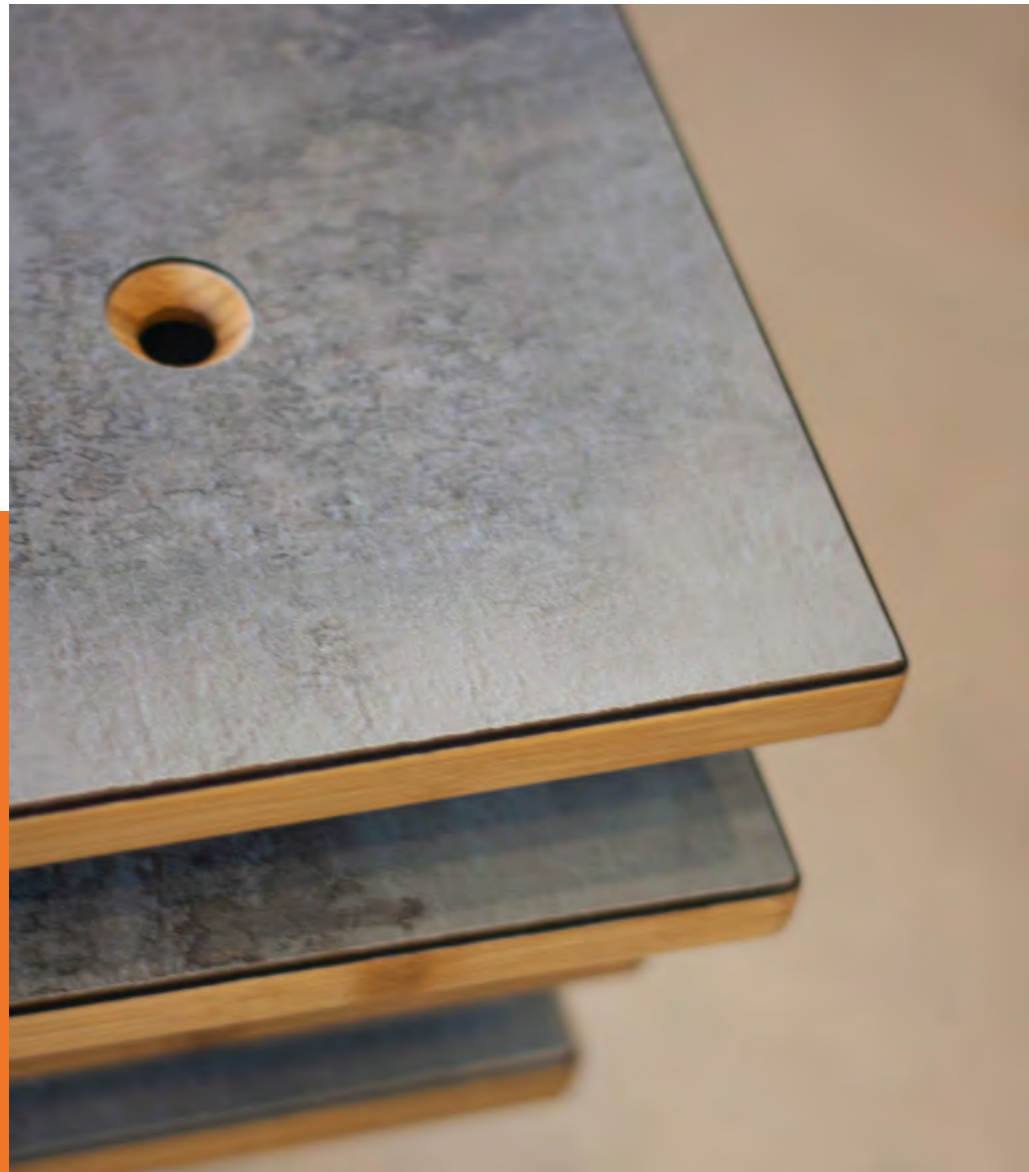

## TRANSFER & STORAGE CARTS

Designed for convenience and mobility, Mogogo's utility carts are an integral part of the Modular system as they make storing and assembling the stations an easy task. Whether it is to push them through the halls, or get in and out of elevators, they make the behind the scenes of your time-sensitive events easier and give you an extra push on productivity.

The carts can store up to five large Classic units or four large Creative units while the orange vinyl coated areas ensure comprehensive tabletop protection.

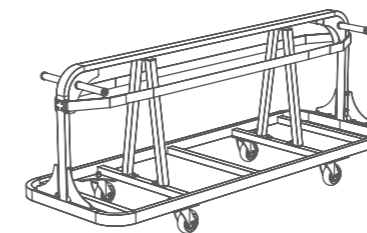

**LARGE PLATE  
TRANSFER AND STORAGE CART**  
L86.5" W31" H36.5"  
L220cm W79cm H92.5cm  
holds up to 18 tabletops

MG CUUX03 XXXX



**SEGMENTS AND ADD-ONS  
TRANSFER AND STORAGE CART**  
L55.5" W31" H50"  
L141cm W79cm H127.5cm  
holds 7-9 modular unit segments and legs/casters  
+ dedicated storage space for multiple modular add-ons

MG CUUX01 XXXX



71" BREATH GUARD MG CIAN01 XSXX











## SYSTEM BREAKDOWN

Mogogo's Modular System is based on a wide range of individual parts, which can be stacked up & assembled to design a variety of stations.

Our Modular System stems from the simple idea that your F&B Furniture should adapt to your ever-varying needs during different event sizes, types, and themes. It allows you to pick and choose basic elements such as tabletops, leg segments, casters, shelves, and other add-ons.

Endless vertical and horizontal possibilities exist while choosing between our functional tabletops: from classic to cooking, warming and bar tabletops, or picking your material and finishes of choice. Mogogo's Modular System gifts you an ocean of possibilities.

## MOGOGO TOOLS

	1 piece	ALLEN KEY FOR M16	MG SAUXSS 0101
	1 piece	M16 SCREWS	MG SSCWMT 0101
 	1 piece	BLACK SCREW CAP	MG SSACPL 0601
 	1 piece	GREY SCREW CAP	MG SSACPL 0501
 	1 piece	BROWN SCREW CAP	MG SSACPI 0201
 X1  X2  X12		UTILITY KIT: ALLEN KEY FOR M16 2 M16 SCREWS 12 SCREW CAPS (4 Screw caps X 3 colors)	MG SSACSM 0102







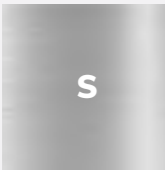

## MATERIAL GUIDE

Customize your Modular Stations by choosing from the different colors and finishes available.

Simply choose your preferred design combination by inserting the corresponding letter to its designated space as demonstrated below.

Item code: MG C#####

Design combination: TOP SEGMENT TEXTILE BASE

TOP	SEGMENT	TEXTILE	BASE
 M Nero Marquina Marble BHP	 S Brushed Stainless Steel	 W Blue and White stripes	 F Adjustable legs
 G Grey Slate BHP	 B Brushed Brass	 B Black	 W Casters
 W Bengali Mango Wood BHP			

 \* B

\* High-Density Bamboo finish only available in North America

\* High Density Bamboo

EXAMPLE:

MG CMLB10 GBWF =



## CREATIVE RANGE

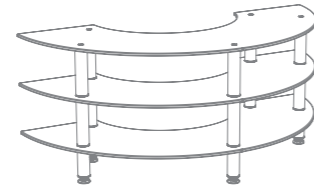

**CREATIVE CURVED UNIT**  
L81.5" W41" H35"  
L207cm W104cm H88.5cm

MG CMSX01 \_\_ X \_

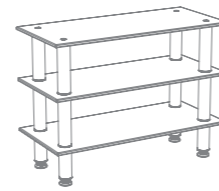

**CREATIVE EXTENSION UNIT**  
L47" W21" H35"  
L120cm W54cm H88.5cm

MG CMSX02 \_\_ X \_

## CLASSIC RANGE

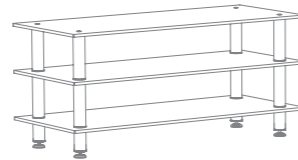

**CLASSIC LARGE UNIT**  
L71" W29.5" H35"  
L180cm W75cm H88.5cm

MG CMLX01 \_\_ X \_



**CLASSIC MEDIUM UNIT**  
L47" W29.5" H35"  
L120cm W75cm H88.5cm

MG CMLX02 \_\_ X \_

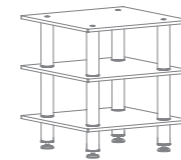

**CLASSIC SMALL UNIT**  
L29.5" W29.5" H35"  
L75cm W75cm H88.5cm

MG CMLX03 \_\_ X \_



**CLASSIC CORNER UNIT**  
L29.5" W29.5" H35"  
L75cm W75cm H88.5cm

MG CMLX04 \_\_ X \_

## STANDARD RANGE

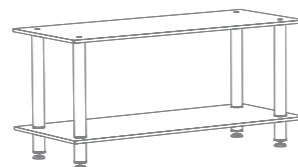

**STANDARD LARGE UNIT**  
L71" W29.5" H35"  
L180cm W75cm H88.5cm

MG CMDX01 \_\_ X \_

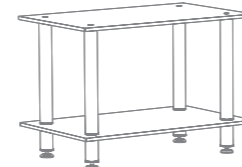

**STANDARD MEDIUM UNIT**  
L47" W29.5" H35"  
L120cm W75cm H88.5cm

MG CMDX02 \_\_ X \_

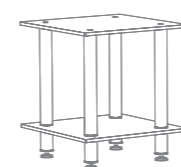

**STANDARD SMALL UNIT**  
L29.5" W29.5" H35"  
L75cm W75cm H88.5cm

MG CMDX03 \_\_ X \_

## CREATIVE RANGE SHELVES

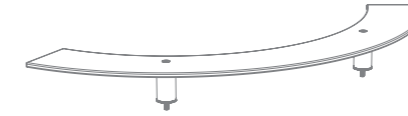

**CURVED OUTER SHELF**  
L76" W27.5" H6.5"  
L193cm W70cm H16.5cm

MG CIAF01 \_\_ XX



**CURVED INNER SHELF**  
L53" W26.5" H6.5"  
L135cm W68cm H16.5cm

MG CIAF02 \_\_ XX



**EXTENSION SHELF**  
L47" W10" H6.5"  
L120cm W25cm H16.5cm

MG CIAF03 \_\_ XX

## CLASSIC RANGE SHELVES

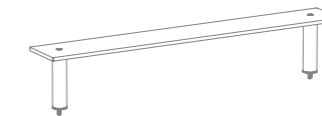

**LARGE SHELF**  
L71" W9.5" H12.5"  
L180cm W24cm H32cm

MG CIAF04 \_\_ XX

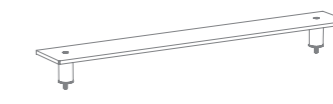

**LARGE LOW SHELF**  
L71" W9.5" H6.5"  
L180cm W24cm H16.5cm

MG CIAF05 \_\_ XX



**LARGE WIDE BAR SHELF**  
L71" W14.5" H12.5"  
L180cm W37cm H32cm

MG CIAF06 \_\_ XX



**MEDIUM SHELF**  
L47" W9.5" H12.5"  
L120cm W24cm H32cm

MG CIAF07 \_\_ XX

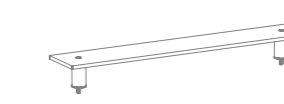

**MEDIUM LOW SHELF**  
L47" W9.5" H6.5"  
L120cm W24cm H16.5cm

MG CIAF08 \_\_ XX

## MATERIAL GUIDE

Customize your Modular Stations by choosing from the different colors and finishes available.

Simply choose your preferred design combination by inserting the corresponding letter to its designated space as demonstrated below.

Item code	Design combination			
MG C#####	TOP	SEGMENT	TEXTILE	BASE
	<b>TOP</b>	<b>SEGMENT</b>	<b>TEXTILE</b>	<b>BASE</b>
<b>M</b> Nero Marquina Marble BHP	<b>S</b> Brushed Stainless Steel	<b>W</b> Blue and White stripes	<b>F</b> Adjustable legs	
<b>G</b> Grey Slate BHP	<b>B</b> Brushed Brass	<b>B</b> Black	<b>W</b> Casters	
<b>W</b> Bengali Mango Wood BHP				
<b>*B</b> * High-Density Bamboo finish only available in North America				
<b>* High Density Bamboo</b>				

EXAMPLE:

MG CMLB10 **GBWF** =



## CLASSIC RANGE DISPLAY SHELVES

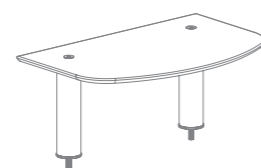

**HIGH SIDE SHELF**  
L29.5" W19" H12.5"  
L75cm W47.5cm H32cm

MG CIAY01 \_\_ XX



**LOW SIDE SHELF**  
L29.5" W19" H6.5"  
L75cm W47.5cm H16.5cm

MG CIAY02 \_\_ XX



**WIDE DISPLAY SHELF**  
L80" W12" H12.5"  
L203cm W30.5cm H32cm  
connects 2 mid-hole display tabletops

MG CIAY03 \_\_ XX

## DISPLAY SHELVES

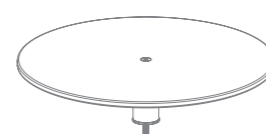

**30" ROUND  
LOW DISPLAY SHELF**  
Ø30" H6.5"  
Ø76cm H16.5cm

MG CIAY04 \_\_ XX

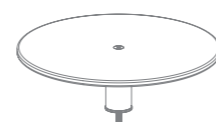

**24" ROUND  
LOW DISPLAY SHELF**  
Ø24" H6.5"  
Ø60cm H16.5cm

MG CIAY05 \_\_ XX

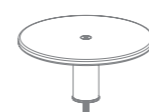

**18" ROUND  
LOW DISPLAY SHELF**  
Ø18" H6.5"  
Ø46cm H16.5cm

MG CIAY06 \_\_ XX

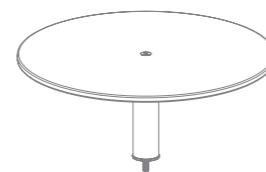

**30" ROUND  
HIGH DISPLAY SHELF**  
Ø30" H12.5"  
Ø76cm H32cm

MG CIAY07 \_\_ XX

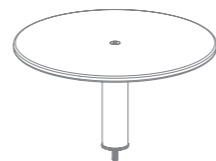

**24" ROUND  
HIGH DISPLAY SHELF**  
Ø24" H12.5"  
Ø60cm H32cm

MG CIAY08 \_\_ XX

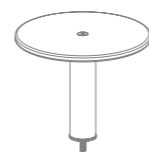

**18" ROUND  
HIGH DISPLAY SHELF**  
Ø18" H12.5"  
Ø46cm H32cm

MG CIAY09 \_\_ XX

## DISPLAY SHELVES

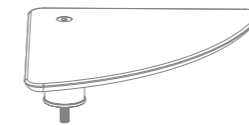

**LARGE TRIANGLE  
LOW DISPLAY SHELF**  
L17" W17" H6.5"  
L44cm W44cm H16.5cm

MG CIAY10 \_\_ XX

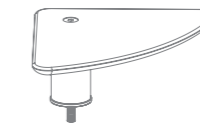

**SMALL TRIANGLE  
LOW DISPLAY SHELF**  
L14" W14" H6.5"  
L35cm W35cm H16.5cm

MG CIAY11 \_\_ XX

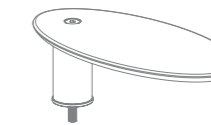

**LARGE OVAL  
LOW DISPLAY SHELF**  
L20" W10" H6.5"  
L50cm W25cm H16.5cm

MG CIAY14 \_\_ XX

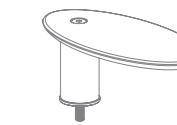

**SMALL OVAL  
LOW DISPLAY SHELF**  
L16" W8" H6.5"  
L40cm W20cm H16.5cm

MG CIAY15 \_\_ XX

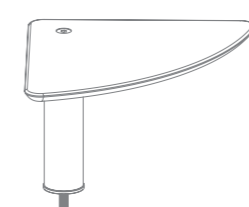

**LARGE TRIANGLE  
HIGH DISPLAY SHELF**  
L17" W17" H12.5"  
L44cm W44cm H32cm

MG CIAY12 \_\_ XX

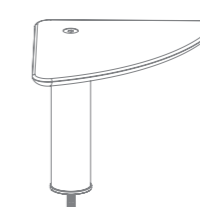

**SMALL TRIANGLE  
HIGH DISPLAY SHELF**  
L14" W14" H12.5"  
L35cm W35cm H32cm

MG CIAY13 \_\_ XX

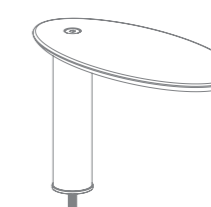

**LARGE OVAL  
HIGH DISPLAY SHELF**  
L20" W10" H12.5"  
L50cm W25cm H32cm

MG CIAY16 \_\_ XX

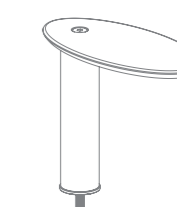

**SMALL OVAL  
HIGH DISPLAY SHELF**  
L16" W8" H12.5"  
L40cm W20cm H32cm

MG CIAY17 \_\_ XX



## MATERIAL GUIDE

Customize your Modular Stations by choosing from the different colors and finishes available.

Simply choose your preferred design combination by inserting the corresponding letter to its designated space as demonstrated below.

Item code: MG C#####

Design combination: TOP SEGMENT TEXTILE BASE

TOP	SEGMENT	TEXTILE	BASE
<b>M</b> Nero Marquina Marble BHP	<b>S</b> Brushed Stainless Steel	<b>W</b> Blue and White stripes	<b>F</b> Adjustable legs
<b>G</b> Grey Slate BHP	<b>B</b> Brushed Brass	<b>B</b> Black	<b>W</b> Casters
<b>W</b> Bengali Mango Wood BHP			
<b>*B</b> * High-Density Bamboo * High Density Bamboo			

\* High-Density Bamboo finish only available in North America

EXAMPLE:

MG CMLB10 **GBWF** =



## ADD-ONS

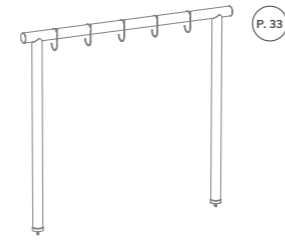

**ARCH**  
L71" W3" H61"  
L180cm W7.6cm H155cm  
Fits large units

MG CIAM02 X\_XX



**CANOPY**  
L71" W33.5" H61"  
L180cm W85cm H155cm  
Fits large units

MG CIAM03 X\_\_X

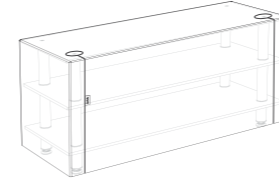

**OUTDOOR CORDURA COVER**  
Fits classic large unit

MG SADDCR 0401

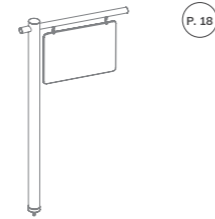

**SIGN POST**  
L32" W3" H59"  
L80.5cm W7.6cm H150cm  
Fits all units

MG CIAM01 X\_XX

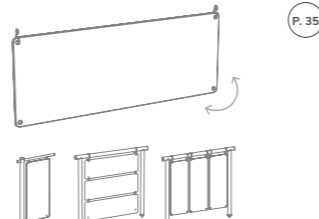

**LONG BLACKBOARD**  
L47" H18"  
L120cm H45cm  
Fits Arch and Sign post

MG SADDSM 0201



**BLACKBOARD COLLECTION**  
5X various shapes  
Fits Arch

MG SADDSM 0301

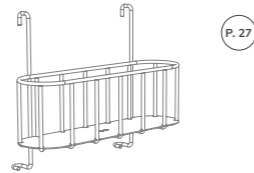

**SPEEDRAIL**  
L18.5" W5" H14"  
L47cm W13cm H36cm  
Fits bar top

MG SADDSS 0602

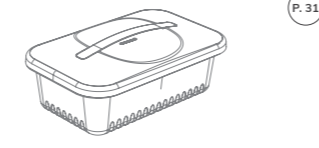

**MOGOGO ICE BIN**  
L19.5" H12.5" W8"  
L49.5cm H31cm W20cm  
Fits Pro bar top

MG SADDPL 0301

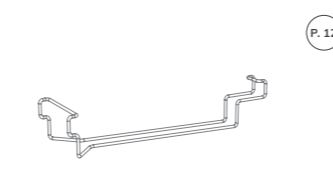

**WINE GLASS HOLDER**  
L15" H2.5" W4.5"  
L37.5cm H6.5cm W11cm  
Fits Large wide bar shelf  
Holds up to 6 wine glasses

MG SADDSS 1301

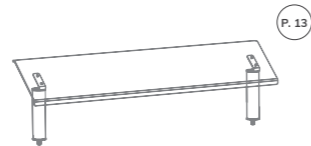

**71" BREATH GUARD**  
H18.5" | gap H8.5"  
H47cm | gap H22cm  
Fits large units

MG CIAN01 X\_XX

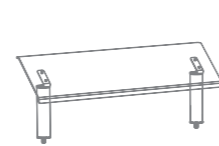

**47" BREATH GUARD**  
H18.5" | gap H8.5"  
H47cm | gap H22cm  
Fits medium units

MG CIAN02 X\_XX

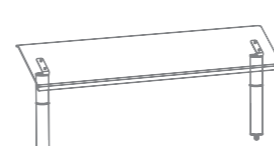

**71" HIGH BREATH GUARD**  
H24.5" | gap H14"  
H62cm | gap H36.5cm  
Fits large units

MG CIAN03 X\_XX

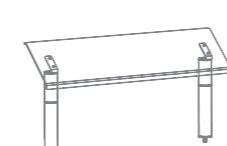

**47" HIGH BREATH GUARD**  
H24.5" | gap H14"  
H62cm | gap H36.5cm  
Fits medium units

MG CIAN04 X\_XX

## QUICK COVERS

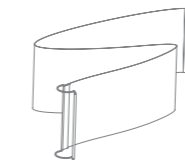

Fits Unit	Amount	Golden-Brown	Silver-Grey	Charcoal-Black	Jungle-Green
LARGE CLASSIC UNIT	2	MG SQCOPV 0301	MG SQCOPV 0401	MG SQCOPV 1601	MG SQCOGP 0201
MEDIUM CLASSIC UNIT	2	MG SQCOPV 0501	MG SQCOPV 0601	MG SQCOPV 1701	MG SQCOGP 0301
SMALL CLASSIC UNIT	2	MG SQCOPV 0701	MG SQCOPV 0801	MG SQCOPV 1801	MG SQCOGP 0401
CORNER CLASSIC UNIT	2	MG SQCOPV 2401	MG SQCOPV 2501	MG SQCOPV 2601	MG SQCOGP 1101
CURVED CREATIVE UNIT	2	MG SQCOPV 0901	MG SQCOPV 1001	MG SQCOPV 1901	MG SQCOGP 0501
EXTENSION CREATIVE UNIT	2	MG SQCOPV 1101	MG SQCOPV 1201	MG SQCOPV 2001	MG SQCOGP 0601
LARGE SHELF COVER	1	MG SQCOPV 0101	MG SQCOPV 0201	MG SQCOPV 1501	MG SQCOGP 0101

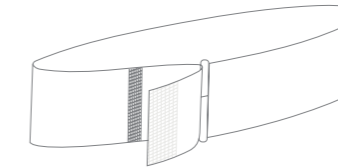

## 360° QUICK COVERS

LARGE CLASSIC UNIT	2	MG SQCOPV 3401	MG SQCOPV 3301	MG SQCOPV 3201	MG SQCOGP 0801
--------------------	---	----------------	----------------	----------------	----------------

## SEGMENTS



Brushed Stainless Steel

Brushed Brass



**5.7" SEGMENT**  
H5.7" | H14cm  
available in sets of:  
1 / 2

1 piece	MG SLEGSS 0201	MG SLEGBR 0401
2 pcs	MG SLEGSS 0501	MG SLEGBR 0901



**12" SEGMENT**  
H12" | H30cm  
available in sets of:  
1 / 2 / 8

1 piece	MG SLEGSS 0101	MG SLEGBR 0301
2 pcs	MG SLEGSS 0401	MG SLEGBR 0801
8 pcs	MG SLEGSS 1501	MG SLEGBR 1001



**STANDARD SEGMENT**  
H25" | H63cm  
available in sets of:  
1 / 4

1 piece	MG SLEGSS 1701	MG SLEGBR 1401
4 pcs	MG SLEGSS 1801	MG SLEGBR 1501

## LEGS

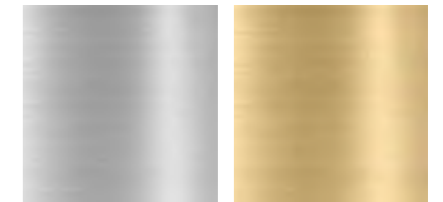

Brushed Stainless Steel

Brushed Brass



**ADJUSTABLE LEGS**  
available in sets of:  
1 single leg / 4 legs

1 piece	MG SLEGSS 1301	MG SLEGBR 0101
4 pcs	MG SLEGSS 1401	MG SLEGBR 0201

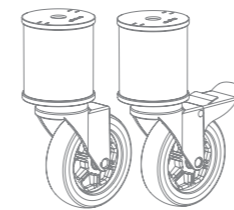

**CASTERS**  
available in sets of:  
1 with brake / without brake  
4 casters (2 with brakes and 2 without)

1 piece with brake	MG SADDSS 0404	MG SADDBR 0604
1 piece without brake	MG SADDSS 0304	MG SADDBR 0504
4 pcs	MG SADDSS 0104	MG SADDBR 0404



## CLASSIC RANGE TABLETOPS



\* High density Bamboo

Bengali Mango Wood BHP

Grey Slate BHP

Nero Marquina Marble BHP



MG SCTPBM 0102 MG SCTPHW 0101 MG SCTPHG 0101 MG SCTPHB 0101

**LARGE RECTANGLE TOP**  
L71" W29.5"  
L180cm W75cm



MG SCTPBM 0202 MG SCTPHW 0201 MG SCTPHG 0201 MG SCTPHB 0201

**MEDIUM RECTANGLE TOP**  
L47" W29.5"  
L120cm W75cm

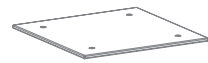

MG SCTPBM 0302 MG SCTPHW 0301 MG SCTPHG 0301 MG SCTPHB 0301

**SMALL SQUARE TOP**  
L29.5" W29.5"  
L75cm W75cm

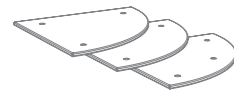

MG CILX01 BXXX MG CILX01 WXXX MG CILX01 GXXX MG CILX01 MXXX

**CORNER UNIT TOP SET**  
L29.5" W29.5"  
L75cm W75cm

## CLASSIC RANGE SHELF TOPS

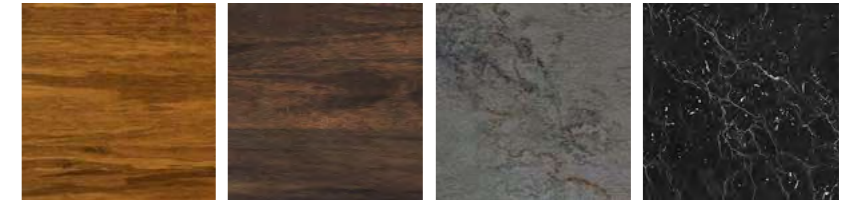

\* High density Bamboo

Bengali Mango Wood BHP

Grey Slate BHP

Nero Marquina Marble BHP

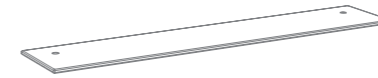

MG SCLSBM 0202 MG SCLSHW 0201 MG SCLSHG 0201 MG SCLSHB 0201

**LARGE WIDE BAR SHELF**  
L71" W14.5"  
L180cm W37cm



MG SCLSBM 0102 MG SCLSHW 0101 MG SCLSHG 0101 MG SCLSHB 0101

**LARGE SHELF**  
L71" W9.5"  
L180cm W24cm



MG SCLSBM 0302 MG SCLSHW 0301 MG SCLSHG 0301 MG SCLSHB 0301

**MEDIUM SHELF**  
L47" W9.5"  
L120cm W24cm



MG SSTPBM 0101 MG SCLSHW 0501 MG SCLSHG 0501 MG SCLSHB 0501

**WIDE DISPLAY SHELF**  
L80" W12"  
L203cm W30.5cm  
connects 2 mid-hole display tabletops



MG SCSVBM 0501 MG SCLSHW 0801 MG SCLSHG 0801 MG SCLSHB 0801

**SIDE SHELF**  
L29.5" W19"  
L75cm W47.5cm

## CREATIVE RANGE TABLETOPS



\* High density Bamboo    Bengali Mango Wood BHP    Grey Slate BHP    Nero Marquina Marble BHP



MG SCTBBM 0101    MG SCTBHW 0101    MG SCTBHG 0101    MG SCTBHB 0101

**LARGE ROUND TOP**  
L81.5" W41"  
L207cm W104cm



MG SCTBBM 0201    MG SCTBHW 0201    MG SCTBHG 0201    MG SCTBHB 0201

**47" EXTENSION TOP**  
L47" W21"  
L120cm W54cm

## CREATIVE RANGE SHELF TOPS



MG SCSVBM 0101    MG SCSVHW 0101    MG SCSVHG 0101    MG SCSVHB 0101

**CURVED OUTER SHELF**  
L76" W27.5"  
L193cm W70cm



MG SCSVBM 0201    MG SCSVHW 0201    MG SCSVHG 0201    MG SCSVHB 0201

**CURVED INNER SHELF**  
L53" W26.5"  
L135cm W68cm



MG SCLSBM 0401    MG SCSVHW 0801    MG SCSVHG 0801    MG SCSVHB 0801

**EXTENSION SHELF**  
L47" W10"  
L120cm W25cm

## DISPLAY SHELF TOPS FOR CLASSIC AND CREATIVE RANGE



\* High density Bamboo    Bengali Mango Wood BHP    Grey Slate BHP    Nero Marquina Marble BHP

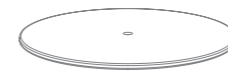

MG SCRTBM 0102    MG SCRTHW 0101    MG SCRTHG 0101    MG SCRTHB 0101

**30" ROUND TOP**  
Ø30" | Ø76cm



MG SCRTBM 0202    MG SCRTHW 0201    MG SCRTHG 0201    MG SCRTHB 0201

**24" ROUND TOP**  
Ø24" | Ø60cm

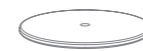

MG SCRTBM 0302    MG SCRTHW 0301    MG SCRTHG 0301    MG SCRTHB 0301

**18" ROUND TOP**  
Ø18" | Ø46cm



MG SCSVBM 0601    MG SCLSHW 0601    MG SCLSHG 0601    MG SCLSHB 0601

**LARGE TRIANGLE DISPLAY SHELF**  
L17" W17" | L44cm W44cm

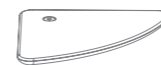

MG SCSVBM 0701    MG SCLSHW 0701    MG SCLSHG 0701    MG SCLSHB 0701

**SMALL TRIANGLE DISPLAY SHELF**  
L14" W14" | L35cm W35cm



MG SCSVBM 0301    MG SSLFHW 0301    MG SSLFHG 0301    MG SSLFHB 0301

**LARGE OVAL DISPLAY SHELF**  
L20" W10" | L50cm W25cm



MG SCSVBM 0401    MG SSLFHW 0401    MG SSLFHG 0401    MG SSLFHB 0401

**SMALL OVAL DISPLAY SHELF**  
L16" W8" | L40cm W20cm



## MATERIAL GUIDE

Customize your Modular Stations by choosing from the different colors and finishes available.

Simply choose your preferred design combination by inserting the corresponding letter to its designated space as demonstrated below.

Item code	Design combination			
MG C#####	TOP	SEGMENT	TEXTILE	BASE
	<b>M</b>	<b>S</b>	<b>W</b>	<b>F</b>
	Nero Marquina Marble BHP	Brushed Stainless Steel	Blue and White stripes	Adjustable legs
	<b>G</b>	<b>B</b>	<b>B</b>	<b>W</b>
	Grey Slate BHP	Brushed Brass	Black	Casters
	<b>W</b>			
	Bengali Mango Wood BHP			
	<b>*B</b>			
	* High-Density Bamboo finish only available in North America			
	* High Density Bamboo			

EXAMPLE:  
MG CMLB10 **GBWF** =



## CLASSIC RANGE STAINLESS STEEL SPECIAL TABLETOPS KITS



Brushed Stainless Steel

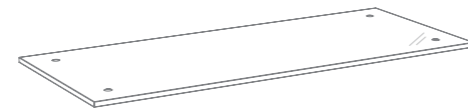

**STAINLESS STEEL TOP**  
L71" W29.5"  
L180cm W75cm

MG SSTPSS 0301

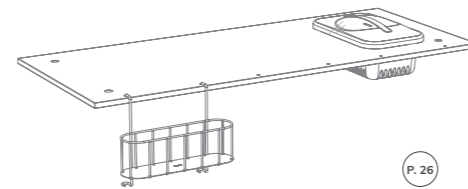

**PRO BAR TOP**  
L71" W29.5" | L180cm W75cm  
Ice Bin: L16" W9" D6"  
L41.5cm W23cm D15cm

MG CITC01 SXXX



**SALAD-BAR TOP**  
L71" W29.5" | L180cm W75cm  
Ice Cooler: L48" W25" D6.5"  
L122cm W63cm D16cm

MG CITE01 SXXX

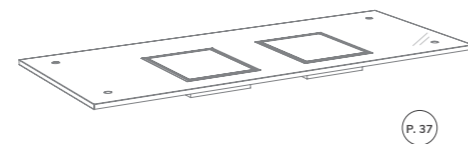

**COOKING DROP-IN TOP**  
L71" W29.5"  
L180cm W75cm

MG CITD01 SXXX

## CLASSIC RANGE STAINLESS STEEL SPECIAL TABLETOP UNITS

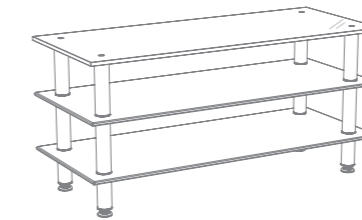

**LARGE PRO UNIT**  
L71" W29.5" H35"  
L180cm W75cm H88.5cm

MG CMLA05 \_ \_ X \_

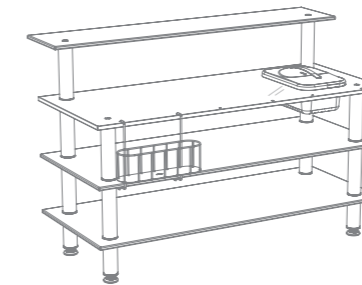

**PRO BAR**  
L71" W29.5" H47.5"  
L180cm W75cm H121cm

MG CMLC05 \_ \_ X \_

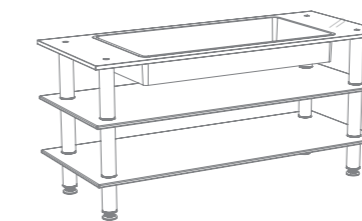

**SALAD-BAR UNIT**  
L71" W29.5" H35"  
L180cm W75cm H88.5cm

MG CMLE03 \_ \_ X \_

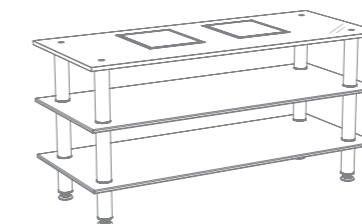

**PRO COOKING INDUCTION**  
L71" W29.5" H35"  
L180cm W75cm H88.5cm

MG CMLD01 \_ \_ X \_









## MATERIAL GUIDE

Customize your Modular Stations by choosing from the different colors and finishes available.

Simply choose your preferred design combination by inserting the corresponding letter to its designated space as demonstrated below.

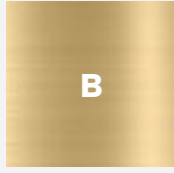
Item code: MG C#####

Design combination: TOP SEGMENT TEXTILE BASE

TOP	SEGMENT	TEXTILE	BASE
 <b>M</b> Nero Marquina Marble BHP	 <b>S</b> Brushed Stainless Steel	 <b>W</b> Blue and White stripes	 <b>F</b> Adjustable legs
 <b>G</b> Grey Slate BHP	 <b>B</b> Brushed Brass	 <b>B</b> Black	 <b>W</b> Casters
 <b>W</b> Bengali Mango Wood BHP	* High-Density Bamboo finish only available in North America		
 <b>*B</b> * High-Density Bamboo			

EXAMPLE:

MG CMLB10 GBWF =



## CLASSIC RANGE SPECIAL TABLETOP KITS

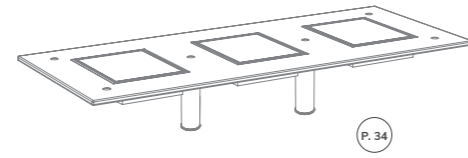

**WARMING TRIPLE DROP-IN TOP**  
L71" W29.5" | L180cm W75cm  
Comes with 2 x 12" support segment

MG CITD02 \_ \_ XX

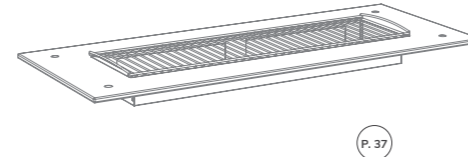

**HEAT TABLETOP**  
L71" W29.5" | L180cm W75cm  
Grill: L48" W25" D6.5"  
L122cm W63cm D16cm

MG CITD04 \_ XXX

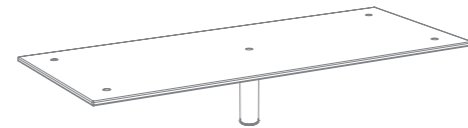

**MID-HOLE DISPLAY TABLETOP**  
L71" W29.5" | L180cm W75cm  
Comes with 1 x 12" support segment

MG CITB01 \_ \_ XX

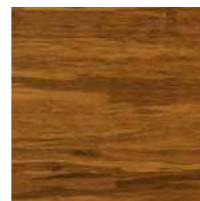

High Density Bamboo

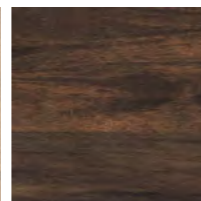

Bengali Mango Wood BHP



Grey Slate BHP

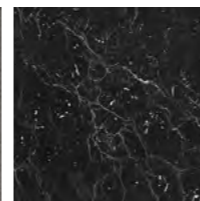

Nero Marquina Marble BHP

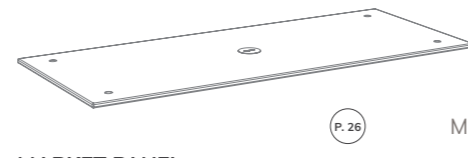

**MARKET PANEL**  
(Only for Market Square)  
L71" W29.5" | L180cm W75cm

MG SSTPBM 0503

MG SSTPHW 0501

MG SSTPHG 0501

MG SSTPHB 0501

## CLASSIC RANGE SPECIAL TABLETOP UNITS

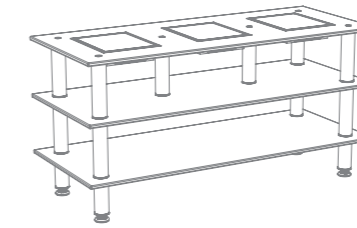

**TRIPLE WARMING UNIT**  
L71" W29.5" H35"  
L180cm W75cm H88.5cm

MG CMLD07 \_ \_ X \_

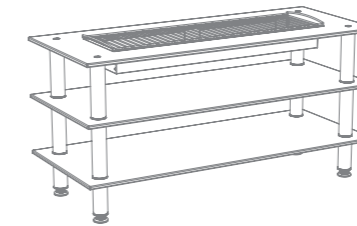

**HEAT TABLE**  
L71" W29.5" H35"  
L180cm W75cm H88.5cm

MG CMLD06 \_ \_ X \_

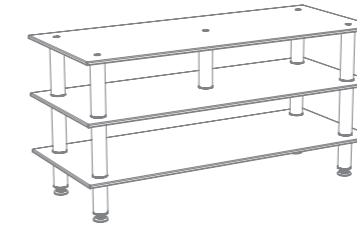

**MID-HOLE DISPLAY UNIT**  
L71" W29.5" H35"  
L180cm W75cm H88.5cm

MG CMLB09 \_ \_ X \_



mogogo  
BUFFET SOLUTIONS



ROLLIN  
SERVICE CARTS

2022/2023

DISTRIBUTED BY:  steelite  
INTERNATIONAL



**SERVICE CART** MG CRNX01 MSXX \ \ MG CRNX01 GSXX  
(shown with optional Charcoal-Black quick covers)

## INDEX

**NEW** New Products

 Waiter

 Bartender

 P. 20 See Page





A PROFESSIONAL  
FOOD & BEVERAGE  
FURNITURE COMPANY

# BORN FROM AN INTERDISCIPLINARY PASSION FOR **Design x Food**



Mogogo is led by designers and chefs that are driven by the desire to introduce new, beautiful, and functional products to the market, with an environmentally friendly philosophy in mind.

WE PUSH  
THE CREATIVE ENVELOPE  
OF FUNCTION AND INNOVATION.



LINENLESS



MODULAR



MOBILE



SUSTAINABLE



ADD ONS







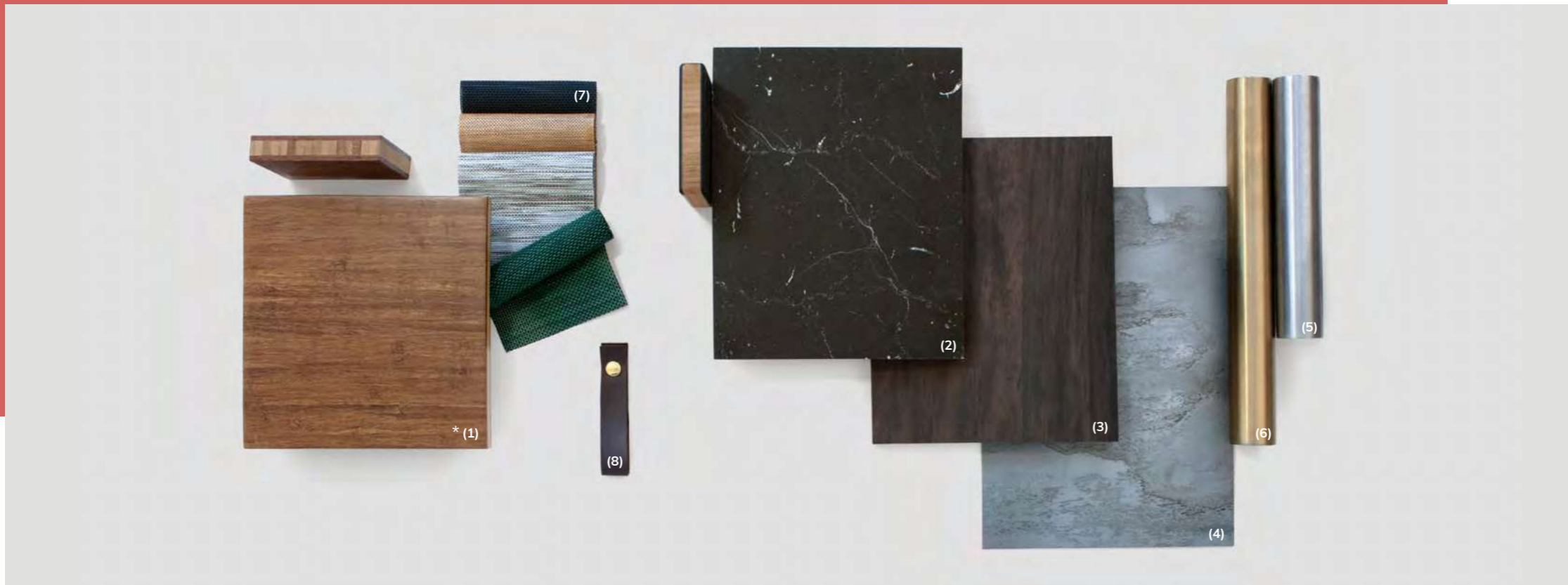

## ABOUT ROLL'N COLLECTION

Tableside Service is considered an exquisite service in the hospitality industry. A smaller unit on wheels with a sleek design is the ideal serving sidekick for your staff in any dining environment. Just like everything designed by Mogogo, the Roll'n Service Cart collection starts with a core element. It's an elegant and functional cart with high-density BHP panels, heavy-duty casters, and a slick leather covered handle for easier and more comfortable navigation. From there, Mogogo's designers developed a series of add-ons that can easily transform your service cart into a cheese serving cart, cocktail cart, and much more.

## MATERIALS

Joining our Bamboo (1)\* collection is our new innovative BHP material. BHP is a newly composed material that arrived after two years of intense R&D. It merges layers of High-Pressure Laminate with a Vertical Bamboo core (Mogogo's expertise) creating a lighter yet durable panel that offers new textures and colors. This new material combines the advantages of both bamboo and HPL, perfect for the ever-changing needs of the hospitality industry. Available in a variety of finishes that resemble natural materials such as Nero Marquina Marble, Bengali Mango Wood, and Grey Slate (2-4), making it easy to match with any event and decor.

The innovative bamboo core of the BHP goes in line with Mogogo's sustainability motto while the HPL's outer coating is durable for different environments, hygienic, and easy to clean.

Roll'n segments come in 2 finishes: brushed stainless steel (5) and brushed brass (6).

Easily cover up parts of your service carts with our original quick covers (7). Both durable and easy to clean, they come in 4 different color options allowing you to easily match any of your event color schemes.

All service carts come with a hand-stitched leather (8) handle which gives the carts a luxurious look and a comfortable functionality.

\* High-Density Bamboo finish only available in North America

## HOW IT WORKS

Delivered to you in flat packaging with all the needed parts, Roll'n Service Cart is specially designed for easy and fast assembly.

With a multi-purpose cart in mind, Mogogo's Service Cart was developed alongside a series of add-ons which can easily transform your standard service cart into a cheese serving cart, wine cart, cocktail cart, and more for any tableside service occasion. Add or remove Mogogo's add-ons, such as a cutting board, top rail border, wine glass holder, or ice and champagne bucket depending on your specific food service delivery need.

Functionality is key when it comes to the daily challenges of Food & Beverage professionals. For this specific reason, Mogogo's quick-covers are essential to quickly conceal the two lower layers for dishes or additional items you would like to hide from your guests in the most elegant way.

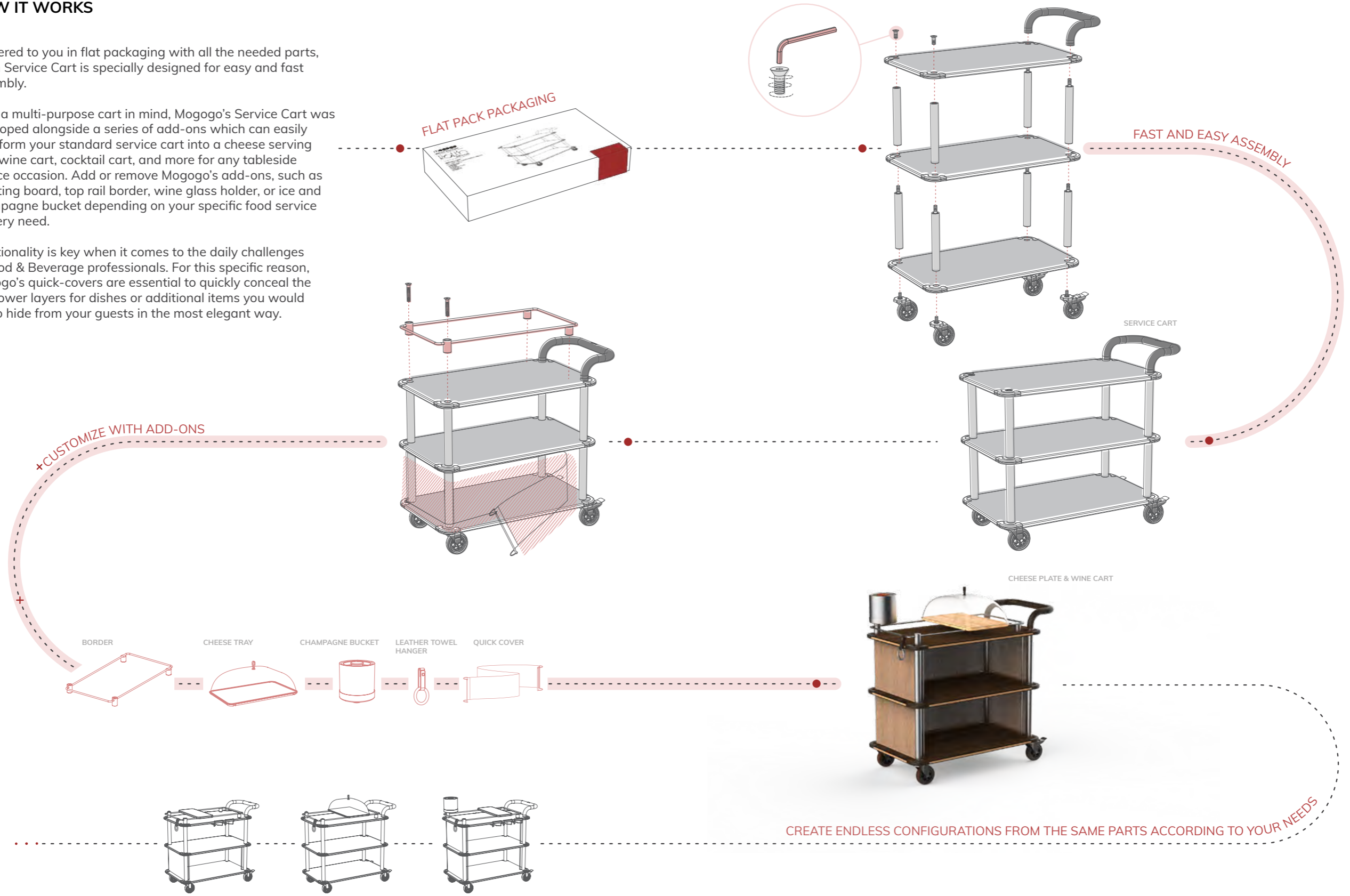





MG CRNX04 WBXX (shown with optional quick covers)



MG CRNX01 GBXX



# COLOR COMBINATIONS



MG CRNX03 MBXX (shown with optional quick cover)

With the different finishes, color combinations, and add-ons, you can easily change the vibe and take your service carts to .a whole new level



MG CRNX04 GSXX (shown with optional quick covers)



\*  
While the brass has a more elegant look the stainless gives .off a more modern one  
.All combinations are possible











MG CRNX01 MSXX (shown with optional quick covers)





## MATERIAL GUIDE

Customize your Roll'n Service Carts by choosing from the different colors and finishes available. Simply choose your preferred design combination by inserting the corresponding letter to its designated space as demonstrated below.

Item code	Design combination	
MG C#####	TOP	SEGMENT XX
		
	<b>TOP</b>	<b>SEGMENT</b>
		
	Nero Marquina Marble BHP	Brushed Stainless Steel
		
	Grey Slate BHP	Brushed Brass
		
	Bengali Mango Wood BHP	
		
	* High-Density Bamboo finish only available in North America	
	* High density Bamboo	

EXAMPLE:  
MG CRNX01 MSXX =



## SERVICE CART

A companion to Mogogo's full product range or a standalone cart for table side service, room service, display, or any other occasion.



(shown with optional Golden-Brown quick covers)

The three level service cart is equipped with panel bumpers to avoid unwanted wear and tear to the cart tops. Heavy-duty casters and a comfortable handle will allow easy navigation of the Roll'n Cart around any tricky event.

MG CRNX01 BSXX



MG CRNX01 WBXX  
(shown with optional Golden-Brown quick cover)

High-Density Bamboo finish only available in North America



## MATERIAL GUIDE

Customize your Roll'n Service Carts by choosing from the different colors and finishes available. Simply choose your preferred design combination by inserting the corresponding letter to its designated space as demonstrated below.

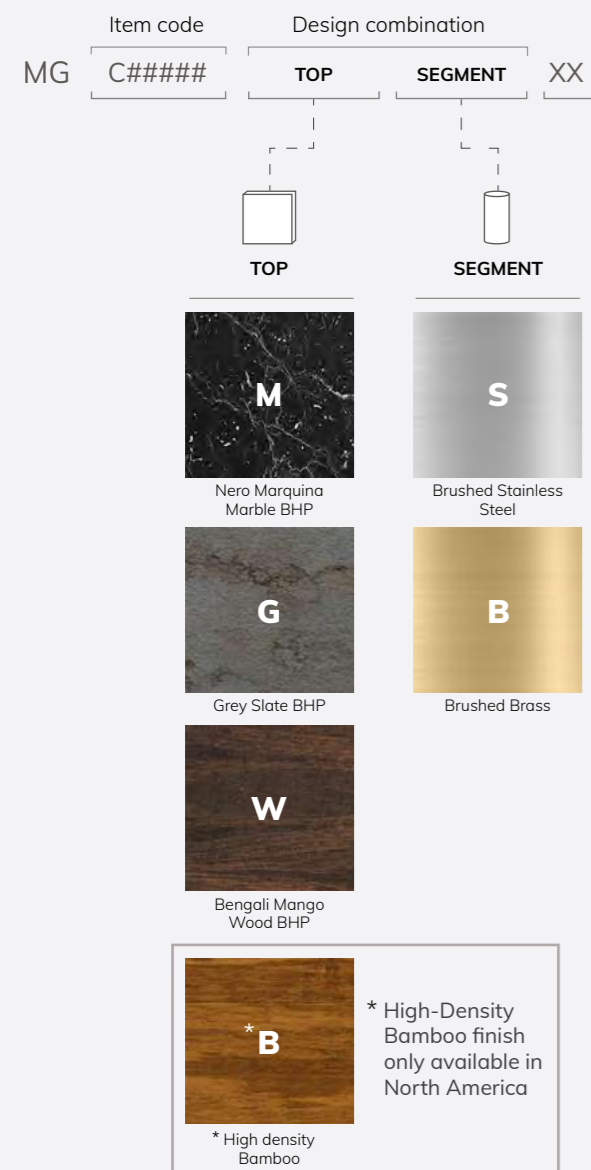

EXAMPLE:  
MG CRNX01 MSXX =



## TOP BORDER CART

Get that extra stability with a top border cart. Beautiful and chic while being extremely practical and useful for "on the move" service.



MG CRNX02 MSXX  
(shown with optional Charcoal-Black quick cover)



(shown with optional Jungle-Green quick covers)

The original Roll'n Service Cart customized with a border on the top level.







MG CRNX02 WBXX

High-Density Bamboo finish only available in North America



## MATERIAL GUIDE

Customize your Roll'n Service Carts by choosing from the different colors and finishes available. Simply choose your preferred design combination by inserting the corresponding letter to its designated space as demonstrated below.

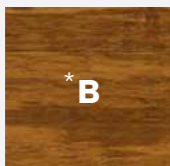
Item code	Design combination	
MG C#####	TOP	SEGMENT XX
		
	TOP	SEGMENT
		
	M Nero Marquina Marble BHP	S Brushed Stainless Steel
		
	G Grey Slate BHP	B Brushed Brass
		
	W Bengali Mango Wood BHP	
		
	* B * High density Bamboo	* High-Density Bamboo finish only available in North America

EXAMPLE:  
MG CRNX01 MSXX =



## CHEESE PLATE AND WINE CART

Bring your guests an authentic French Aperitif experience with our versatile Cheese and Wine Cart.



MG CRNX04 MSXX



(shown with optional Silver-Grey quick covers)

The original Roll'n Service Cart customized with a border, a cheese tray, a leather towel hanger, and a champagne bucket.

MG CRNX04 G\$XX





## MATERIAL GUIDE

Customize your Roll'n Service Carts by choosing from the different colors and finishes available. Simply choose your preferred design combination by inserting the corresponding letter to its designated space as demonstrated below.

Item code: MG C#####

Design combination: TOP SEGMENT XX

TOP	SEGMENT
<b>M</b> Nero Marquina Marble BHP	<b>S</b> Brushed Stainless Steel
<b>G</b> Grey Slate BHP	<b>B</b> Brushed Brass
<b>W</b> Bengali Mango Wood BHP	
<b>*B</b> * High density Bamboo	* High-Density Bamboo finish only available in North America

EXAMPLE:  
MG CRNX01 MSXX =



## MIXOLOGY CART

Get a step ahead of the Mixology trend by giving your experienced bartenders the perfect mixing companion.



MG CRNX03 MSXX  
(shown with optional Charcoal-Black quick cover)



(shown with optional Charcoal-Black quick covers)

The original Roll'n Service Cart customized with a border, leather towel hanger, wood cutting board, wine glass holders, and an ice bucket.

MG CRNX03 MSXX

High-Density Bamboo finish only available in North America

## DAY & NIGHT

Roll'n Service Carts can serve guests tea at breakfast, or entertain with a wine cart at an evening event.



**TOP BORDER CART** MG CRNX02 WBXX  
(shown with optional Golden-Brown quick covers)

**MIXOLOGY CART** MG CRNX03 MSXX  
(shown with optional Jungle-Green quick covers)





**TOP BORDER CART** MG CRNX02 MSXX  
(shown with optional Charcoal-Black quick covers and ice/champagne bucket)













## SYSTEM BREAKDOWN

Roll'n System Breakdown consists of BHP panels in three different finishes or high-density bamboo panels, leg segments available in two finishes, as well as an ever-expanding collection of functional accessories.

This wide selection gives you the freedom to design your own cart depending on your specific needs or transform your existing basic cart into a Cheese and Wine Cart or a Mixology Cart.

## MOGOGO TOOLS

	1 piece	<b>ALLEN KEY FOR M16</b>	MG SAUXSS 0101
	1 piece	<b>M16 SCREWS</b>	MG SSCWMT 0101
 	1 piece	<b>BLACK SCREW CAP</b>	MG SSACPL 0601
 	1 piece	<b>GREY SCREW CAP</b>	MG SSACPL 0501
 	1 piece	<b>BROWN SCREW CAP</b>	MG SSACPI 0201
 X1  X2  X12		<b>UTILITY KIT: ALLEN KEY FOR M16 2 M16 SCREWS 12 SCREW CAPS (4 Screw caps X 3 colors)</b>	MG SSACSM 0102



## MATERIAL GUIDE

Customize your Roll'n Service Carts by choosing from the different colors and finishes available. Simply choose your preferred design combination by inserting the corresponding letter to its designated space as demonstrated below.

Item code: MG C#####

Design combination: TOP SEGMENT XX

TOP: M, S, G, B, W, \*B

SEGMENT: S, B

M: Nero Marquina Marble BHP

S: Brushed Stainless Steel

G: Grey Slate BHP

B: Brushed Brass

W: Bengali Mango Wood BHP

\*B: \* High-Density Bamboo finish only available in North America

EXAMPLE:  
MG CRNX01 MSXX =



## SERVICE CART



**SERVICE CART**  
L41.5" W21" H36"  
L105cm W53cm H91cm

MG CRNX01 \_\_ XX

## QUICK COVERS

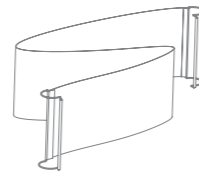

**SERVICE CART QUICK COVERS**  
2 per box

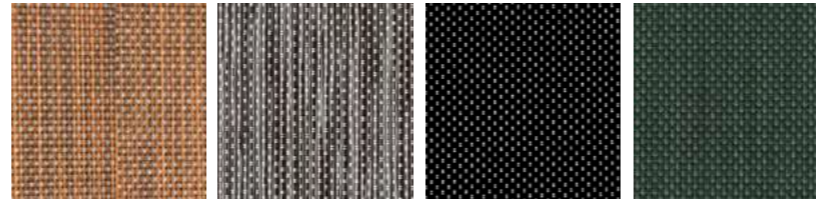

Golden-Brown Silver-Grey Charcoal-Black Jungle-Green

MG SQCOPV 1301 MG SQCOPV 1401 MG SQCOPV 2101 MG SQCOGP 0701



**SERVICE CART STORAGE COVERS**  
2 per box

MG SQCOPV 2902 MG SQCOPV 3602 MG SQCOPV 3702 MG SQCOGP 1202

## ADD-ONS

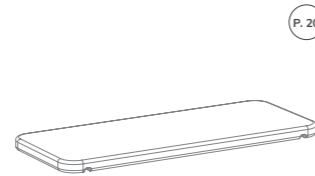

**CUTTING BOARD**  
L19" W8" H0.7"  
L49cm W20cm H2cm  
fits Border

MG SSCMBM 0201

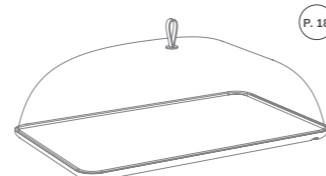

**CHEESE TRAY**  
L19" W12" H7"  
L49cm W30cm H17cm  
fits Border

MG SSCMBM 0501

## ADD-ONS

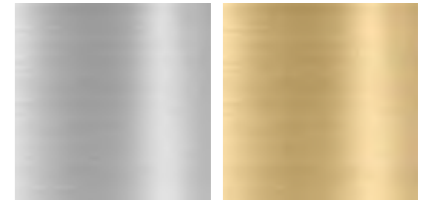

Brushed Stainless Steel Brushed Brass

MG SSCMSS 0401 MG SSCMBR 0101

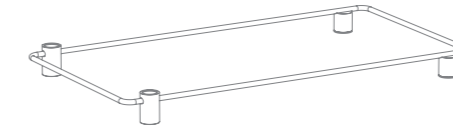

**BORDER**  
L31.5" W17" H2"  
L80cm W44cm H5cm  
fits service cart



**LEATHER TOWEL HANGER**  
fits Border

MG SSCMSL 0101 MG SSCMSL 0201



**WINE GLASS HOLDER**  
L21" W4" H2"  
L53cm W11cm H5.5cm  
Holds up to 6 wine glasses

MG SSCMSS 0501 -/-



**ICE / CHAMPAGNE BUCKET**  
Ø6" H6"  
Ø15.5cm H15.5cm  
fits Border

MG SSCMSS 0601 -/-

mogogo  
BUFFET SOLUTIONS



POLO  
TABLES

2022/2023

DISTRIBUTED BY:  **steelite**  
INTERNATIONAL





**SQUARE BISTRO TABLE** MG CPRS01 WSXX \ \ **ROUND BISTRO TABLE** MG CPRR01 MSXX

INDEX



A PROFESSIONAL  
FOOD & BEVERAGE  
FURNITURE COMPANY

BORN FROM AN INTERDISCIPLINARY  
PASSION FOR **Design x Food**



Mogogo is led by designers and chefs that are driven by the desire to introduce new, beautiful, and functional products to the market, with an environmentally friendly philosophy in mind.

WE PUSH  
THE CREATIVE ENVELOPE  
OF FUNCTION AND INNOVATION.



LINENLESS



MODULAR



MOBILE



SUSTAINABLE



ADD ONS







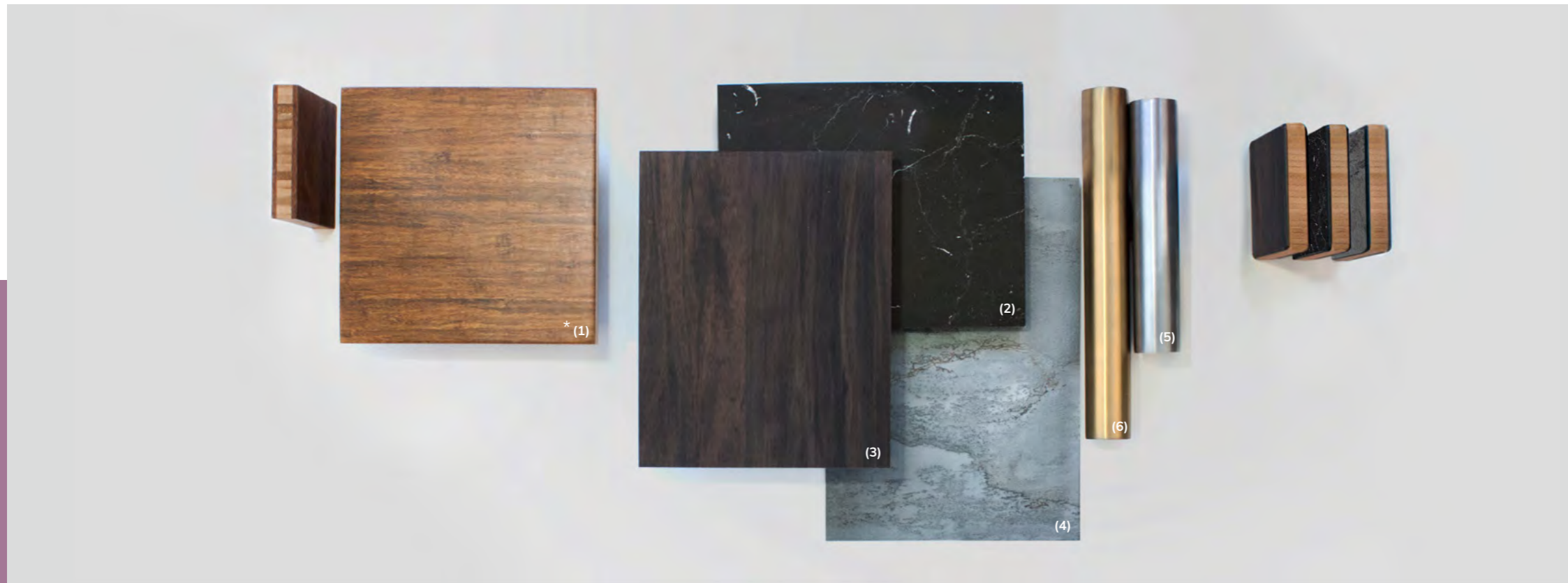

## ABOUT POLO COLLECTION

Mogogo's PoLo Tables are lightweight and extremely versatile, designed using our unique Modular System.

Available in Round, Square, or Oval Tabletop shapes, they offer a wide variety of combinations.

This approach allows for the same coffee table to be effortlessly transformed into a bistro or bar table and then into a champagne or dessert station in no time. It provides you with flexibility while also retaining simplicity and style.

## MATERIALS

Joining our Bamboo **(1)\*** collection is our new innovative BHP material. BHP is a newly composed material that arrived after two years of intense R&D. It merges layers of High-Pressure Laminate with a Vertical Bamboo core (Mogogo's expertise) creating a lighter yet durable panel that offers new textures and colors. This new material combines the advantages of both bamboo and HPL, perfect for the ever-changing needs of the hospitality industry. Available in a variety of finishes that resemble natural materials such as Nero Marquina Marble, Bengali Mango Wood, and Grey Slate, **(2-4)**, making it easy to match with any event and decor.

The innovative bamboo core of the BHP goes in line with Mogogo's sustainability motto while the HPL's outer coating is durable for different environments, hygienic, and easy to clean.

PoLo segments come in 2 finishes: brushed stainless steel **(5)** and brushed brass **(6)**.

\* High-Density Bamboo finish only available in North America



## HOW IT WORKS

Mogogo's PoLo Tables' industrial design is based on the Modular System. Delivered to you in flat packaging, it is easy and fast to assemble and disassemble. Composed of the same individual components (tabletops, leg segments, and mid-part segments) it gives you the flexibility to transform the same coffee table into a bistro table, a bar table, or a display table.

PoLo's cross base and adjustable legs give it stability and the flexibility to adapt your table to any terrain. The clean one pole design makes this table blend easily into any design scheme and event space.

Highly versatile while offering durability and functionality, PoLo Tables enable you to use your creativity. Play with heights, tabletop shapes (round, square, or oval), different finishes, and add shelving layers as needed for additional display.

FLAT PACK PACKAGING

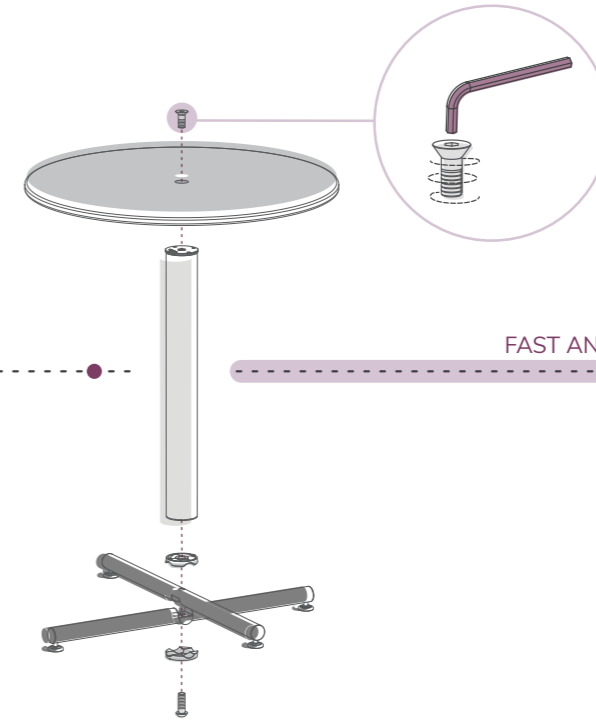
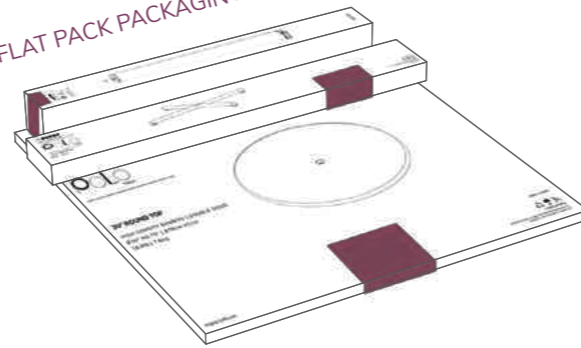

FAST AND EASY ASSEMBLY

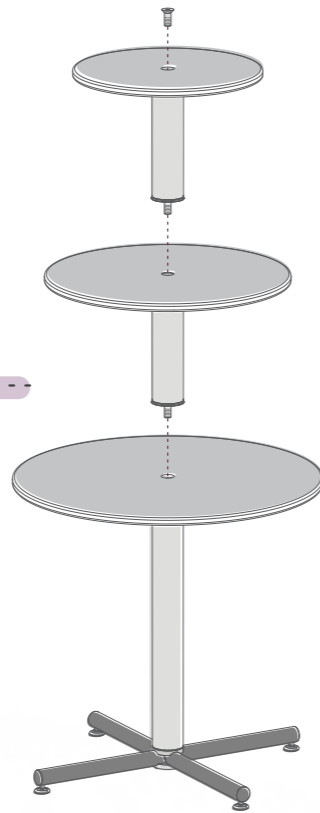

ROUND DISPLAY TABLE

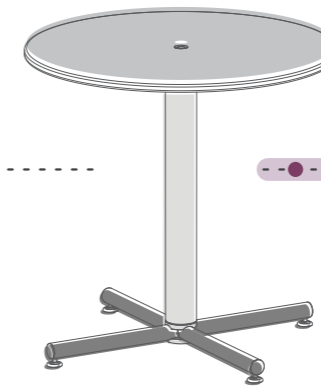

ROUND BISTRO TABLE

POLO TABLES  
COFFEE / DISPLAY / BISTRO

MIX AND MATCH



ADAPTS TO ANY OCCASION.



MG CPPS01 WBXX



MG CPRR01 MBXX



# COLOR COMBINATIONS



MG CPBR01GBXX

Different colors, shapes, and heights make the PoLo table perfect for multiple combinations and styles. Completely transform the atmosphere of your event by changing the tables' heights. From bar to bistro to coffee tables, try a combination to maximize space.



MG CPFV01 MSXX



\*  
Mix Nero Marquina Marble finish with brass for an elegant, classy look, while Grey Slate with stainless gives it an urban and outdoor feel.



MG CPBS02 WSXX







**OVAL COFFEE TABLE** MG CPFV01 WSXX



## COFFEE TABLES

In addition to being lightweight, quickly assembled, and versatile while offering durability, Mogogo Coffee Tables can be placed anywhere in the room, for both decorative and service purposes.

Combined with other available heights and tabletop shape options, you can create interesting visual variations in elevations to further add to your stylish display.

## MATERIAL GUIDE

Customize your PoLo Tables by choosing from the different colors and finishes available. Simply choose your preferred design combination by inserting the corresponding letter to its designated space as demonstrated below.

Item code: MG C#####

Design combination: TOP SEGMENT XX

TOP:  TOP

SEGMENT:  SEGMENT

**M**  
Nero Marquina Marble BHP

**S**  
Brushed Stainless Steel

**G**  
Grey Slate BHP

**B**  
Brushed Brass

**W**  
Bengali Mango Wood BHP

**\*B**  
\* High-Density Bamboo finish only available in North America  
\* High density Bamboo

EXAMPLE:

MG CPBR01 MSXX =



### ROUND COFFEE TABLE

Beautiful round coffee table for any small and intimate setup.

MG CPFR01 BSXX

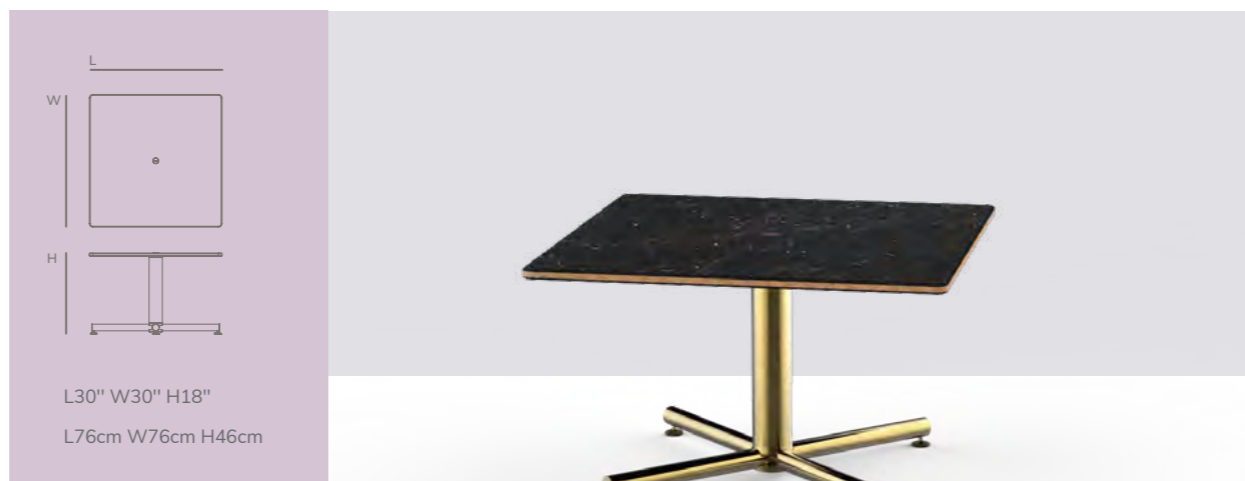

### SQUARE COFFEE TABLE

An elegant and stylish squared coffee table that will fit perfectly in any setup.

MG CPFS01 MBXX



### OVAL COFFEE TABLE

Ideal oval shaped top that is bigger in size, making it perfect for a lounge or food display.

MG CPFV01 GSXX





**SQUARE BISTRO TABLE** MG CPRS01 WBXX



## **BISTRO TABLES**

The 30" (76 cm) table is the most common height and diameter utilized for dining tables in the hospitality industry. Available in both round and square tabletop shapes, the Mogogo PoLo Tables unique modular system allows to be transformed into a highboy or three-tier dessert station in just a few steps.

Mogogo Bistro Tables are designed for a lightweight, stylish, and clean look, in addition to their flexible and functional properties.

## MATERIAL GUIDE

Customize your PoLo Tables by choosing from the different colors and finishes available. Simply choose your preferred design combination by inserting the corresponding letter to its designated space as demonstrated below.

Item code	Design combination		
MG C#####	TOP	SEGMENT	XX
			
	<b>M</b>	<b>S</b>	
	Nero Marquina Marble BHP	Brushed Stainless Steel	
	<b>G</b>	<b>B</b>	
	Grey Slate BHP	Brushed Brass	
	<b>W</b>		
	Bengali Mango Wood BHP		
	<b>*B</b>		
	* High density Bamboo		
	* High-Density Bamboo finish only available in North America		

EXAMPLE:  
MG CPBR01 MSXX =



### ROUND BISTRO TABLE

Ultimate round top dining table for any hospitality setting, with perfect height making it accessible.

MG CPRR01 GSXX



### SQUARE BISTRO TABLE

Square dining table, the perfect size that fits any venue or display.

MG CPRS01 WBXX

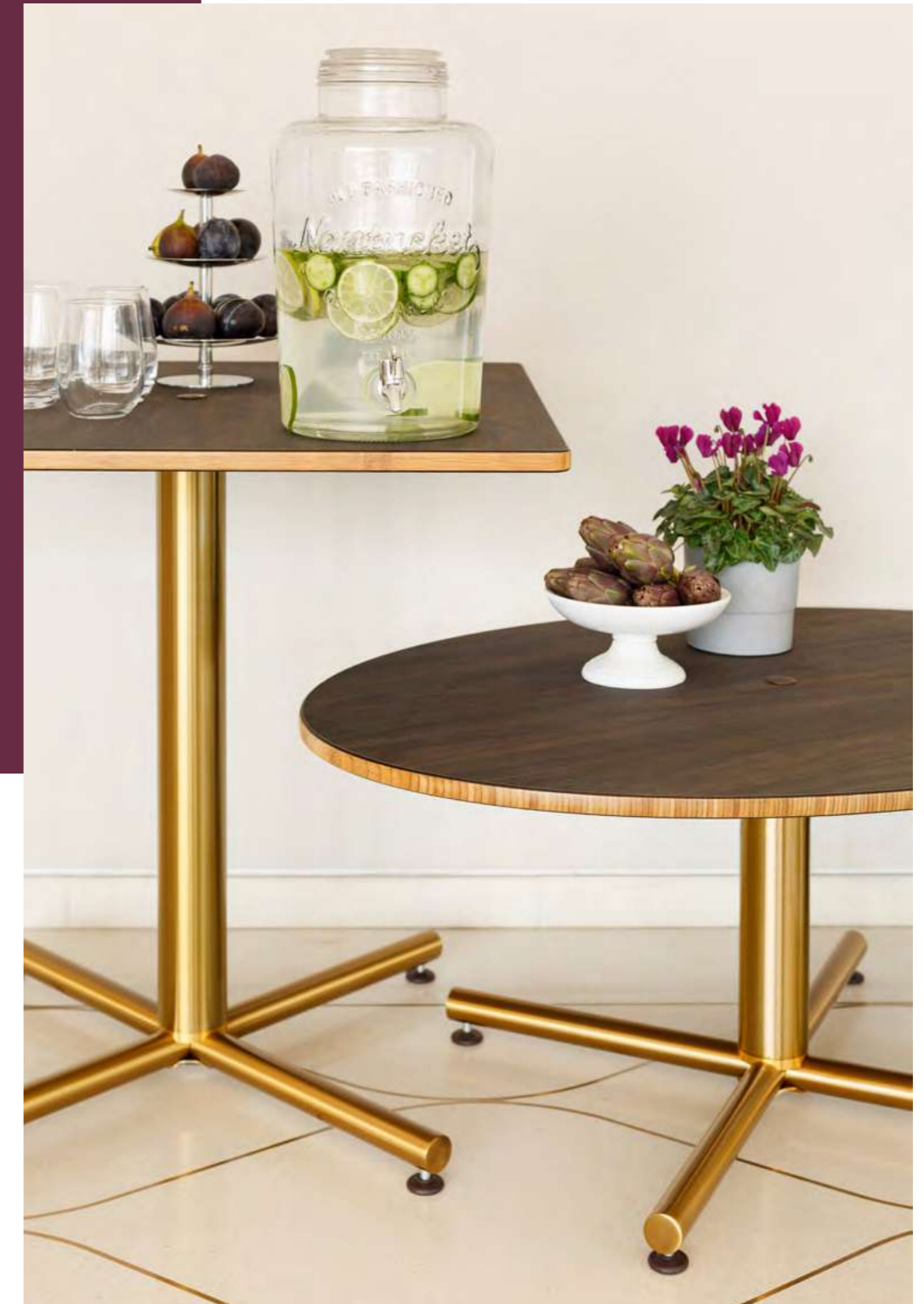

**SQUARE BISTRO TABLE** MG CPRS01 WBXX || **OVAL COFFEE TABLE** MG CPFV01 WBXX

High-Density Bamboo finish only available in North America



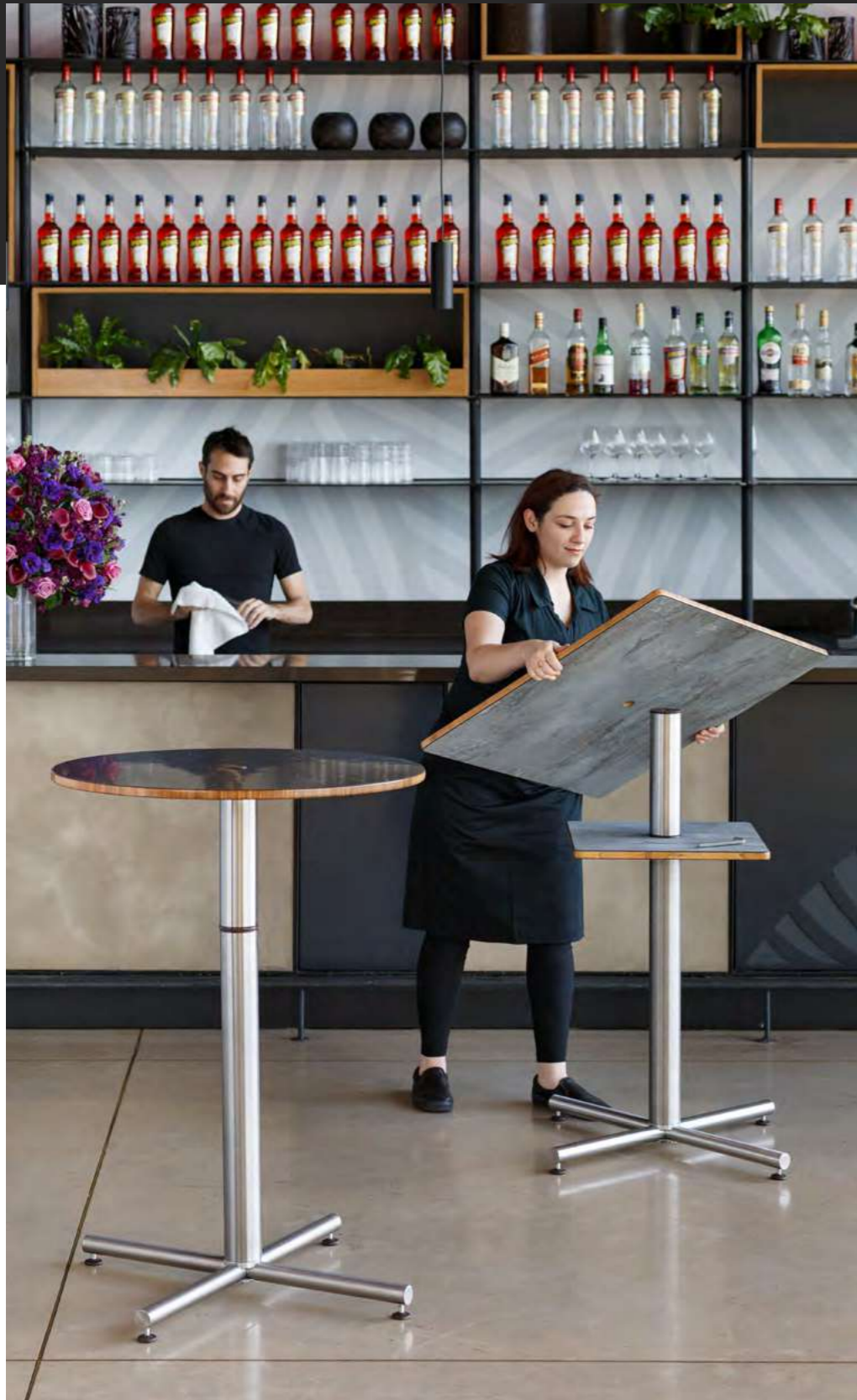

**ROUND BAR TABLE** MG CPBR01 MSXX \ \ **SQUARE BAR TABLE + SHELF** MG CPBS02 GSXX

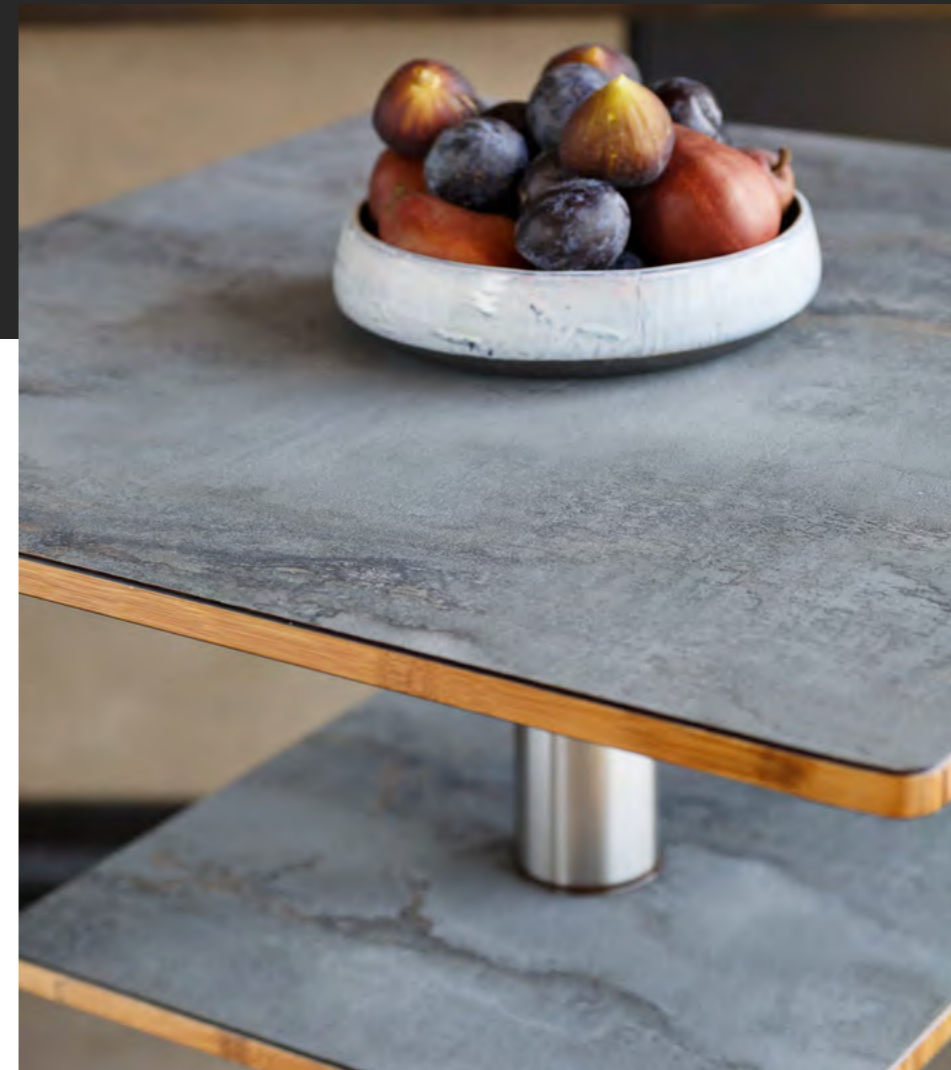

## BAR TABLES

Mogogo Bar Tables consist of Round or Square Tabletops and elongated bases made of brushed stainless steel or brushed brass finish.

In addition to being sleek and eye-catching from anywhere in the room, these tables are highly sturdy and can be used in a number of ways. Additionally, can be placed near different height round or square tables for a unique take on serving drinks or delicacies.

## MATERIAL GUIDE

Customize your PoLo Tables by choosing from the different colors and finishes available. Simply choose your preferred design combination by inserting the corresponding letter to its designated space as demonstrated below.

Item code: MG C#####  
 Design combination: TOP SEGMENT XX



TOP



SEGMENT



M  
Nero Marquina  
Marble BHP

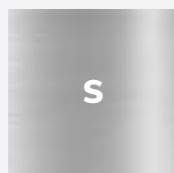

S  
Brushed Stainless  
Steel



G  
Grey Slate BHP

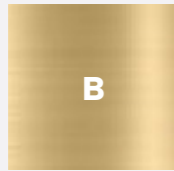

B  
Brushed Brass



W  
Bengali Mango  
Wood BHP

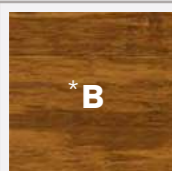

\* B  
\* High density  
Bamboo

\* High-Density  
Bamboo finish  
only available in  
North America

EXAMPLE:

MG CPBR01 MSXX =



Ø30" H42"  
Ø76cm H106cm

### ROUND BAR TABLE

Easily portable round top that completes any fancy cocktail party.

MG CPBR01 WSXX



L30" W30" H42"  
L76cm W76cm H106cm

### SQUARE BAR TABLE

Square bar table that looks fantastic in every social gathering.

MG CPBS01 GSXX



Ø30" H42.5"  
Ø76cm H108cm

### ROUND BAR TABLE + SHELF

Perfect round bar table with added lower shelf for modularity and style.

MG CPBR02 MBXX



L30" W30" H42.5"  
L76cm W76cm H108cm

### SQUARE BAR TABLE + SHELF

Refined Square bar table with a shelf that is great to expose food or beverage in a unique way.

MG CPBS02 BBXX



## DAY & NIGHT

PoLo Tables fit in your morning coffee lounge just as well as they do in elegant evening events.



ROUND COFFEE TABLE MG CPFR01 GSXX



ROUND DISPLAY TABLE MG CPPR01 WBXX



**ROUND DISPLAY TABLE** MG CPPR01 MBXX



## DISPLAY TABLES

Celebrate in style with these elegant Round or Square Top Display Tables.

Create an artistic design to help enrich and elevate the way you serve. Choose this table in order to show off a divine selection of hors-d'oeuvres, wine, mixed drinks, or any type of finger food.

With an elevated base and impressive decoration, Mogogo Display Tables are visible from anywhere in the room and can serve desserts, champagne, or anything else you would like to bring to the attention of your guests.



## MATERIAL GUIDE

Customize your PoLo Tables by choosing from the different colors and finishes available. Simply choose your preferred design combination by inserting the corresponding letter to its designated space as demonstrated below.

Item code: MG C#####  
 Design combination: TOP SEGMENT XX

TOP: M, G, W, \*B  
 SEGMENT: S, B

M: Nero Marquina Marble BHP  
 G: Grey Slate BHP  
 W: Bengali Mango Wood BHP  
 \*B: \* High-Density Bamboo finish only available in North America

S: Brushed Stainless Steel  
 B: Brushed Brass

EXAMPLE:  
 MG CPBR01 MSXX =



### ROUND DISPLAY TABLE

Graceful round display table with two shelves that adds a special touch to all your food and beverages.

MG CPPR01 MBXX



### SQUARE DISPLAY TABLE

Classic yet fashionable square display table with two shelves that complete any display beautifully.

MG CPPS01 GSXX



SQUARE DISPLAY TABLE MG CPPS01 GSXX

## TRANSFER & STORAGE CARTS

Mogogo's utility carts are designed for your convenience and mobility and are an integral part of the PoLo system as they make storing and assembling the tables easy. Whether it is to pull out the tabletops, to push them through the halls, or get in and out of elevators; they make the behind the scenes of your time-sensitive events easier and give you an extra push on productivity.



**SEGMENTS AND ADD-ONS  
TRANSFER AND STORAGE CART**  
L55.5" W31" H50"  
L141cm W79cm H127.5cm  
holds segments and cross bases for 15 PoLo tables

MG CUUX01 XXXX

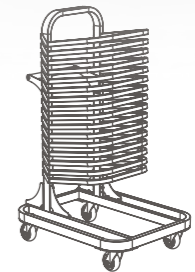

**ROUND / SQUARE TOP  
TRANSFER AND STORAGE CART**  
L40" W31" H61"  
L101cm W79cm H155cm  
holds up to 16 PoLo round/square tops

MG CUUX04 XXXX

## UTILITY CART ADD-ON



**ROUND / SQUARE TOP CART ADD-ON  
SMALL SHELF STORAGE**  
L37" W17.5" H3"  
L94cm W44cm H7.5cm  
Holds a minimum of 16 PoLo round/square shelves  
MG SADDPS 0201















## SYSTEM BREAKDOWN

Mogogo's PoLo Table Collection is composed of three different shapes of tabletops: round, square and oval. Different sizes of leg segments are available in two finishes and optional smaller shelves in corresponding shapes.

Three types of parts; endless possibilities and table functions.

## MOGOGO TOOLS

	1 piece	<b>ALLEN KEY FOR M16</b>	MG SAUXSS 0101
	1 piece	<b>M16 SCREWS</b>	MG SSCWMT 0101
 	1 piece	<b>BLACK SCREW CAP</b>	MG SSACPL 0601
 	1 piece	<b>GREY SCREW CAP</b>	MG SSACPL 0501
 	1 piece	<b>BROWN SCREW CAP</b>	MG SSACPI 0201
 X1  X2  X12		<b>UTILITY KIT: ALLEN KEY FOR M16 2 M16 SCREWS 12 SCREW CAPS (4 Screw caps X 3 colors)</b>	MG SSACSM 0102

## LEGS

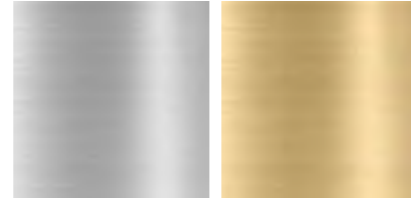

Brushed Stainless Steel    Brushed Brass

MG SPOLSS 0301    MG SPOLBR 0301

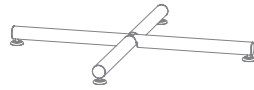

**CROSS BASE**  
30" | 76cm



**12" SEGMENT**  
H12" | H30cm

MG SLEGSS 0101    MG SLEGBR 0301



**15" SEGMENT**  
H15" | H38cm

MG SPOLSS 0101    MG SPOLBR 0101



**26" SEGMENT**  
H26" | H67cm

MG SPOLSS 0201    MG SPOLBR 0201

## TOPS

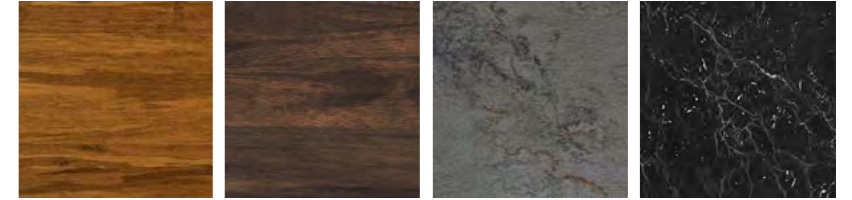

\* High density Bamboo    Bengali Mango Wood BHP    Grey Slate BHP    Nero Marquina Marble BHP



**30" ROUND TOP**  
Ø30" | Ø76cm

MG SCRTBM 0102    MG SCRTHW 0101    MG SCRTHG 0101    MG SCRTHB 0101



**24" ROUND TOP**  
Ø24" | Ø60cm

MG SCRTBM 0202    MG SCRTHW 0201    MG SCRTHG 0201    MG SCRTHB 0201



**18" ROUND TOP**  
Ø18" | Ø46cm

MG SCRTBM 0302    MG SCRTHW 0301    MG SCRTHG 0301    MG SCRTHB 0301

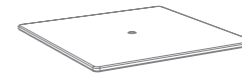

**30" SQUARE TOP**  
30" | 76cm

MG SPOLBM 0401    MG SPOLHW 0401    MG SPOLHG 0401    MG SPOLHB 0401

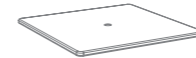

**24" SQUARE TOP**  
24" | 60cm

MG SPOLBM 0301    MG SPOLHW 0301    MG SPOLHG 0301    MG SPOLHB 0301

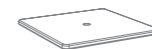

**18" SQUARE TOP**  
18" | 46cm

MG SPOLBM 0201    MG SPOLHW 0201    MG SPOLHG 0201    MG SPOLHB 0201



**42.5" OVAL TOP**  
L42.5" W30" | L108cm W76cm

MG SPOLBM 0101    MG SPOLHW 0101    MG SPOLHG 0101    MG SPOLHB 0101



mogogo  
BUFFET SOLUTIONS



DiX  
TABLES

2022/2023

DISTRIBUTED BY:  **steelite**  
INTERNATIONAL



**H30" ROUND TABLE** MG CCVR01 WBXX \ \ MG CCVR01 GBXX

INDEX





A PROFESSIONAL  
FOOD & BEVERAGE  
FURNITURE COMPANY

# BORN FROM AN INTERDISCIPLINARY PASSION FOR **Design x Food**



Mogogo is led by designers and chefs that are driven by the desire to introduce new, beautiful, and functional products to the market, with an environmentally friendly philosophy in mind.

WE PUSH  
THE CREATIVE ENVELOPE  
OF FUNCTION AND INNOVATION.



LINENLESS



MODULAR



MOBILE



SUSTAINABLE



ADD ONS







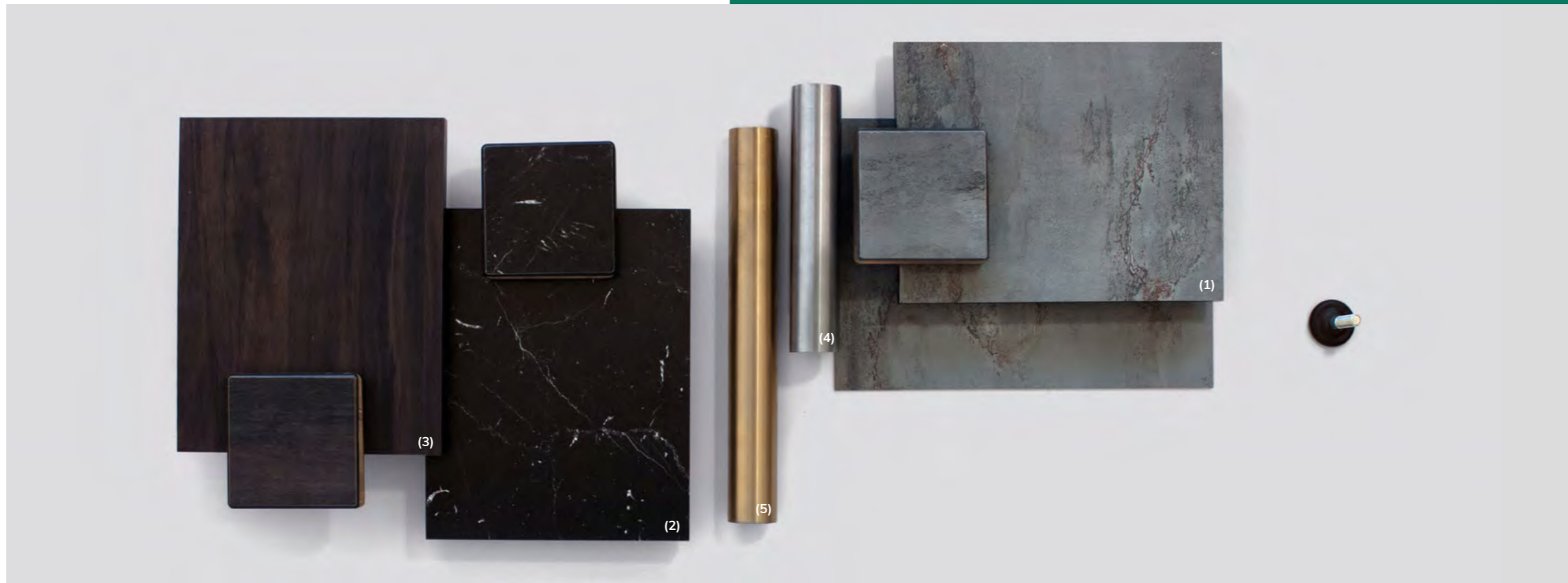

## ABOUT CLIX COLLECTION

Like everything designed by Mogogo, CliX is both functional and beautiful, all while making the lives of our customers a little bit easier. CliX is inspired by the existing strengths of Mogogo's modular buffet furniture while further exploring versatility and adaptability. From these two function-defining parameters came our patent-pending quick-lock mechanism. One click to attach and one twist to detach, CliX delivers a product that is easy to assemble and store.

Available in three different heights as well as three tabletop shapes each with three different finishes, CliX is another part of our quest to produce tools for professionals that combine maximum functionality with a refined design aesthetic.

CliX Tables redefine aesthetic and functional standards in the realm of F&B catering.

## MATERIALS

CliX tops are made of our innovative BHP material. BHP is a newly composed material that arrived after two years of intense R&D. It merges layers of High-Pressure Laminate with a Vertical Bamboo core (Mogogo's expertise) creating a lighter yet durable panel that offers new textures and colors. This new material combines the advantages of both bamboo and HPL, perfect for the ever-changing needs of the hospitality industry. Available in a variety of finishes that resemble natural materials such as Grey Slate, Nero Marquina Marble, and Bengali Mango Wood **(1-3)**, CliX makes it easy to match with any event and decor.

The innovative bamboo core of the BHP goes in line with Mogogo's sustainability motto while the HPL's outer coating is durable for different environments, hygienic, and easy to clean.

CliX bases come in 2 modern chic finishes- brushed stainless steel **(4)** and brushed brass **(5)**.

## HOW IT WORKS

Our unique patent-pending quick-lock mechanism and universal base, for the CliX Tables collection, makes it easy to store, assemble, and disassemble: one click to attach and one twist to detach. With a multiplicity of tabletop/base combinations to choose from, CliX Tables provide you with an unprecedented array of display options. CliX Collection offers a variability of tabletop shapes and materials, as well as different base heights and finishes giving you the freedom to create an interesting visual landscape.

CliX Tables are an elegant design solution for any F&B operation. When you combine form and function, it just CliX.

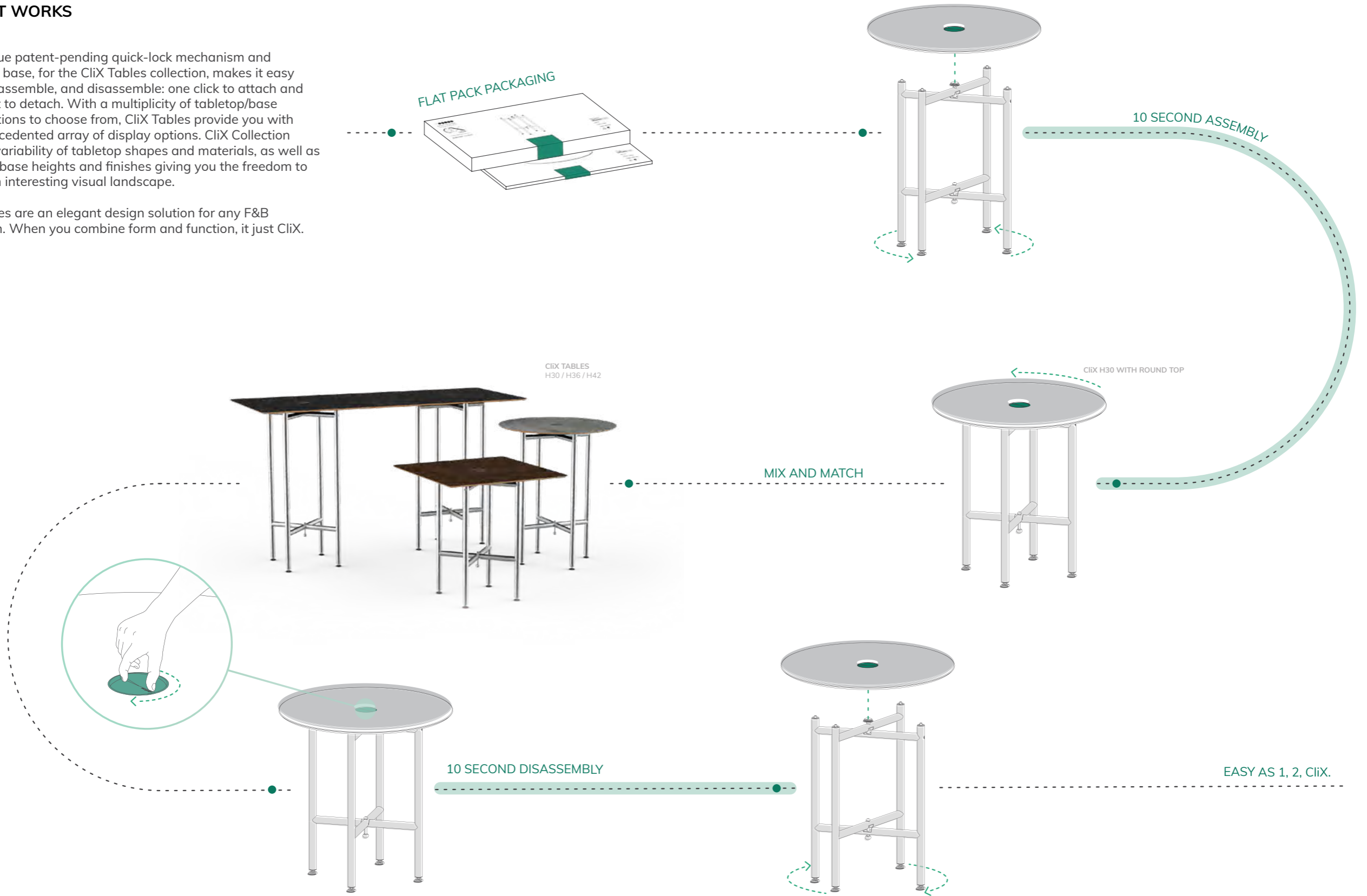





MG CCVS01 MSXX (shown with optional bottom shelf)



MG CCYG01 GSXX



# COLOR COMBINATIONS

CliX's versatility allows for multiple color combinations, perfect for creating different vibes that are easily adaptable in multiple environments.



MG CCZG01 MBXX (shown with optional bottom shelves)

\*  
Mix Nero Marquina Marble finish with brass for an elegant, classy look, while Grey Slate with stainless gives it a more modern and sleek feel.



MG CCVR01 GBXX (shown with optional bottom shelf)



MG CCVG01 WBXX (shown with optional bottom shelves)

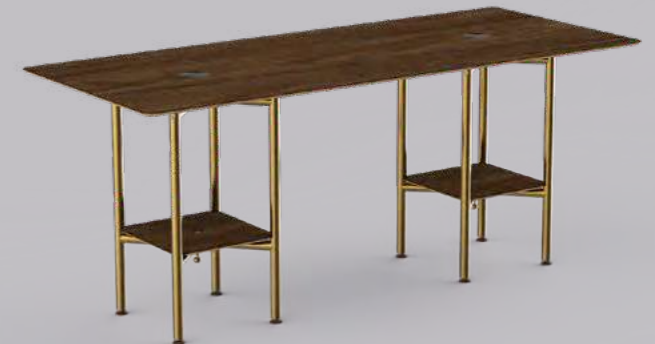





**H30" RECTANGLE TABLE** MG CCVG01 WBXX \ \ **H42" SQUARE TABLE** MG CCZS01 WBXX  
 (shown with optional Square BHP bottom shelves in a Bengali Mango Wood finish)



**H30" SQUARE TABLE** MG CCVS01 MSXX

### H30" TABLES

CliX H30 embodies the most popular height for Catering Tables.

Standard in height, but not in design: CLiX H30 instantly elevates the event atmosphere to something quite sophisticated and chic.

Available in round, square, and rectangle tabletops, CliX H30 is an essential piece for any high end or laid back catering events; adding the perfect twist that clicks.



## MATERIAL GUIDE

Customize your CliX Tables by choosing from the different colors and finishes available.

Simply choose your preferred design combination by inserting the corresponding letter to its designated space as demonstrated below.

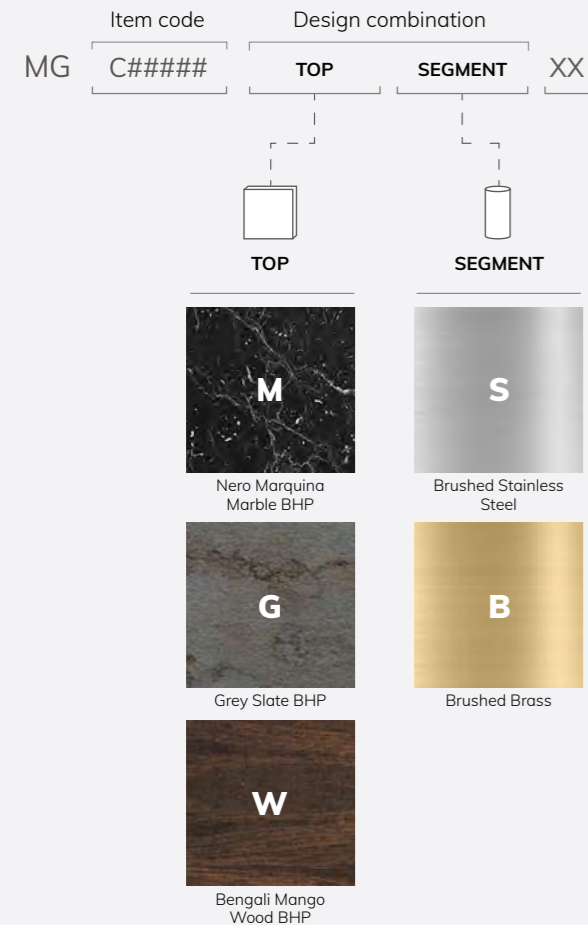

EXAMPLE:

MG CCVR01 WBXX =



### H30" ROUND TABLE

CliX H30" | 76cm Base with a Round BHP top.  
 Food displays will be at a whole other level with the CliX catering tables.

MG CCVR01 GBXX



### H30" SQUARE TABLE

CliX H30" | 76cm Base with a Square BHP top.  
 With these CliX tables, put together an events' buffet in just seconds.

MG CCVS01 MSXX

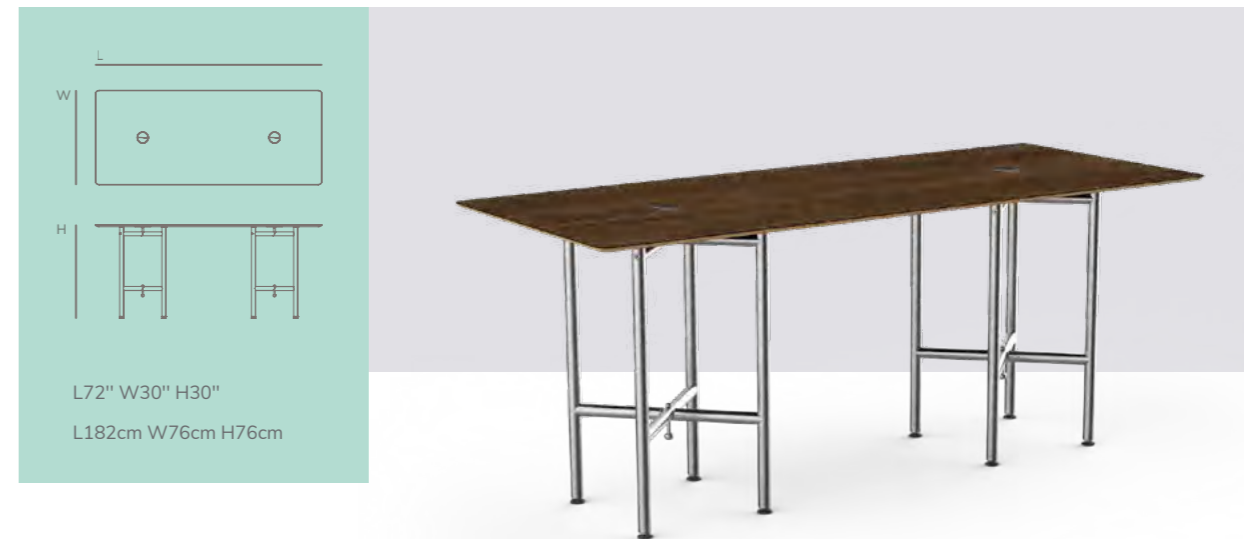

### H30" RECTANGLE TABLE

CliX H30" | 76cm Base with a Rectangle BHP top.  
 Showcase delicious food on a larger and elegant CliX Table.

MG CCVG01 WSXX



**H36" SQUARE TABLE** MG CCYS01 MSXX

(shown with optional Square BHP bottom shelf in a Nero Marquina Marble finish)

**H30" ROUND TABLE** MG CCVR01 GSXX

(shown with optional Round BHP bottom shelf in a Grey Slate finish)



**H36" RECTANGLE TABLE** MG CCYG01 WBXX

## H36" TABLES

CliX H36 serves as the perfect intermediate between a Bar and Dining Table height.

Created to add further vertical diversity, it is a great addition to its other catering companions.

Available in round, square, and rectangle tabletops, CliX H36 completes the vision of a diverse and surprising visual landscape for any event.



## MATERIAL GUIDE

Customize your CliX Tables by choosing from the different colors and finishes available.

Simply choose your preferred design combination by inserting the corresponding letter to its designated space as demonstrated below.

Item code: MG C#####  
 Design combination: TOP SEGMENT XX



TOP



SEGMENT



M  
Nero Marquina  
Marble BHP

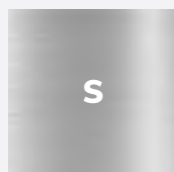

S  
Brushed Stainless  
Steel



G  
Grey Slate BHP

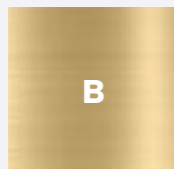

B  
Brushed Brass



W  
Bengali Mango  
Wood BHP

EXAMPLE:

MG CCVR01 WBXX =



Ø30" H36"  
 Ø76cm H91cm

### H36" ROUND TABLE

CliX H36" | 91cm Base with a Round BHP top.  
 Smoothly gather guests around CliX tables at any event.

MG CCYR01 MSXX



L30" W30" H36"  
 L76cm W76cm H91cm

### H36" SQUARE TABLE

CliX H36" | 91cm Base with a Square BHP top.  
 Easily mobile and light, the CliX are perfect for ever-changing events.

MG CCY01 WBXX



L72" W30" H36"  
 L182cm W76cm H91cm

### H36" RECTANGLE TABLE

CliX H36" | 91cm Base with a Rectangle BHP top.  
 This CliX rectangular shape allows for multiple food displays and options.

MG CCYG01 GSXX



**H42" SQUARE TABLE** MG CCZS01 WBXX  
 (shown with optional Square BHP bottom shelf in a Bengali Mango Wood finish)



**H42" RECTANGLE TABLE** MG CCZG01 GSXX \\ **H36" ROUND TABLE** MG CCYR01 GSXX  
 (shown with optional Round BHP bottom shelf in a Grey Slate finish)

## H42" TABLES

CliX H42 is a high and lightweight catering table, perfect as a High-Boy Bar Table or simply used as a Display table.

Ten seconds to assemble, ten seconds to disassemble, discover a new dimension of functionality with our patent pending mechanism.

Available in round, square, and rectangle tabletops, CliX H42 will upgrade any catering space into a high-end-design social environment.



## MATERIAL GUIDE

Customize your CliX Tables by choosing from the different colors and finishes available.

Simply choose your preferred design combination by inserting the corresponding letter to its designated space as demonstrated below.

Item code: MG C#####  
 Design combination: TOP SEGMENT XX



TOP



SEGMENT



M  
 Nero Marquina  
 Marble BHP



S  
 Brushed Stainless  
 Steel



G  
 Grey Slate BHP

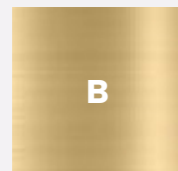

B  
 Brushed Brass



W  
 Bengali Mango  
 Wood BHP

EXAMPLE:

MG CCVR01 WBXX =



### H42" ROUND TABLE

CliX H42" | 106cm Base with a Round BHP top.  
 Scatter these CliX tables around the venue to present different finger foods and cocktails.

MG CCZR01 GSXX



### H42" SQUARE TABLE

CliX H42" | 106cm Base with a Square BHP top.  
 Quickly set the atmosphere of any event with these stunning tables.

MG CCZS01 WSXX



### H42" RECTANGLE TABLE

CliX H42" | 106cm Base with a Rectangle BHP top.  
 The ideal CliX table for larger buffet spreads and food displays.

MG CCZG01 MBXX

## DAY & NIGHT

CliX tables can help serve guests by the poolside in the morning, as well as gathering them around elegant bar tables in ballroom evening events.



**H30" RECTANGLE TABLE** MG CCVG01 WSXX



**H42" ROUND TABLE** MG CCZR01 MBXX  
(shown with optional Round BHP bottom shelf in a Nero Marquina Marble finish)



**H42" SQUARE TABLE** MG CCZS01 MBXX  
(shown with optional Square BHP bottom shelf in a Nero Marquina Marble finish)





## TRANSFER & STORAGE CARTS

Mogogo's utility carts are designed for your convenience and mobility and are an integral part of the CliX system as they make storing and assembling the tables easy. Whether it is to pull out the tabletops, to push them through the halls, or get in and out of elevators, they make the behind the scenes of your time-sensitive events easier and give you an extra push on productivity.

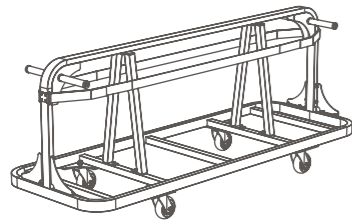

**LARGE PLATE  
TRANSFER AND STORAGE CART**  
L86.5" W31" H36.5"  
L220cm W79cm H92.5cm  
holds up to 18 CliX rectangle tops

MG CUUX03 XXXX



**LEG TRANSFER  
AND STORAGE CART**  
L55.5" W31" H50"  
L141cm W79cm H127.5cm  
holds up to 16 folded CliX legs

MG CUUX02 XXXX

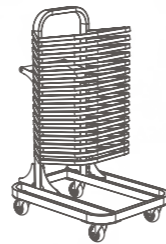

**ROUND / SQUARE TOP  
TRANSFER AND STORAGE CART**  
L40" W31" H61"  
L101cm W79cm H155cm  
holds up to 16 CliX round/square tops

MG CUUX04 XXXX

### UTILITY CART ADD-ON

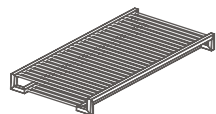

**ROUND / SQUARE TOP CART ADD-ON  
SMALL SHELF STORAGE**  
L37" W17.5" H3"  
L94cm W44cm H7.5cm  
Holds a minimum of 16 CliX round/square shelves  
MG SADDPS 0201

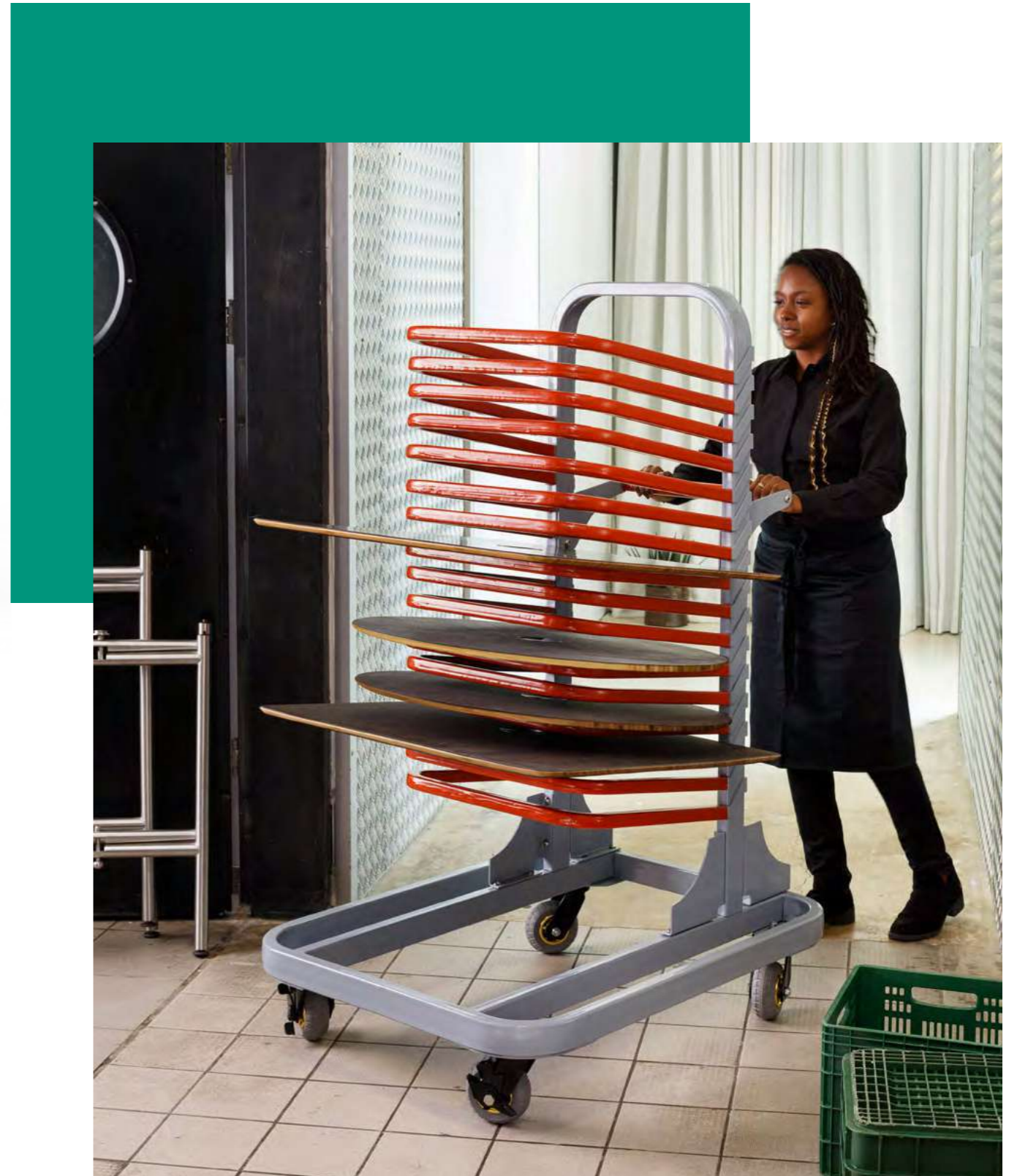

**ROUND / SQUARE TOP TRANSFER AND STORAGE CART MG CUUX04 XXXX**



## SYSTEM BREAKDOWN

Mogogo's CliX Catering Tables Collection offers endless combinations with only two basic elements at its core: Tabletop and Base.

Tabletops are available in three shapes and Three different materials. Table Bases are available in three heights and two stunning finishes. Bottom shelves are available in two shapes to add extra storage or display space.

Delivering on our promise of high functionality and diversity, the CliX Collection reveals a new paramount in product design for hospitality.



mogogo  
BUFFET SOLUTIONS



V·Shield  
SYSTEM

2022 / 2023



Back to  
Catalog  
Selection

DISTRIBUTED BY:  **steelite**  
INTERNATIONAL

## BASES

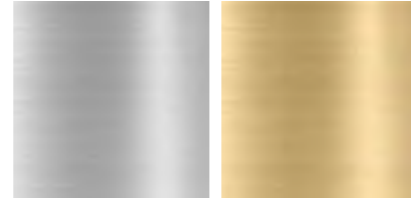

Brushed Stainless Steel

Brushed Brass

MG SCLXSS 0101

MG SCLXBR 0101

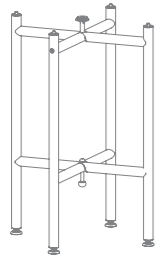

**30" BASE**  
H30" | H76cm

MG SCLXSS 0201

MG SCLXBR 0201

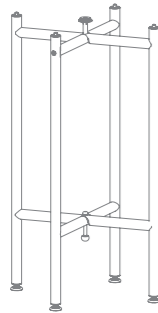

**36" BASE**  
H36" | H91cm

MG SCLXSS 0301

MG SCLXBR 0301

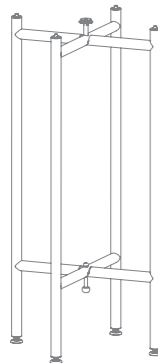

**42" BASE**  
H42" | H106cm

## TOPS



Bengali Mango Wood BHP

Grey Slate BHP

Nero Marquina Marble BHP



MG SCXTHW 0101

MG SCXTHG 0101

MG SCXTHB 0101

**RECTANGLE BHP TOP**  
L72" W30" | L182cm W76cm



MG SCXTHW 0201

MG SCXTHG 0201

MG SCXTHB 0201

**ROUND BHP TOP**  
Ø30" | Ø76cm



MG SCXTHW 0301

MG SCXTHG 0301

MG SCXTHB 0301

**SQUARE BHP TOP**  
30" | 76cm

## SHELVES



MG SCXBHW 0101

MG SCXBHG 0101

MG SCXBHB 0101

**ROUND BHP BOTTOM SHELF**  
Ø18.5" | Ø47cm

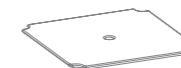

MG SCXBHW 0201

MG SCXBHG 0201

MG SCXBHB 0201

**SQUARE BHP BOTTOM SHELF**  
14" | 36cm





**DOUBLE WIDE SHIELD WITH OPENING**  
MG CDVO03 CSAS

## INDEX

- 4 About Mogogo
- 6 About The V-Shield System
- 7 Materials
- 8 How It Works
- 12 Single Shield
- 14 Multiple Shield Configurations
- 18 Unique features
- 19 V-Shield components





A MODERN  
FOODSERVICE  
FURNITURE BRAND

# BORN FROM A PASSION FOR Style & Gastronomy



Mogogo is led by designers and chefs that are aiming to introduce innovative, luxurious, and highly functional equipment to foodservice professionals.

A PERFECT BALANCE  
OF LUXURY AND FUNCTION



LINENLESS



MODULAR



MOBILE



SUSTAINABLE



ADD ONS





## ABOUT THE V-SHIELD COLLECTION

Mogogo's "Free Standing" V-Shield System was designed for safety, without sacrificing quality and aesthetics.

It can be utilized on most surfaces of any length with adaptive features to turn corners and shield the edges.

The system consists of two different size guards with the option of a full or partially full-length acrylic panel, depending on the specific application.

The V-Shield legs are equipped with magnets, alignment notches and anti-slip pads for additional stability and a clean gap-free appearance.



## MATERIALS

The V-Shield System is made of hygienic and durable materials to ensure it holds up under challenging conditions.

(1) 1/4" (6mm) thick Acrylic Panel

(2) 1/4" (6mm) thick Stainless Steel Base

(3) Tailor-made powder coated aluminum profile uprights.

## HOW IT WORKS

V-Shields are delivered flat packed and can be assembled in minutes with an Allen Key. With the wide and narrow shields, combined with the corner and end panels, creating a safe and functional configuration for your application has never been easier.

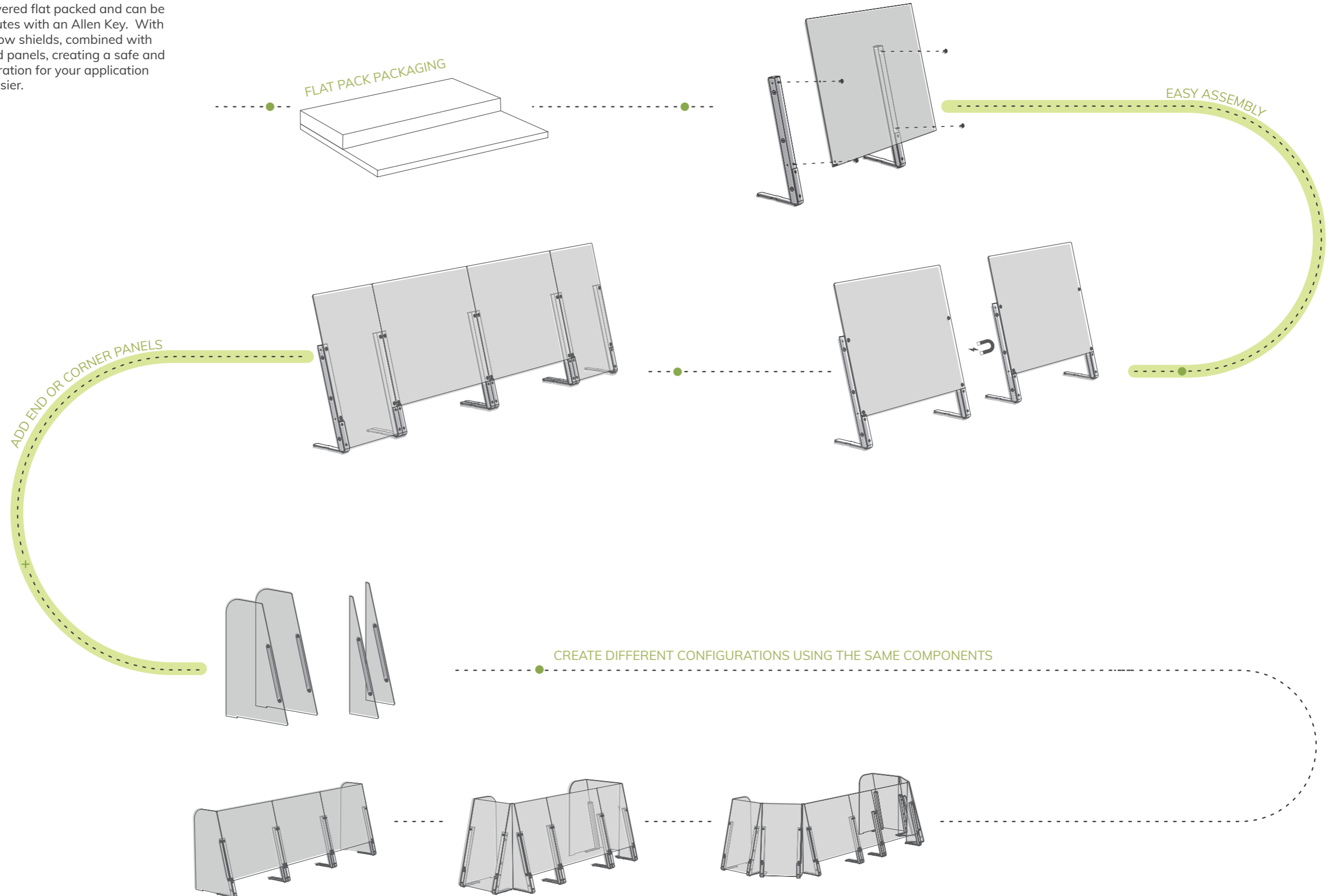





ANTI-SLIP PADS

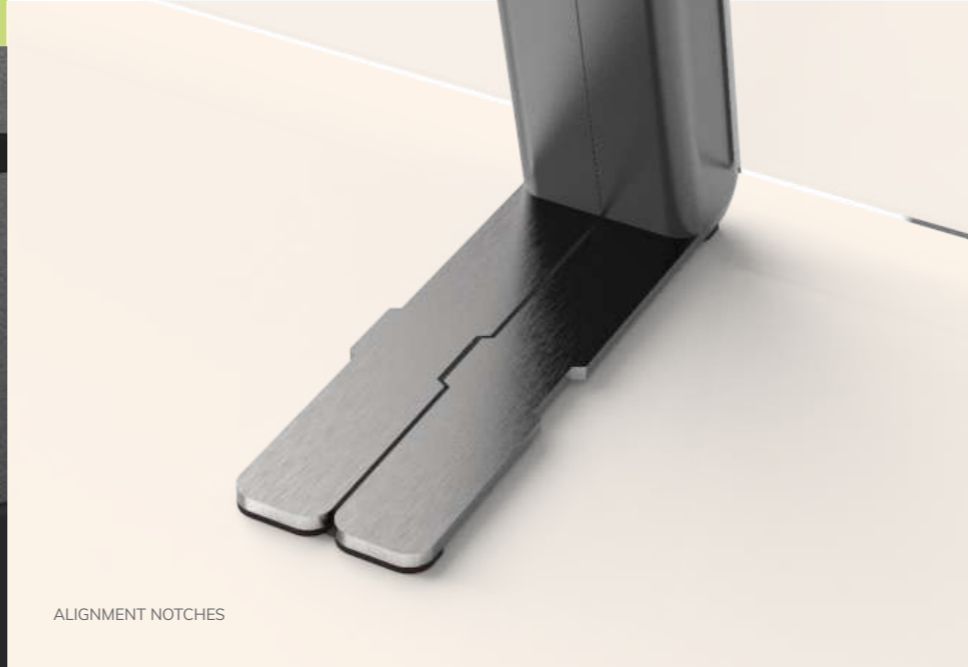

ALIGNMENT NOTCHES

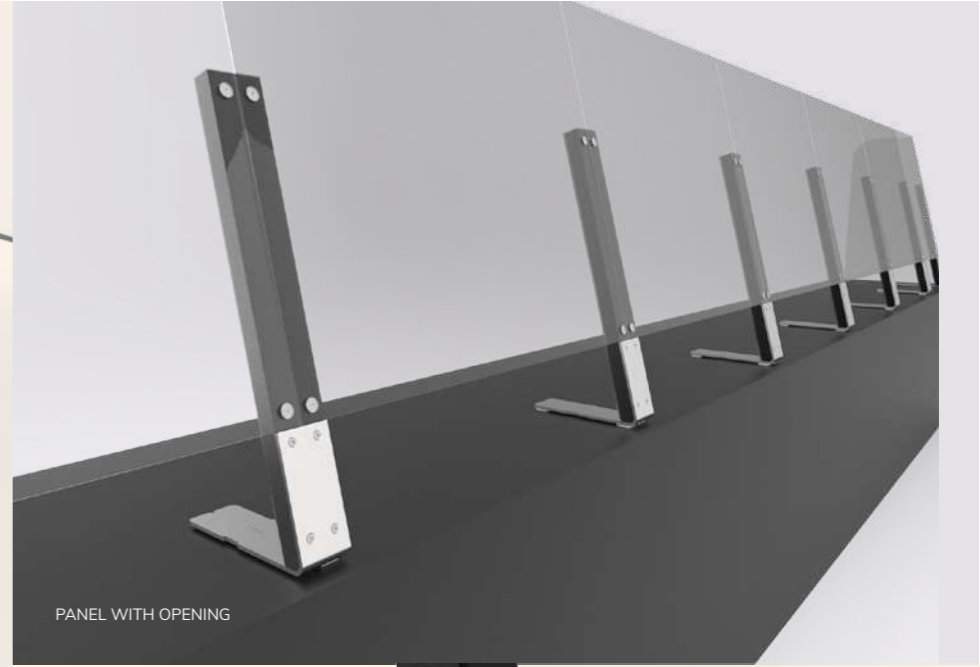

PANEL WITH OPENING

# DETAILS



CORNER PANEL



FULL PANEL



← →  
GUIDING PINS

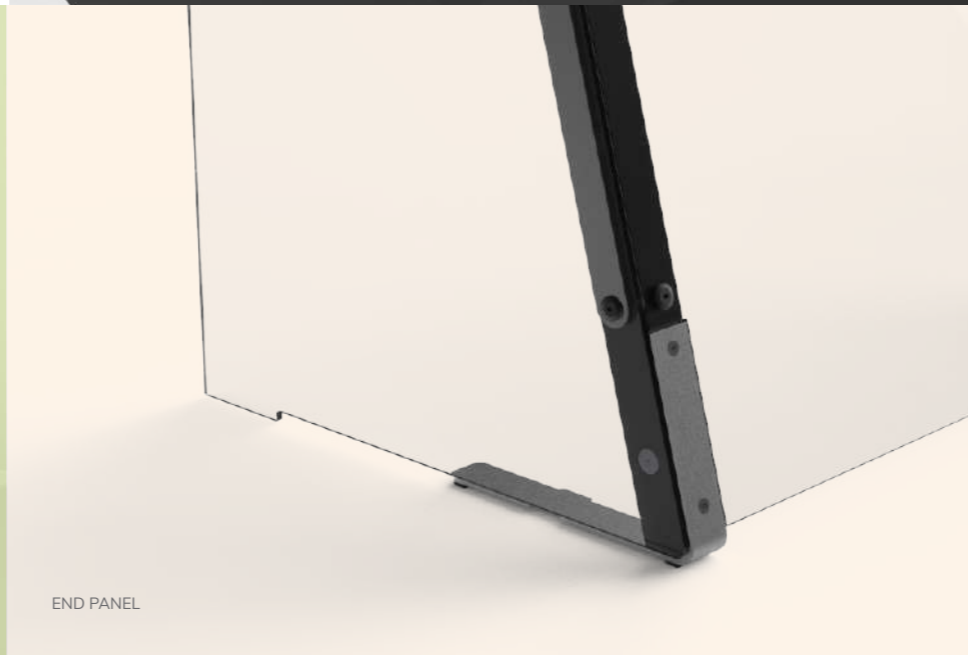

END PANEL



MAGNETS



**WIDE SHIELD**  
MGCDVO01CSAS

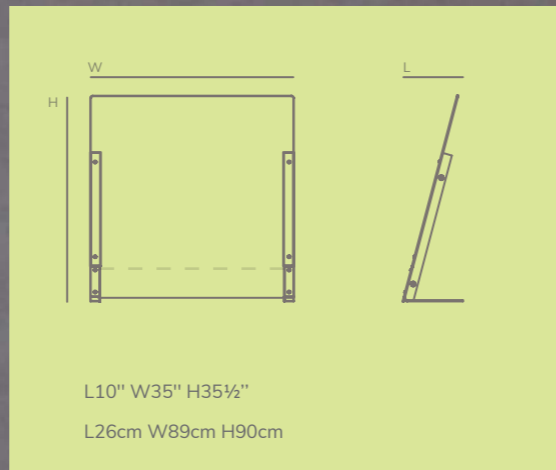

**SINGLE WIDE UNITS**



WIDE SHIELD  
W89cm H90cm | W35" H35½"  
MGCDVO01CSAC

WIDE SHIELD WITH OPENING  
W89cm H90cm | W35" H35½"  
GAP 6" 15cm  
MGCDVO01CSAS

**SINGLE NARROW UNITS**



NARROW SHIELD  
W50cm H90cm | W20" H35½"  
MGCDVO02CSAC

NARROW SHIELD WITH OPENING  
W50cm H90cm | W20" H35½"  
MGCDVO02CSAS



MULTIPLE SHIELD CONFIGARATIONS



DOUBLE WIDE SHIELD WITH OPENING  
MGCDV003CSAS



## DOUBLE CONFIGURATIONS



DOUBLE WIDE SHIELD  
W178cm H90cm | W70" H35½"  
MGCDVO03CSAC  
for 6' | 180cm TABLE

DOUBLE WIDE SHIELD WITH OPENING  
W178cm H90cm | W70" H35½"  
MGCDVO03CSAS  
for 6' | 180cm TABLE



DOUBLE WIDE SHIELD WITH OPENING AND END PANELS  
W178cm H90cm | W70" H35½"  
MGCDVO04CSAS  
for 6' | 180cm TABLE

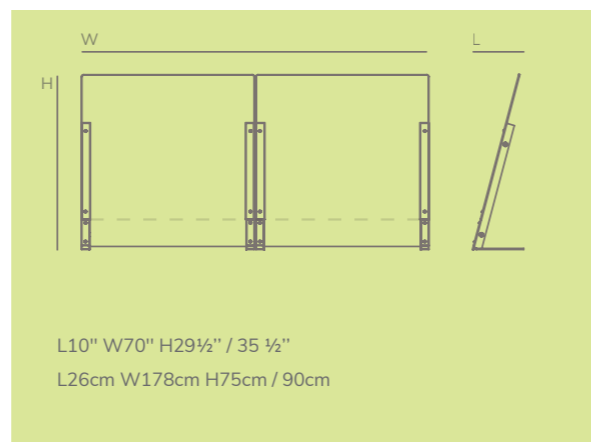

## TRIPLE CONFIGURATIONS



EXTRA WIDE SHIELD  
W228cm H90cm | W90" H35½"  
MGCDVO05CSAC  
for 8' | 244cm TABLE

EXTRA WIDE SHIELD WITH OPENING  
W228cm H90cm | W90" H35½"  
MGCDVO05CSAS  
for 8' | 244cm TABLE



EXTRA WIDE SHIELD WITH OPENING AND END PANELS  
W228cm H90cm | W90" H35½"  
MGCDVO06CSAS  
for 8' | 244cm TABLE

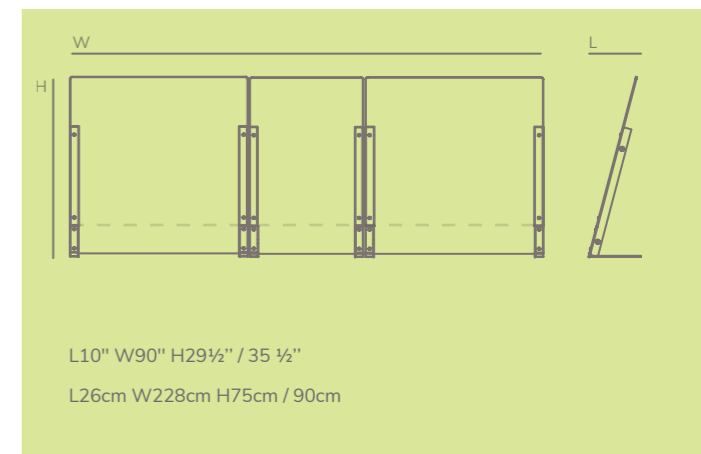



## UNIQUE FEATURES

### CORNER PANELS

The V-shield corner panels are designed to create configurations that require tight corners or a gentle radius, while maintaining a tight seal.

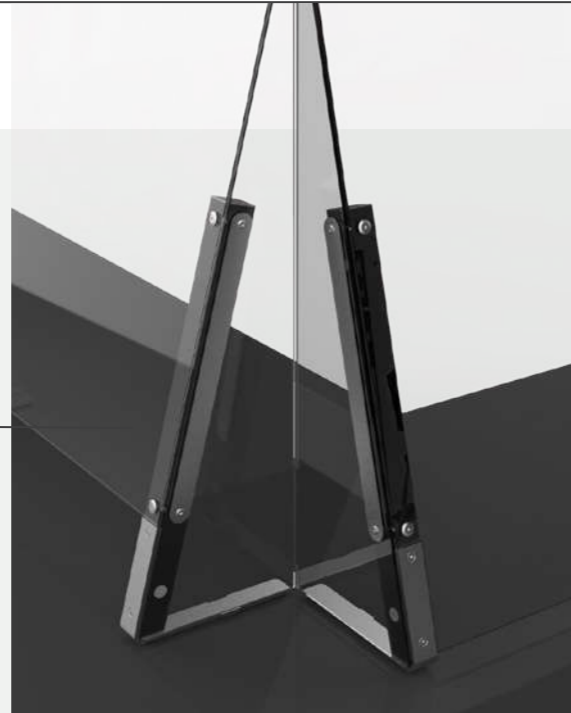

## V-SHIELD COMPONENTS

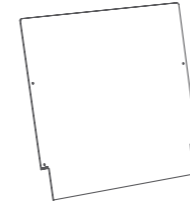

WIDE ACRYLIC PANEL  
W89cm H91cm | W35" H36"  
MGSVSDPG0101

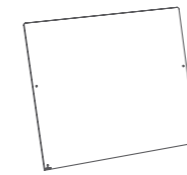

WIDE ACRYLIC PANEL WITH OPENING  
W89cm H75cm | W35" H29½"  
MGSVSDPG0201



NARROW ACRYLIC PANEL  
W50cm H91cm | W20" H36"  
MGSVSDPG0301

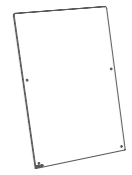

NARROW ACRYLIC PANEL WITH OPENING  
W50cm H75cm | W20" H29½"  
MGSVSDPG0401



SET OF LEGS  
MGSVSDSM0101

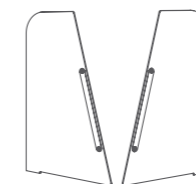

SET OF ACRYLIC END PANELS  
MGSVSDSM0301

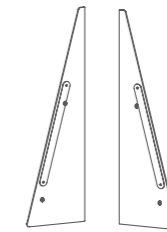

SET OF ACRYLIC CORNER PANELS  
MGSVSDSM0201

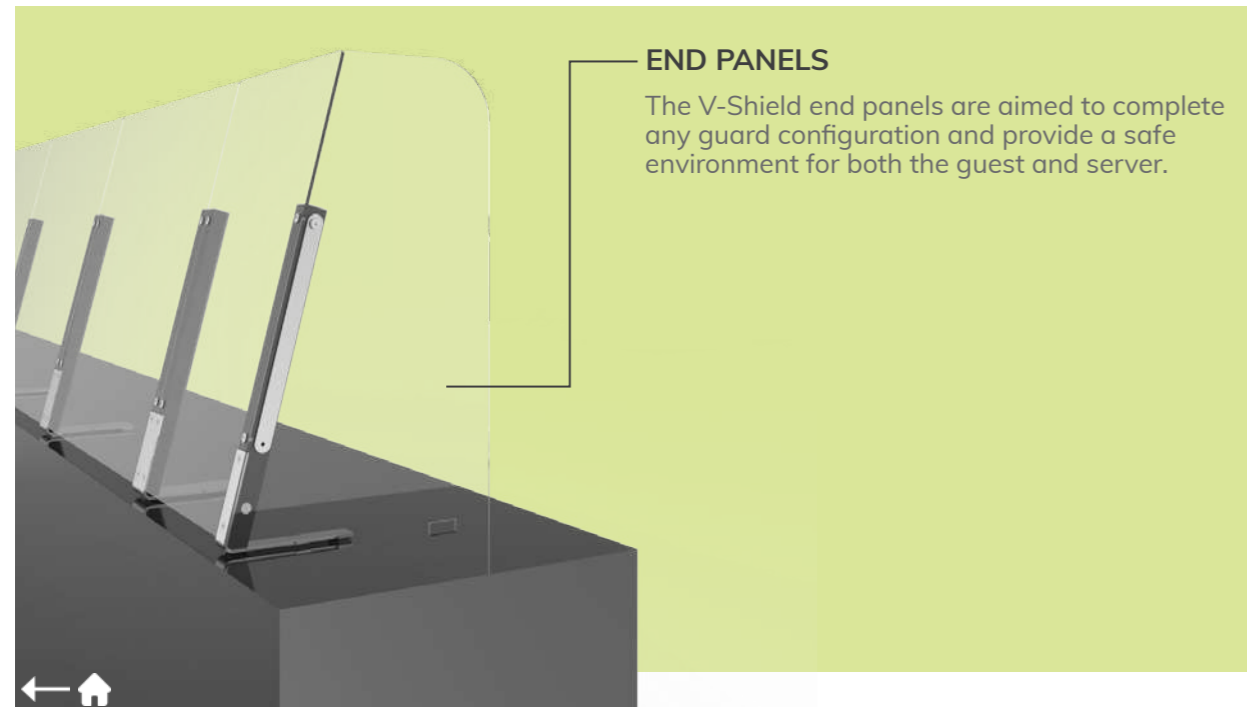

### END PANELS

The V-Shield end panels are aimed to complete any guard configuration and provide a safe environment for both the guest and server.



mogogo



Canvas  
SHELVING SYSTEM

2022/2023



Back to  
Catalog  
Selection

DISTRIBUTED BY:  steelite  
INTERNATIONAL





**BASE UNIT WITH CASTERS** | HANGER BAR | ANGLED SHELF | CRATE  
BOTTLE HOLDER | SHELF | SHELF RETAINING BAR | SHELF WITH BORDER | DIVIDER

## INDEX

- 4 About Mogogo
- 8 About the Canvas Collection
- 9 Materials
- 10 How It Works
- 12 Details
- 14 Single unit - basic shelves
- 18 Single unit - mixed add-ons
- 22 Single unit - crates and more
- 28 Multi unit configurations
- 34 System breakdown
- 36 Add-ons
- 40 Express your shelf





A MODULAR F&B  
FURNITURE BRAND

# BORN FROM A PASSION FOR **STYLE & GASTRONOMY**



Mogogo is led by designers and chefs that are aiming to introduce innovative, luxurious, and highly functional equipment to foodservice professionals.



LINENLESS



MODULAR



MOBILE



SUSTAINABLE



ADD ONS





**BACK BAR UNIT** MGCCAN05DCXW

**MIXOLOGY SERVICE CART** MGCRNX03BSXX

**ROUND POLO DISPLAY TABLE** MGCPPR01MBXX

**PRO BAR STATION** MGCMLC05GSXW







## ABOUT THE CANVAS COLLECTION

The Canvas Collection is an innovative shelving system for the hospitality sector, acting as a blank page allowing professionals to accomplish their creative vision. The collection is ideal as a back bar or for showcasing food and beverages and related products.

It combines function with uncluttered aesthetics to create this versatile range of shelving, taking into consideration the unique and challenging requirements of foodservice.



## MATERIALS

The usage of ecological materials is part of a global movement that aims to convey the message that luxury and sustainability go together. The bamboo frame is lightweight and highly structural, joined by decorative metal features to create a fine balance between traditional woodcraft and modern design.

Natural horizontal bamboo | Sandblasted Stainless Steel. NATURAL

Dark brown stained bamboo | Sandblasted Copper-plated Stainless Steel. DARK LUX



## HOW IT WORKS

Starting with an unfilled Canvas structure then adding selected fixtures, allows creating stations with specific needs, and the ability to seamlessly connect several units offers the flexibility to construct configurations fitting any size or shape of space.

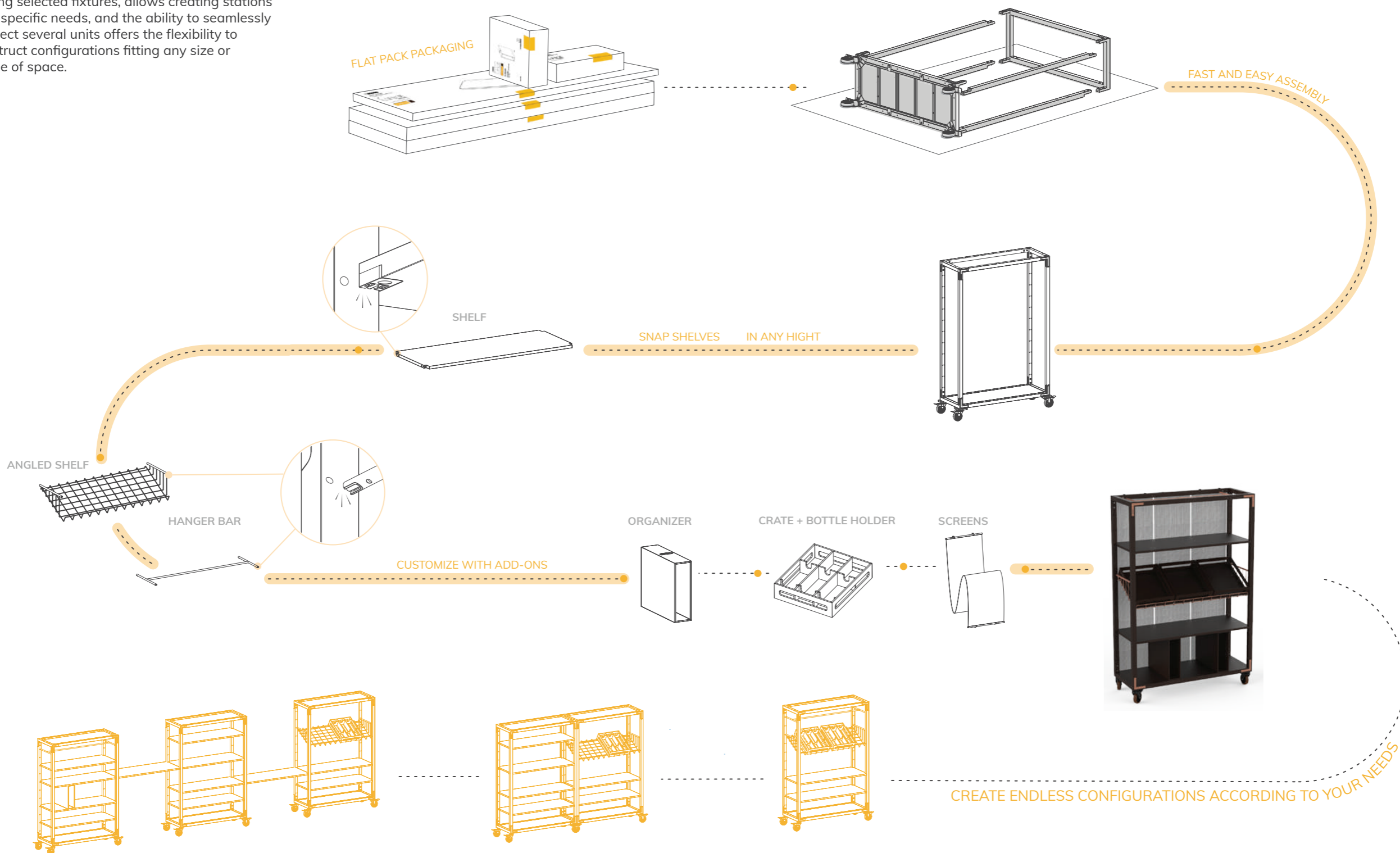

**DETAILS**

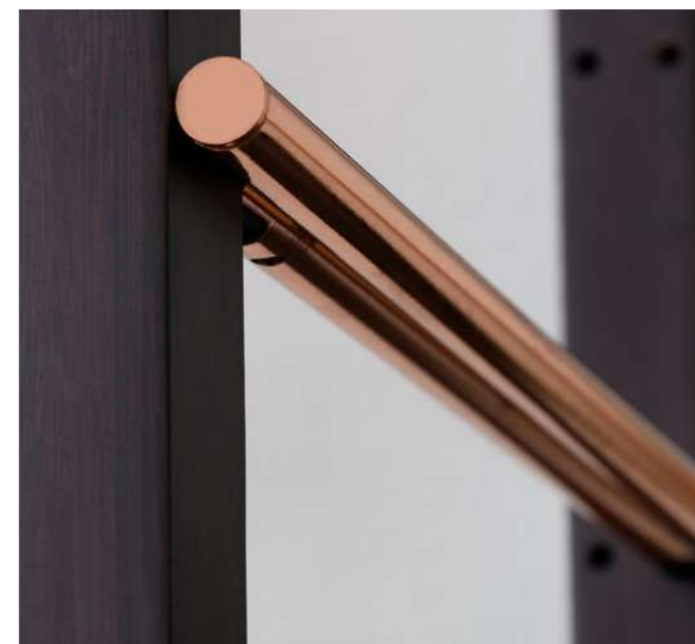
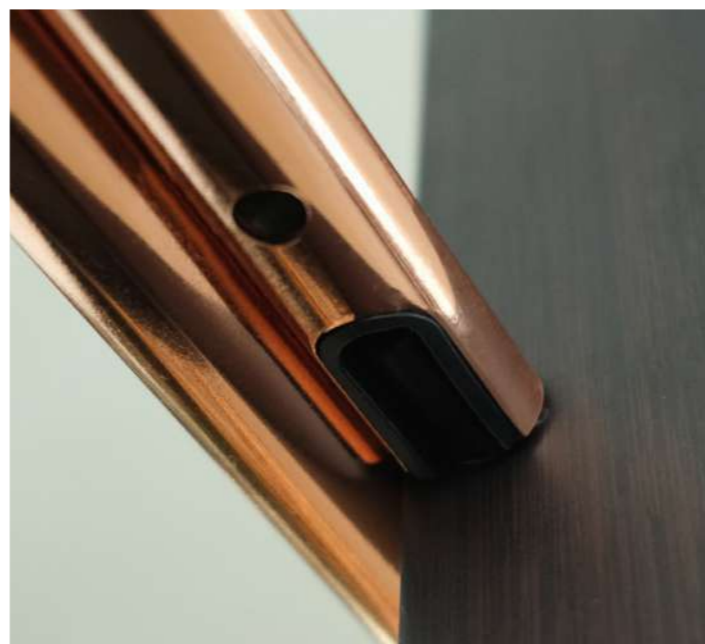





BUSSING STATION MGCCAN14NSXW



### SINGLE UNIT - BASIC SHELVES

Organization and accessibility are foundation stones for a functional station. Whether it is used front of house or behind the scenes, several shelves can be set at different heights in a matter of seconds creating a practical and stylish tool. The unit can be covered partially or completely with the use of easy to install screens.

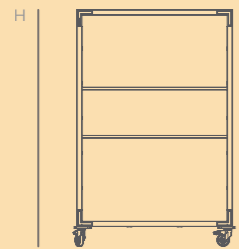
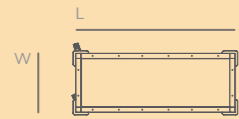

L48½" W18" H73½"  
L122.5cm W46cm H186cm



**TWO SHELF UNIT**

- NATURAL | CASTERS ..... MGCCAN17NSXW
- NATURAL | LEGS ..... MGCCAN17NSXF
- DARK-LUX | CASTERS ..... MGCCAN17DCXW
- DARK-LUX | LEGS ..... MGCCAN17DCXF

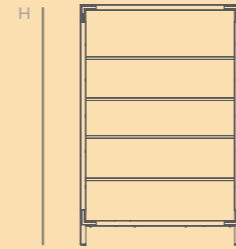
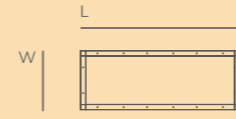

L48½" W18" H73½"  
L122.5cm W46cm H186cm



**FOUR SHELF UNIT**

- NATURAL | CASTERS ..... MGCCAN18NSXW
- NATURAL | LEGS ..... MGCCAN18NSXF
- DARK-LUX | CASTERS ..... MGCCAN18DCXW
- DARK-LUX | LEGS ..... MGCCAN18DCXF

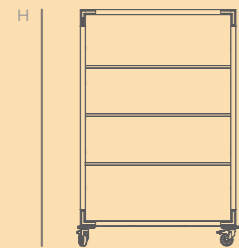
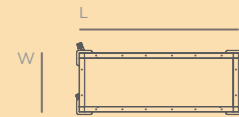

L48½" W18" H73½"  
L122.5cm W46cm H186cm



**THREE SHELF UNIT**

- NATURAL | CASTERS ..... MGCCAN14NSXW
- NATURAL | LEGS ..... MGCCAN14NSXF
- DARK-LUX | CASTERS ..... MGCCAN14DCXW
- DARK-LUX | LEGS ..... MGCCAN14DCXF

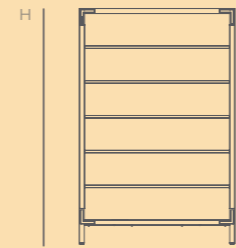
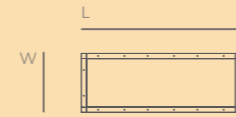

L48½" W18" H73½"  
L122.5cm W46cm H186cm



**FIVE SHELF UNIT**

- NATURAL | CASTERS ..... MGCCAN09NSXW
- NATURAL | LEGS ..... MGCCAN09NSXF
- DARK-LUX | CASTERS ..... MGCCAN09DCXW
- DARK-LUX | LEGS ..... MGCCAN09DCXF



## SINGLE UNIT - MIXED ADD-ONS

Mixing and matching is as simple as ever, and while installing the add-ons is user-friendly, the outcome is sophisticated and versatile. The shelf selection and designated add-ons are intended to offer you the freedom of expression when presenting food and beverage or your decoration of choice.



ROOM DIVIDER MGCCAN08DCXW

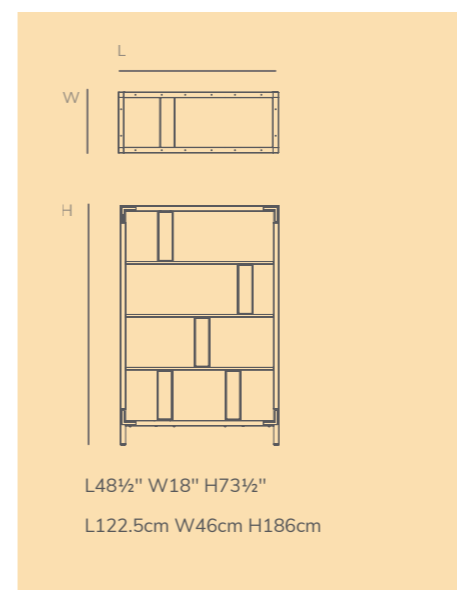
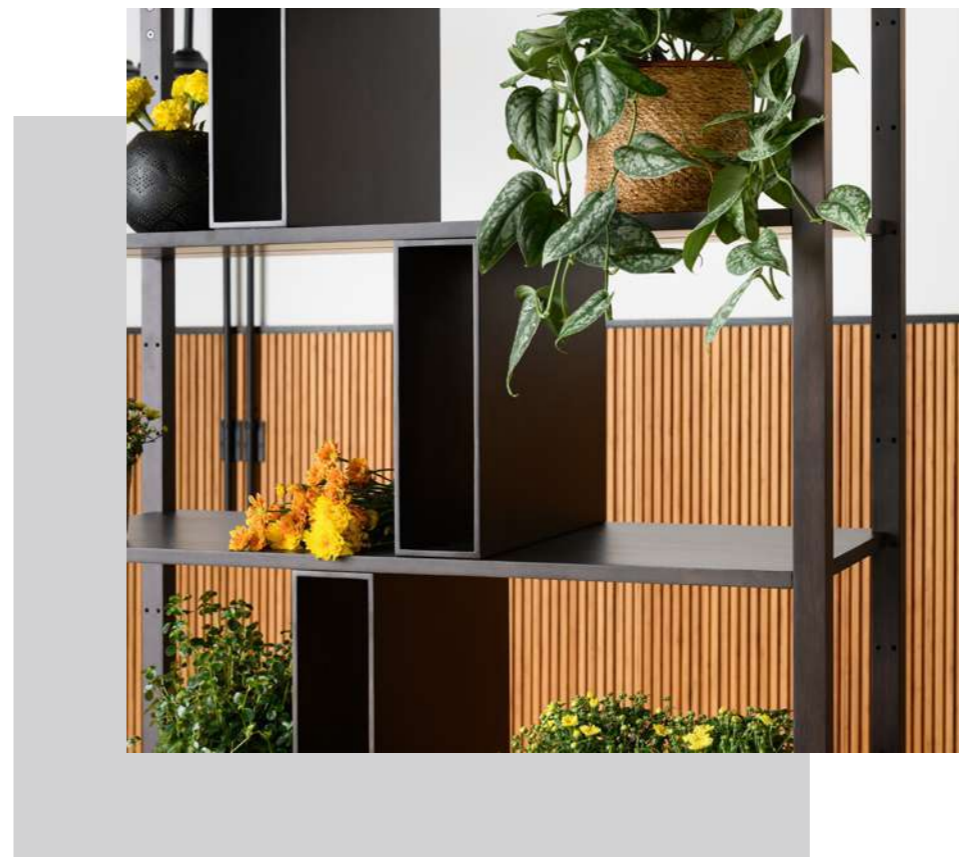

### ROOM DIVIDER

This Room Divider creates a sophisticated atmosphere and lining up multiple units can create division and a seamless appearance to any space. The shelf rail allows the dividers to be moved easily while in place to achieve a customized solution for your specific needs.



NATURAL | CASTERS.....MGCCAN08NSXW  
**NATURAL | LEGS.....MGCCAN08NSXF**  
 DARK-LUX | CASTERS.....MGCCAN08DCXW  
 DARK-LUX | LEGS.....MGCCAN08DCXF

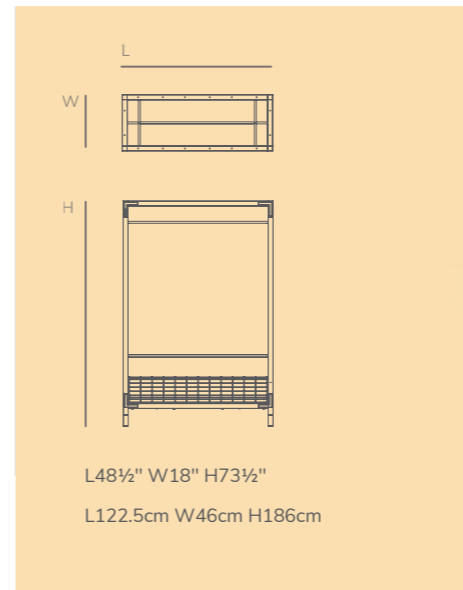

**DESSERT STATION**

This unit aims to focus attention on selected food items, such as exquisite "petit fours" or other food creations you wish to treat and showcase as jewels. It comes with two shelves and a slick sign to let your guests know what all the fuss is about.

- **NATURAL | CASTERS**.....MGCCAN15NSXW
- NATURAL | LEGS.....MGCCAN15NSXF
- DARK-LUX | CASTERS.....MGCCAN15DCXW
- DARK-LUX | LEGS.....MGCCAN15DCXF

**COAT RACK**

The Canvas system function can be stretched beyond the common usage to other hospitality areas, such as this portable coat rack station and many others, helping to overcome your daily challenges.

- NATURAL | CASTERS.....MGCCAN11NSXW
- NATURAL | LEGS.....MGCCAN11NSXF
- DARK-LUX | CASTERS.....MGCCAN11DCXW
- **DARK-LUX | LEGS**.....MGCCAN11DCXF

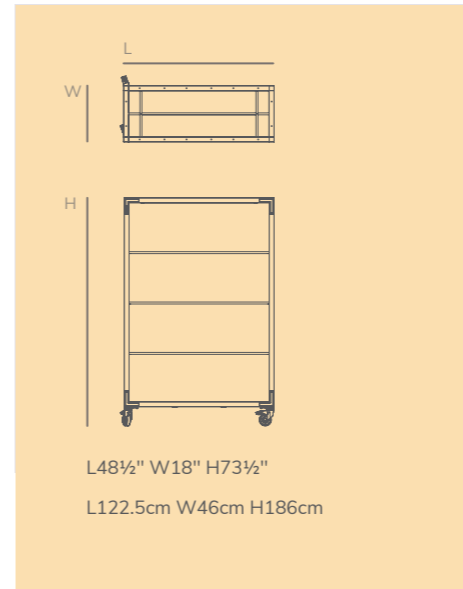
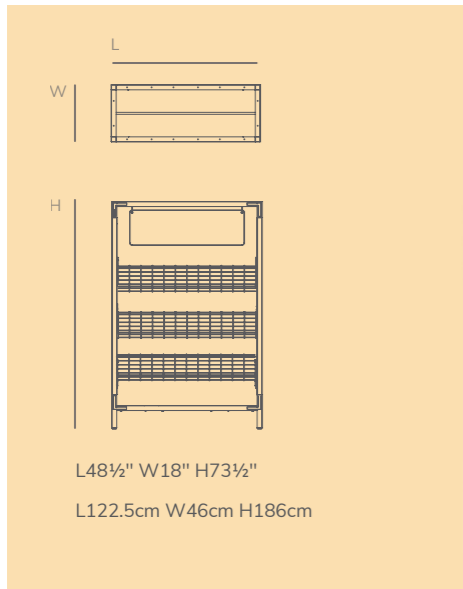

**ANGLED SHELF SIGNAGE UNIT**

This unit takes food presentation seriously! The angled stainless steel wire shelf offers food and related ingredients to be presented in an optimal style, and the hanging blackboard sign allows you to compose a unique story time after time.

- NATURAL | CASTERS.....MGCCAN16NSXW
- **NATURAL | LEGS**.....MGCCAN16NSXF
- DARK-LUX | CASTERS.....MGCCAN16DCXW
- DARK-LUX | LEGS.....MGCCAN16DCXF

**HANGING UNIT**

A clean and mentalistic hanging station offers to use the Canvas in exacting ways and discover new ideas to wow your guests, such as an indoor vertical herb garden or other ideas that you will come up with.

- NATURAL | CASTERS.....MGCCAN10NSXW
- NATURAL | LEGS.....MGCCAN10NSXF
- **DARK-LUX | CASTERS**.....MGCCAN10DCXW
- DARK-LUX | LEGS.....MGCCAN10DCXF





GRAB AND GO SIGNAGE UNIT MGCCAN03NSXW



### SINGLE UNIT - CRATES AND MORE

This group of configurations is defined by the crates they hold, allowing the operator to store and display most anything they wish. Combined with shelving and signage, they can perform many functions in a variety of locations while offering versatility and beauty.

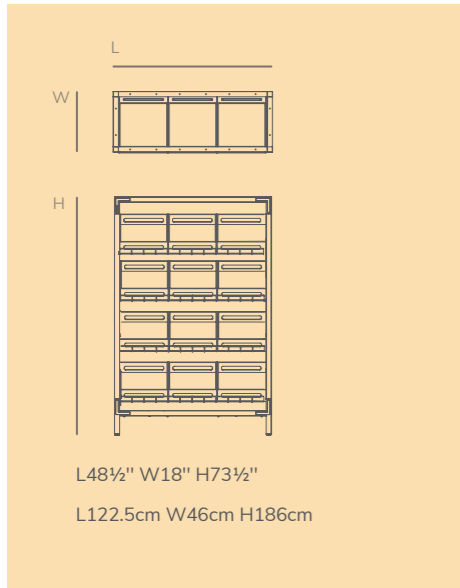

#### ANGLED SHELF UNIT

The wooden display crates with fresh vegetables, breads, combined with the olive oil bottles, bags of flour and other quality ingredients, are sure to tell your guest that a wonderful dish is on the way. Ultimately, completing the sensory experience that is so essential in hospitality!

- **NATURAL | CASTERS**.....MGCCAN12NSXW
- NATURAL | LEGS.....MGCCAN12NSXF
- DARK-LUX | CASTERS**.....MGCCAN12DCXW
- DARK-LUX | LEGS.....MGCCAN12DCXF

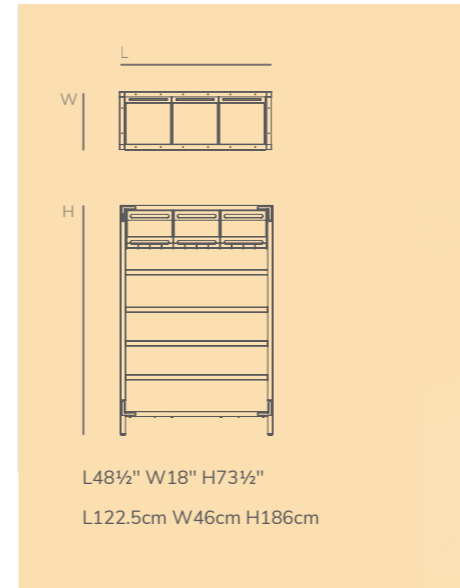

#### GRAB AND GO UNIT

Snacks, fruit and a variety of goods your guests desire to Grab and Go, will be displayed perfectly on this Canvas configuration. The angled shelf will improve visibility and create a complete experience.

- NATURAL | CASTERS.....MGCCAN02NSXW
- NATURAL | LEGS.....MGCCAN02NSXF
- DARK-LUX | CASTERS.....MGCCAN02DCXW
- **DARK-LUX | LEGS**.....MGCCAN02DCXF

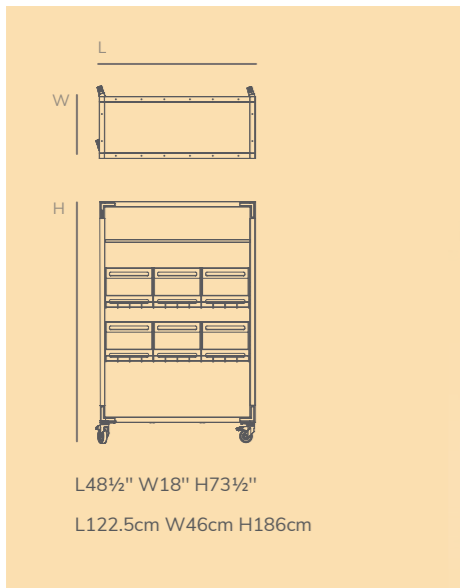

#### FARM TO TABLE

What is more appetizing than knowing that what you are about to eat is made from farm fresh ingredients. This Farm to Table Station was developed with this in mind and provides you a variety of display solutions that can effortlessly be customized according to the menu.

- NATURAL | CASTERS.....MGCCAN04NSXW
- NATURAL | LEGS.....MGCCAN04NSXF
- **DARK-LUX | CASTERS**.....MGCCAN04DCXW
- DARK-LUX | LEGS.....MGCCAN04DCXF

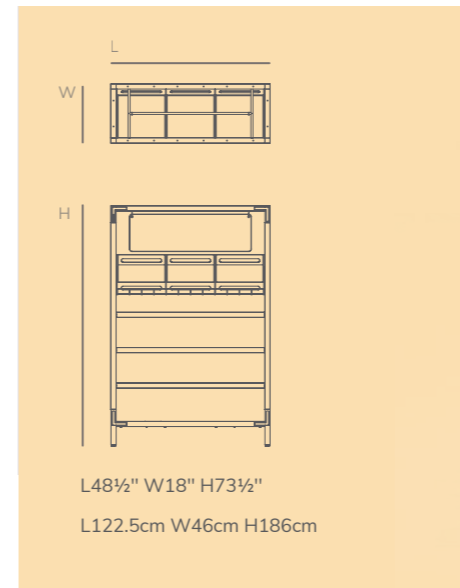

#### GRAB AND GO SIGNAGE UNIT

Like the Grab and Go unit above, it has the angled shelf, but also includes a chalkboard to make it very clear to your guests that tasty treats are available.

- NATURAL | CASTERS.....MGCCAN03NSXW
- **NATURAL | LEGS**.....MGCCAN03NSXF
- DARK-LUX | CASTERS.....MGCCAN03DCXW
- DARK-LUX | LEGS.....MGCCAN03DCXF





FARM TO TABLE MGCCAN04DCXW  
THREE SHELF UNIT MGCCAN14NSXW  
GRAB AND GO SIGNAGE UNIT MGCCAN03NSXW







**CENTER STAGE DISPLAY** MGCCAN19NSXW  
 (Shown with optional Golden-Brown screens)

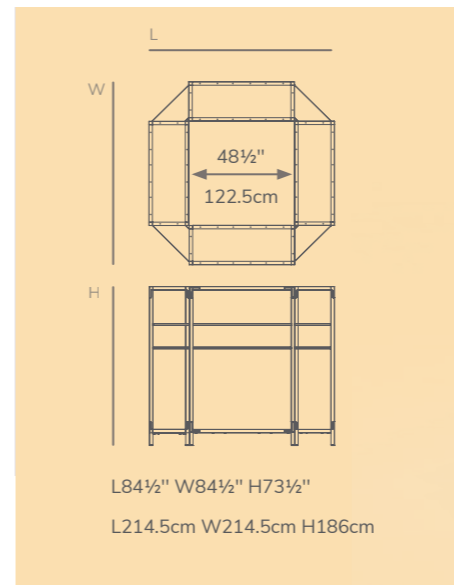

**CENTER STAGE DISPLAY**

Whether you're trying to make a statement in the middle of your room or wanting to utilize the space around that awkward pillar, this station will do both. The ability to connect the Canvas shelving units with the corner shelf connectors adds a dimension the traditional buffet furniture lacks and the results can be functional and stunning.

- NATURAL | CASTERS.....MGCCAN19NSXW
- NATURAL | LEGS.....MGCCAN19NSXF
- DARK-LUX | CASTERS.....MGCCAN19DCXW
- DARK-LUX | LEGS.....MGCCAN19DCXF

**MULTI UNIT CONFIGURATIONS**

If your space allows the use of several units, the addition of the unit connectors, straight shelves and corner shelves, is a cost effective way to add additional display space.

In addition, it creates straight or angled structures that act as living walls, allowing you to express your artistic talents.

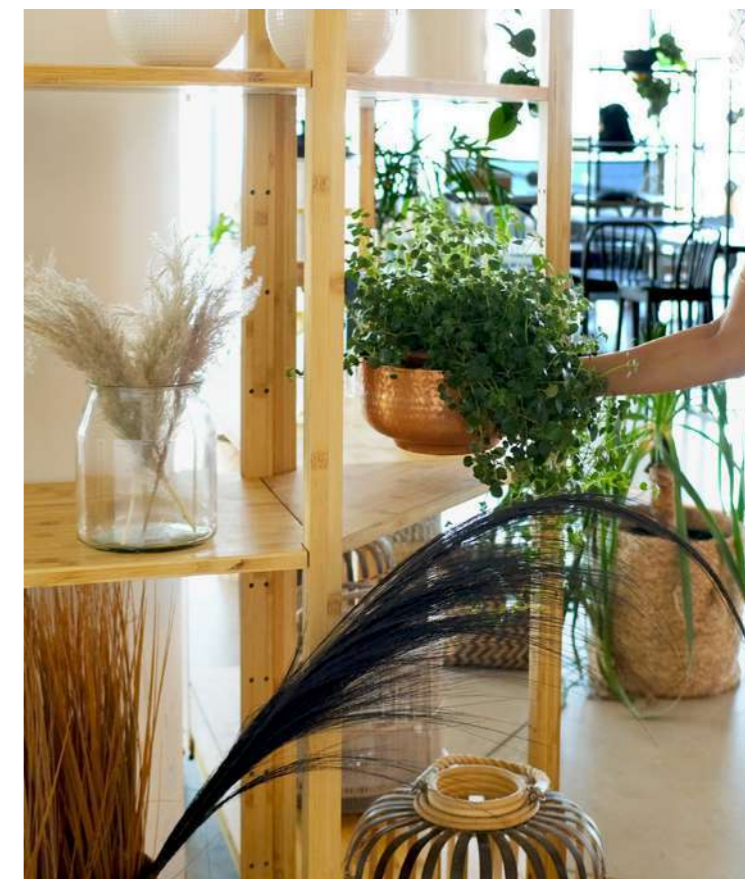



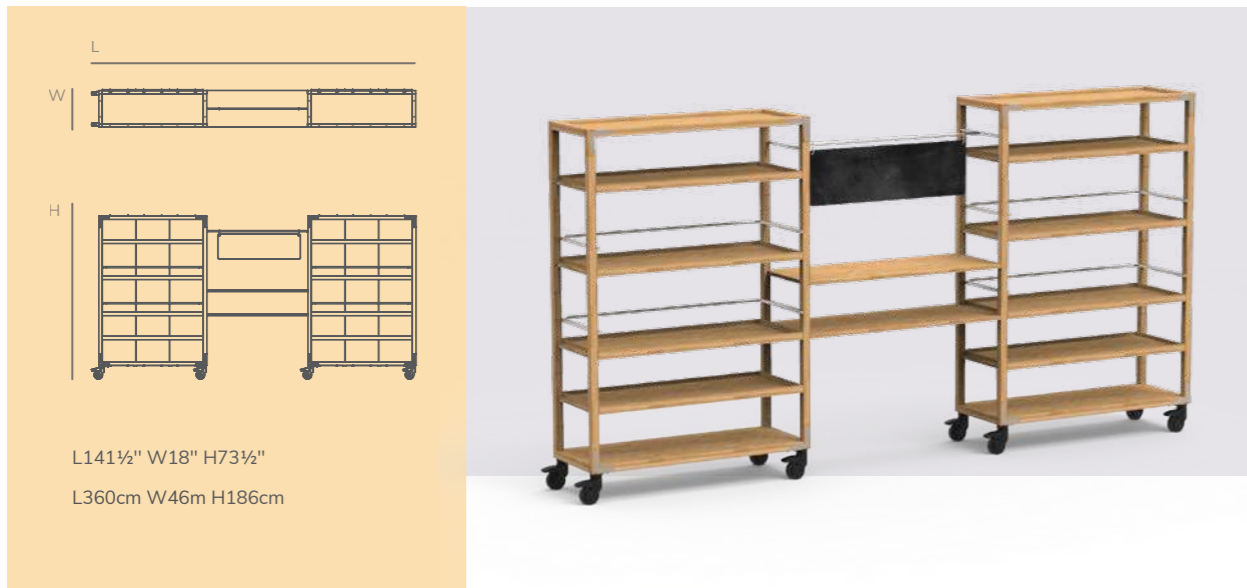

#### BACK BAR UNIT

A luxurious back bar tells a story and lets your guest know that they have arrived at their destination and will be treated accordingly. Whether they seek a revitalizing cocktail or a glass of wine, the look and feel you create will set the tone.

■ NATURAL   CASTERS	MGCCAN05NSXW
NATURAL   LEGS	MGCCAN05NSXF
■ DARK-LUX   CASTERS	MGCCAN05DCXW
DARK-LUX   LEGS	MGCCAN05DCXF



#### COFFEE LOUNGE

Double espresso, butter Croissant, and the newspaper of the day! No matter where you wake up, it's a great way to start another busy day. The flexibility of the Canvas Collection can turn your pleasant but hard to utilize space into an attractive area that gives a look and feel of a neighborhood café.

NATURAL   CASTERS	MGCCAN07NSXW
NATURAL   LEGS	MGCCAN07NSXF
DARK-LUX   CASTERS	MGCCAN07DCXW
■ DARK-LUX   LEGS	MGCCAN07DCXF

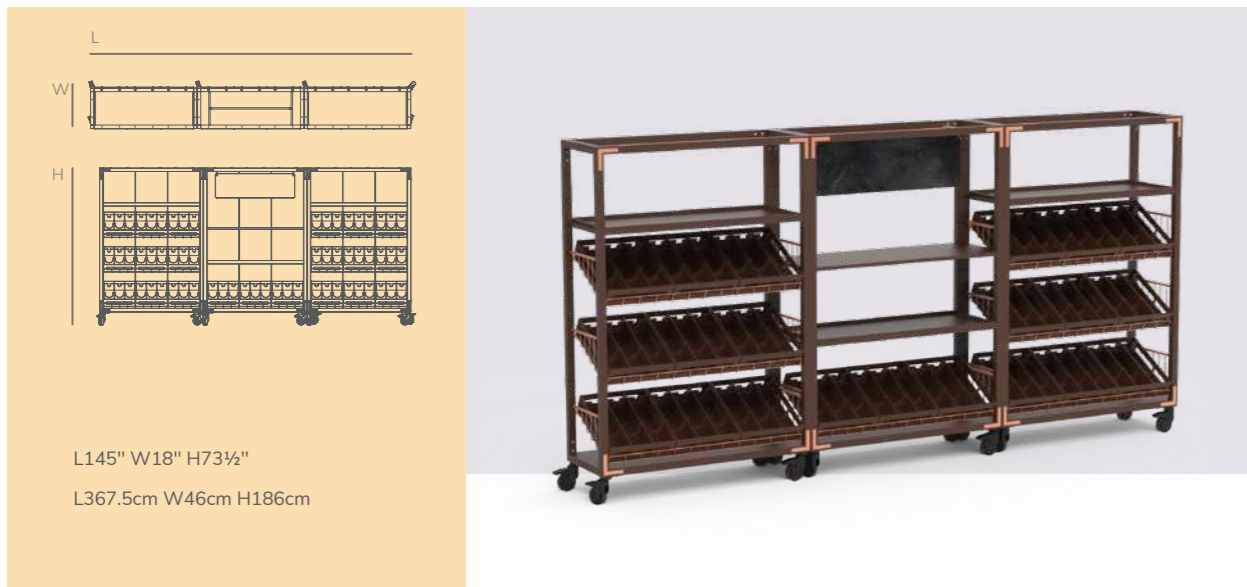

#### WINE DISPLAY

At the end of the day, a glass of red wine, cheese, and snacks can turn into a worthy memory. This elegant configuration allows for the serving of wine and related foods in a way that is sure to impress. Each unit comes with casters allowing for easy mobility when moving from one event to another.

NATURAL   CASTERS	MGCCAN06NSXW
NATURAL   LEGS	MGCCAN06NSXF
■ DARK-LUX   CASTERS	MGCCAN06DCXW
DARK-LUX   LEGS	MGCCAN06DCXF



#### SELF SERVICE

Juice boxes or sweets? What decorations will enhance the experience to create something modern and minimalist, or a warmer and more country style. The self service configuration gives you the tools to express your desired concept no matter what the occasion is.

■ NATURAL   CASTERS	MGCCAN01NSXW
NATURAL   LEGS	MGCCAN01NSXF
DARK-LUX   CASTERS	MGCCAN01DCXW
DARK-LUX   LEGS	MGCCAN01DCXF

CDG	245 - 244	CHECK-IN
CX	0708	204 - 247
CZ	7122	2 KIOSK
DY	3581	2 KIOSK
EI	0645	1
EK	0140	1 171 - 178
CHECK-IN		



**COFFEE LOUNGE MGCCAN07DCXW**  
(shown with optional Charcoal-Black Screens)

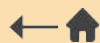





MGCCAN04DCXW

## SYSTEM BREAKDOWN

Starting with a blank rectangular structure (on casters or legs) acting as an empty page that awaits your ideas and needs to be explored. Our Canvas Shelving System was born from the basic idea that your F&B Furniture should adapt to your ever-varying needs during different functions. It allows you to pick and choose basic elements such as shelves with or without borders, hanging bars, signs, organizers, and more.

## BUILD YOUR OWN UNITS

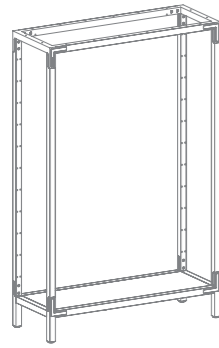

**EMPTY UNIT WITH LEGS**  
L48½" W18" H73½"  
L122.5cm W46cm H186cm



Natural horizontal bamboo sandblasted stainless steel

MGCCAN13NSXF



Dark brown stained bamboo Sandblasted Copper plating

MGCCAN13DCXF

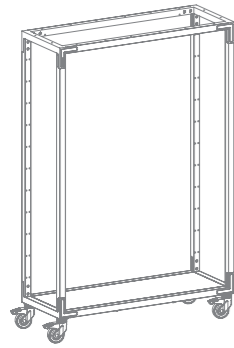

**EMPTY UNIT WITH CASTERS**  
L48½" W18" H73½"  
L122.5cm W46cm H186cm

MGCCAN13NSXW

MGCCAN13DCXW

## ADD-ONS SHELVES



Natural horizontal bamboo sandblasted stainless steel

MGSCANBM0201



Dark brown stained bamboo Sandblasted Copper plating

MGSCANDB0201



**SHELF**  
L46½" W18" H0.8"  
L118.5cm W46cm H2cm



**SHELF WITH BORDER**  
L46½" W18" H1½"  
L118.5cm W46cm H4cm



**TOP FRAME SHELF**  
L45" W15" H0.8"  
L114.5cm W38cm H2cm

MGSCANBM0601

MGSCANDB0601

## ADD-ONS



Natural horizontal bamboo sandblasted stainless steel

MGSCANSS0101



Dark brown stained bamboo Sandblasted Copper plating

MGSCANSC0101



**HANGER BAR**  
Comes with 5 Hooks  
L46½" W15" H½"  
L118cm W38cm H1.6cm



**TOP FRAME HANGER BAR**  
Comes with 5 Hooks  
L38" W16½" H½"  
L96cm W41.5cm H1.5cm

MGSCANSS0201

MGSCANSC0201

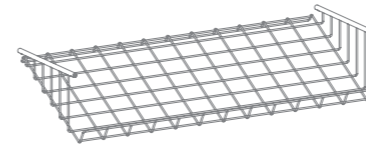

**ANGLED SHELF**  
Can fit up to 3 crates  
L46½" W18" H9½"  
L118cm W46cm H24cm

MGSCANSS0301

MGSCANSC0301



**SHELF RETAINING BAR**  
L46½" W18" H0.6"  
L118cm W46cm H1.6cm

MGSCANSS0401

MGSCANSC0401

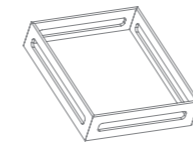

**CRATE**  
L17½" W14.½" H4"  
L44cm W37.5cm H10cm

MGSCANBM0301

MGSCANDB0301

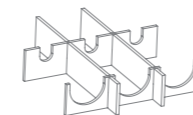

**BOTTLE HOLDER**  
fits Crate  
L16½" W14" H3½"  
L42.5cm W36cm H8.5cm

MGSCANBM0401

MGSCANDB0401

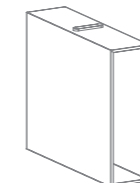

**ORGANIZER**  
L18" W4½" H15½"  
L46cm W12cm H39cm

MGSCANBM0501

MGSCANDB0501



## ADD-ONS

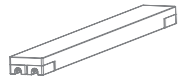

**UNIT CONNECTORS**  
To connect two units | Set of 2  
L15" W1.5" H0.8"  
L38cm W4cm H2cm



Natural horizontal  
bamboo sandblasted  
stainless steel

MGSCANBM0901



Dark brown stained  
bamboo Sandblasted  
Copper plating

MGSCANDB0901



**CORNER SHELF CONNECTOR**  
To connect two units in 90° | Set of 2  
L18" W18" H0.8"  
L46cm W46cm H2cm

MGSCANBM1101

MGSCANDB1101

## MISCELLANEOUS ADD-ONS

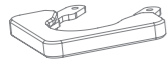

**BUMPERS**  
set of 4  
L5" W5" H0.6"  
L12cm W12cm H1.6cm

MGSCANSM0801

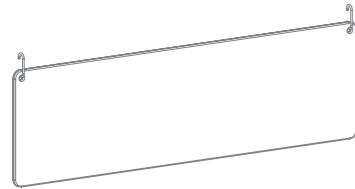

**SIGN**  
Comes with 2 Hooks  
L37" W11½" H½"  
L94cm W29cm H1cm

MGSCANSM0901

## SCREENS

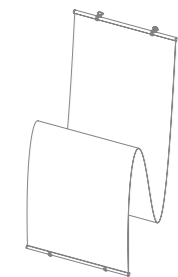

**EASY TO INSTALL SCREENS**  
Set of 5- Available in various colors  
L67" W15"  
L170cm W38cm

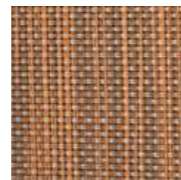

Golden-Brown

MGSCANPV0201



Jungle-Green

MGSCANGP0101

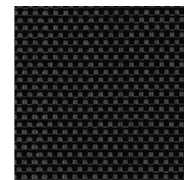

Charcoal-Black

MGSCANPV0101



COAT RACK MGCCAN11NSXW

Sketch your own Canvas configuration by choosing from a variety of shelves and add-ons using the 2D drawing to explore options.

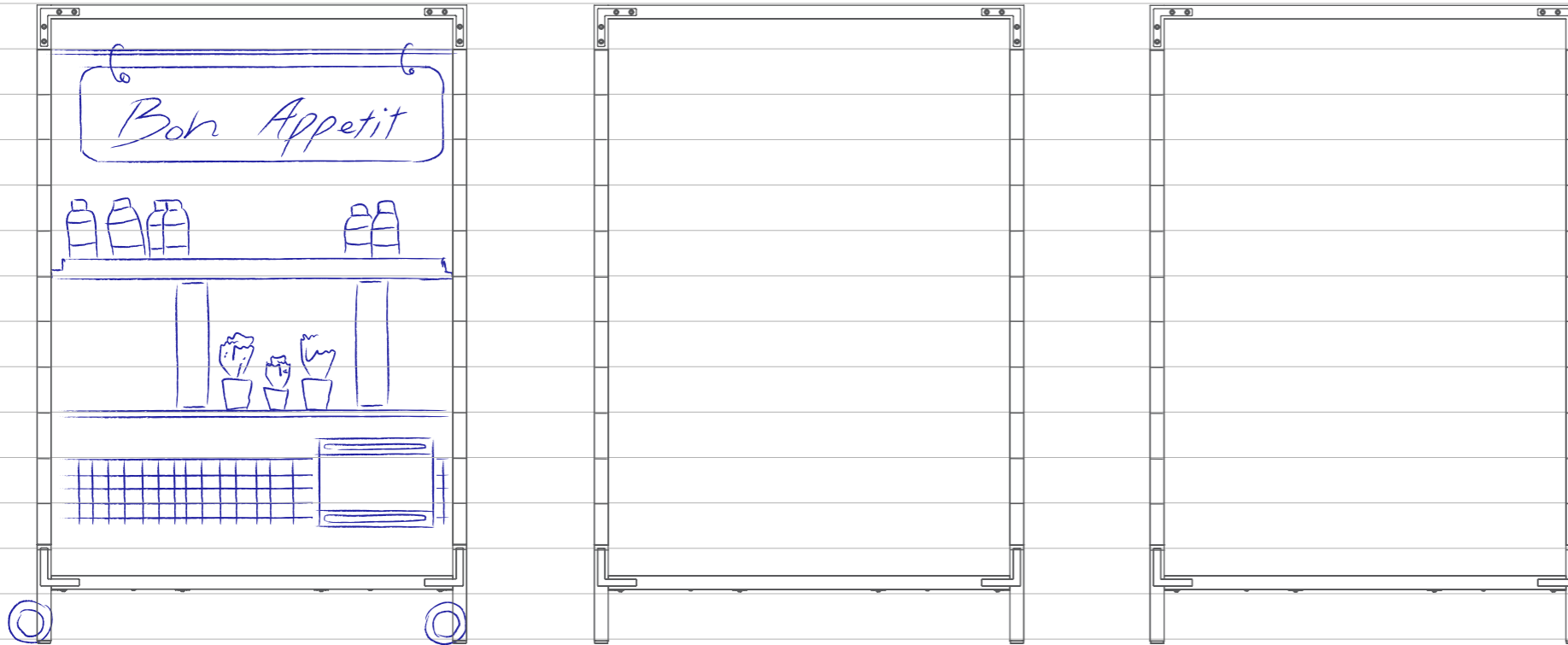

- TOP FRAME SHELF 
- SHELF 
- ANGLED SHELF 
- SHELF WITH BORDER 
- SHELF RETAINING BAR 
- SIGN 
- TOP FRAME HANGER BAR 
- HANGER BAR 
- CRATE 
- BOTTLE HOLDER 
- BUMPERS 
- ORGANIZER 

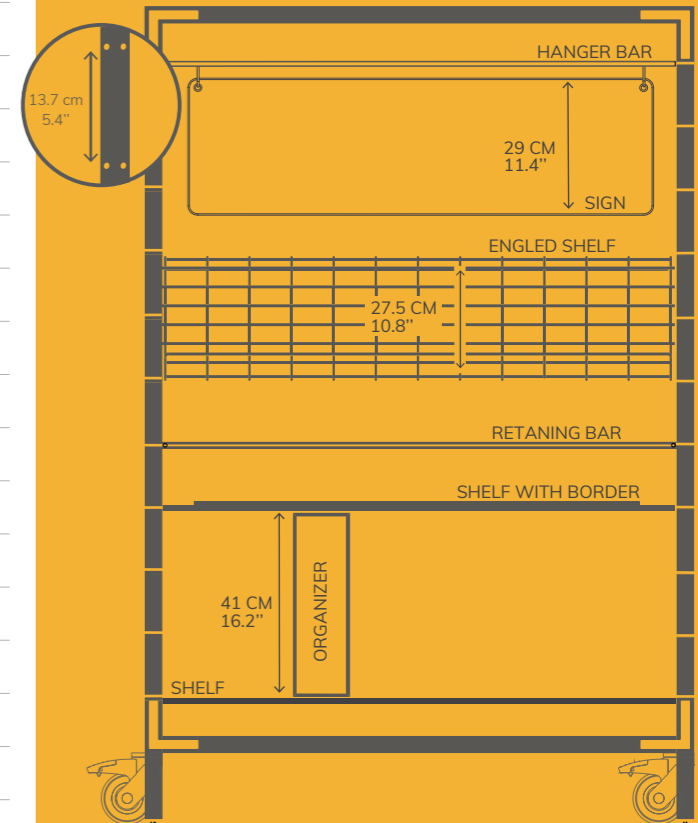
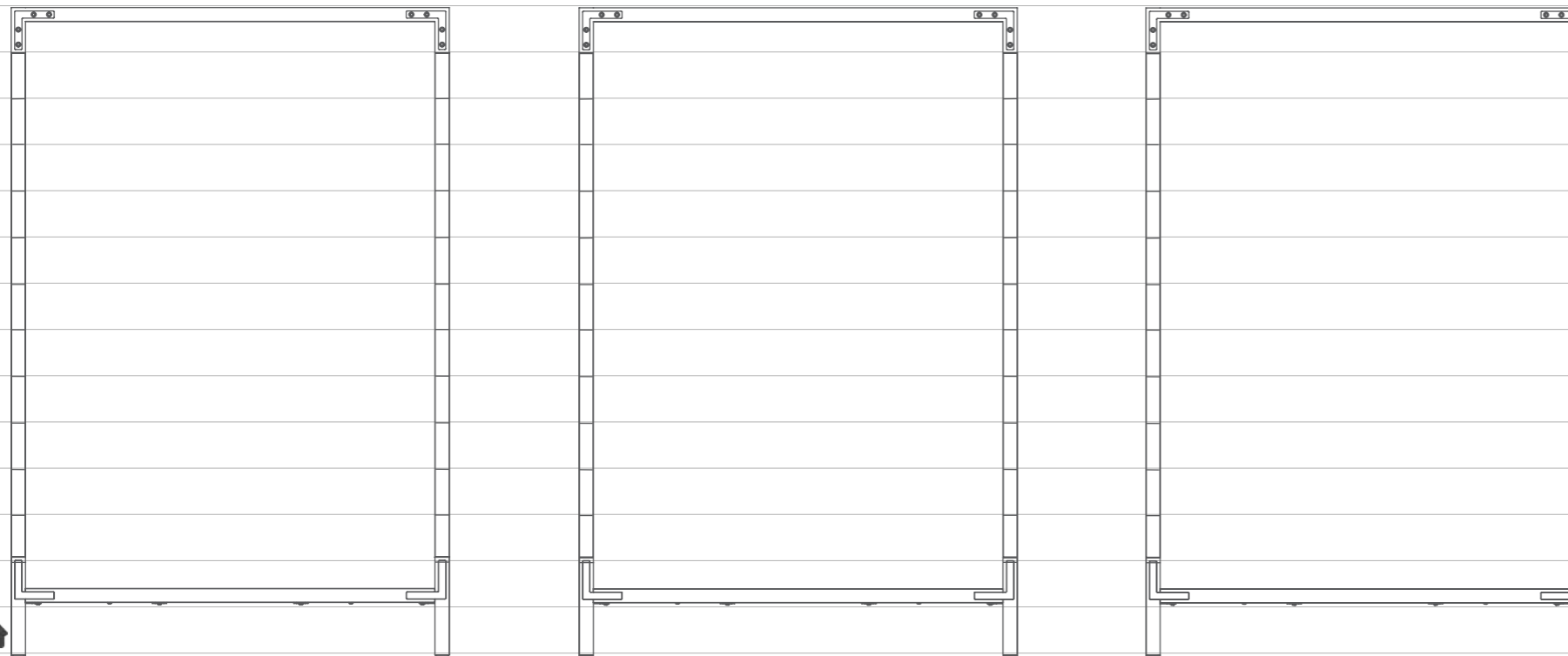





BUFFET SOLUTIONS

[www.mogogo-buffet.com](http://www.mogogo-buffet.com)

[info@mogogo-buffet.com](mailto:info@mogogo-buffet.com)



Modular  
SYSTEM



Roll'n  
SERVICE CARTS



Polo  
TABLES



Clix  
TABLES

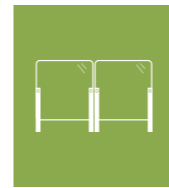

V-Shield  
SYSTEM



Canvas  
SHELVING SYSTEM







BUFFET SOLUTIONS

www.mogogo-buffet.com  
info@mogogo-buffet.com



www.steelite.com  
facebook.com/steeliteinternationalEMEA  
twitter.com/SteeliteEMEA  
instagram.com/steelite\_emea

United Kingdom &  
Republic of Ireland  
Steelite International Ltd  
Orme Street  
Stoke-on-Trent  
ST6 3RB  
England

UK Distribution Centre  
Steelite International Ltd  
Station Street  
Stoke-on-Trent  
ST6 4NB  
England  
Telephone +44 (0)1782 821 000  
Fax +44 (0)1782 819 926  
Email headoffice@steelite.com

London Showroom  
Steelite International Ltd  
75 Wells Street  
2nd Floor South  
London  
W1T 3QH  
Telephone +44 (0)1782 249 599  
Email london@steelite.com



Modular  
SYSTEM



Roll'n  
SERVICE CARTS



PoLo  
TABLES



Clix  
TABLES

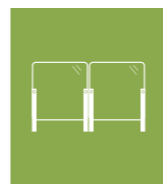

V-Shield  
SYSTEM



Canvas  
SHELVING SYSTEM

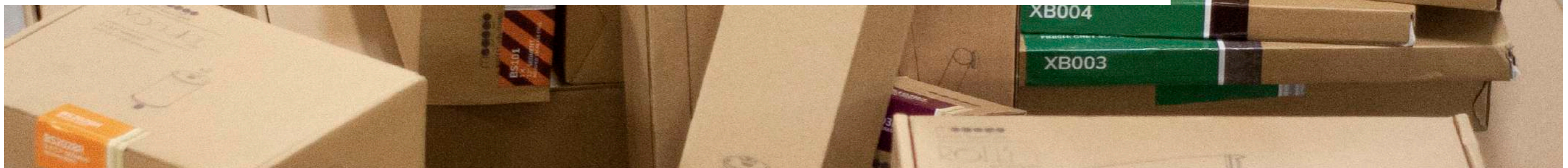





[www.mogogo-buffet.com](http://www.mogogo-buffet.com)  
[info@mogogo-buffet.com](mailto:info@mogogo-buffet.com)



[www.steelite.com](http://www.steelite.com)  
[facebook.com/steeliteinternationalEMEA](https://facebook.com/steeliteinternationalEMEA)  
[twitter.com/SteeliteEMEA](https://twitter.com/SteeliteEMEA)  
[instagram.com/steelite\\_emea](https://instagram.com/steelite_emea)

[www.steelite.com](http://www.steelite.com)

America  
154 Keystone Drive  
New Castle, Pennsylvania 16105  
toll free: 800-367-3493  
Telephone: 724-856-4900  
Fax: 724-856-7925  
Email: [usa@steelite.com](mailto:usa@steelite.com)

Canada  
Unit 2, 26 Riviera Drive Markham,  
Ontario L3R 5M1  
Toll Free: 800-465-4284  
Telephone: 905-752-1074  
Fax: 905-752-1120  
Email: [canada@steelite.com](mailto:canada@steelite.com)

United Kingdom & Republic of Ireland Steelite  
International Ltd Orme Street  
Stoke-on-Trent ST6 3RB  
England  
Telephone: +44 (0)1782 821 000  
Fax: +44 (0)1782 819 926  
Email: [headoffice@steelite.com](mailto:headoffice@steelite.com)

Showrooms available by appointment:  
Atlanta • Chicago • Cincinnati • Las Vegas  
London, UK • Los Angeles • New York  
Stoke-on-Trent • Toronto,

