



Modular
SYSTEM



Roll'n
SERVICE CARTS



Cix
TABLES



mogogo
BUFFET SOLUTIONS



PoLo
TABLES



V-Shield
SYSTEM



Canvas
SERVING SYSTEM



DISTRIBUTED BY:  steelite
INTERNATIONAL

2022/2023
COLLECTIONS

mogogo
BUFFET SOLUTIONS



Modular
SYSTEM

2022/2023

DISTRIBUTED BY:  steelite
INTERNATIONAL



CLASSIC SMALL UNIT MG CMLX03 GSXF

INDEX

NEW New Products

 Chef

 Waiter

 Bartender

 P. 20 See Page



A PROFESSIONAL
FOOD & BEVERAGE
FURNITURE COMPANY

BORN FROM AN INTERDISCIPLINARY PASSION FOR **Design x Food**



Mogogo is led by designers and chefs that are driven by the desire to introduce new, beautiful, and functional products to the market, with an environmentally friendly philosophy in mind.

WE PUSH
THE CREATIVE ENVELOPE
OF FUNCTION AND INNOVATION.



LINENLESS



MODULAR



MOBILE



SUSTAINABLE



ADD ONS



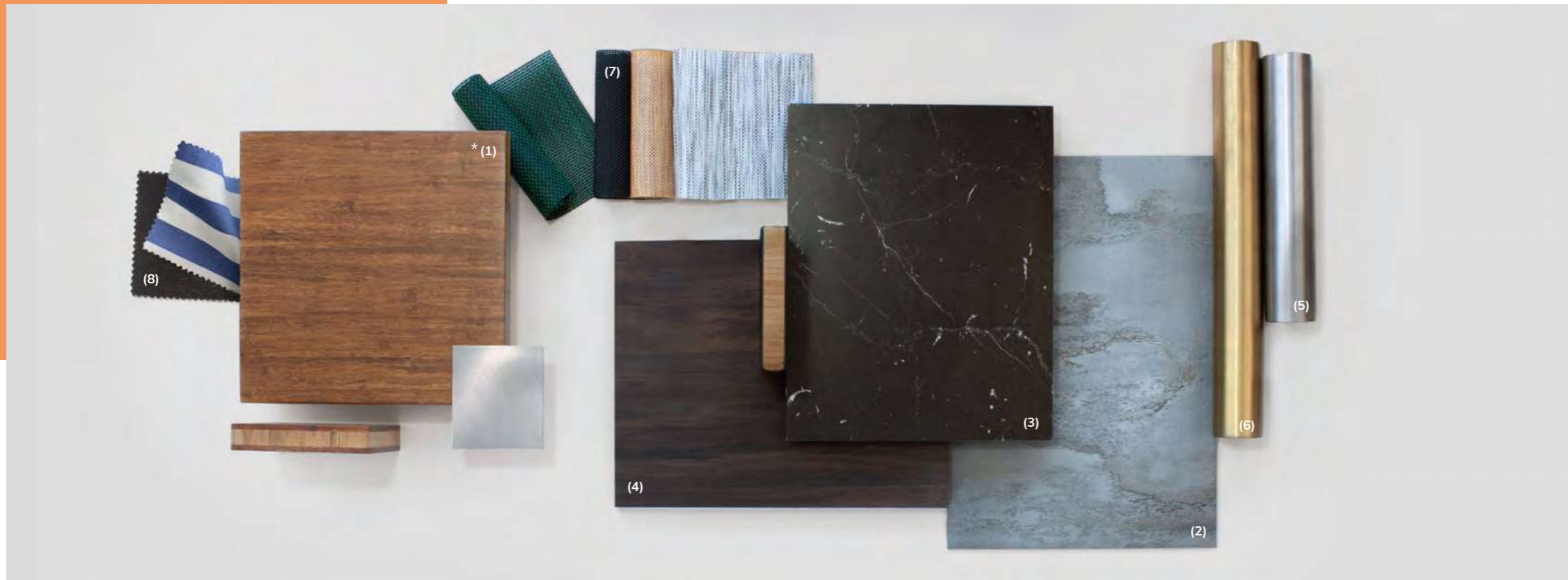

ABOUT MODULAR COLLECTION

Mogogo's flagship collection, the Modular System, allows you to use the same components in various ways to create different configurations of products. Our Modular System Line is composed of our Classic and Creative Ranges, and a large variety of complementary accessories.

Our Classic Range consists of buffet tables and shelves that fit each other seamlessly, functioning as building blocks to the Mogogo System. The classic range is characterized by sleek linear design, adaptable to both traditional and more modern, edgier looks.

Our Creative Range comes with a curved design concept. Our Creative system is patented and offers unique features based on our vast experience in large food service operations.

Our stations are carefully designed maintaining a delicate balance between high functionality, durability, and mobility; all in perfect symbiosis with high design standards, providing an ideal solution for the Food and Beverage industry.

 Classic Range |  Creative Range

MATERIALS

Joining our Bamboo **(1)*** collection is our innovative BHP material. BHP is a newly composed material that arrived after two years of intense R&D. It merges layers of High-Pressure Laminate with a Vertical Bamboo core (Mogogo's expertise) creating a lighter yet durable panel that offers new textures and colors. This new material combines the advantages of both bamboo and HPL, perfect for the ever-changing needs of the hospitality industry. BHP is available in a variety of finishes that resemble natural materials such as Grey Slate, Nero Marquina Marble, and Bengali Mango Wood **(2-4)**, making it easy to match with any event and decor. The innovative bamboo core of the BHP goes in line with Mogogo's sustainability motto while the HPL's outer coating is durable for different environments, hygienic and easy to clean.

Modular segments come in 2 finishes: brushed stainless steel **(5)** and brushed brass **(6)**.

Easily cover up parts of your buffet stations with our original quick covers **(7)**. Both durable and easy to clean, they come in 4 different color options allowing you to easily match any of your event color schemes.

For that extra outdoor feel, add a canopy **(8)** to your buffet station, made from a sturdy Cordura fabric known for its resistance to abrasions, tears, and scuffs.

* High-Density Bamboo finish only available in North America

HOW IT WORKS

The Mogogo Modular System is composed of individual parts, which can be assembled to create endless configurations. These individual components sit at the core of the Mogogo Modular System. In fact, they are utilized as the base for creating Action Stations, Buffet Stations, Bar Stations, and more when combined with add-ons, in order to offer the perfect customized touch for all of your buffet solution needs.

All Buffet Stations have essential elements: tabletops, mid-part segments, and leg segments (permanent or mobile casters). From there, you can start choosing your add-ons: different shelves, sign posts, quick covers, arches, etc., for the ultimate customization.

What is unique about Mogogo's configurations is the freedom of building any stations you want from the exact same parts. Start with a Basic Station and add shelves: it makes for the ideal Breakfast Station. Add a different tabletop and covers: it becomes an elegant Bar Station.

When the sum of parts is bigger than the whole, we deliver on unique and endless possibilities.

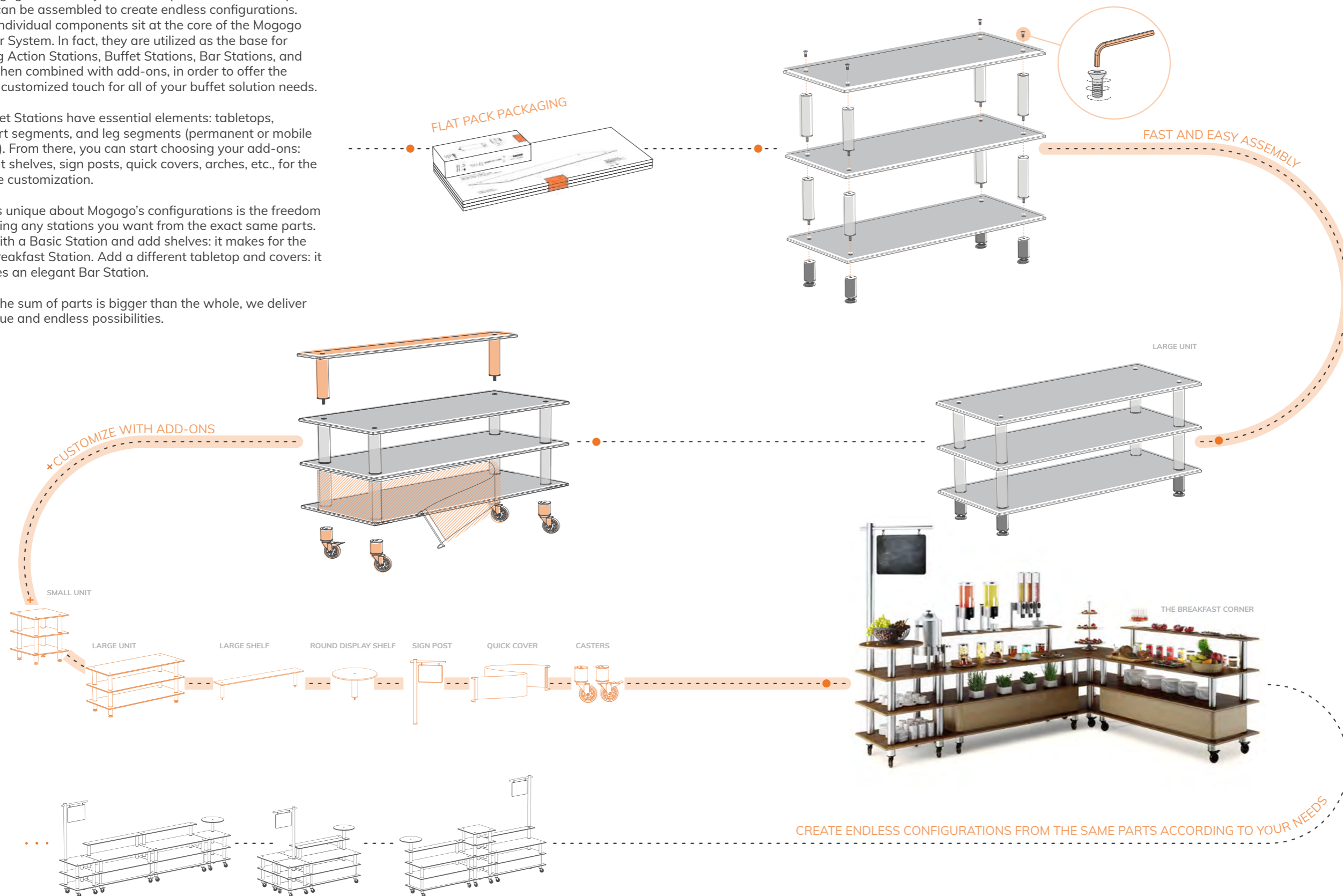



MG CMLB10 GBBW (shown with optional quick covers)



MG CMLA06 BSXW (shown with optional quick covers)

Mogogo's unique Modular system allows its stations to be extremely versatile and functional. By adding different elements you can custom fit any event or venue. These add-ons are easy to incorporate and provide edgy looks that will stand out.



MG CMLD12 MSXW (shown with optional quick covers)

ADD-ON COMBINATIONS



MG CMLB11 MBXW (shown with optional quick covers)



MG CMLB12 BBXF



*
The different finishes combined with brass or stainless steel create infinite options for styling.



MG CMLC05 MSXW (shown with optional quick covers)





OPEN C SERVING STATION MG CMSA01 WBXF
(shown with optional Golden-Brown quick covers)

ACTION STATIONS

Guests' fascination with chefs, food preparation, and presentation around the Action Station continues to grow and evolve in events today - it's a great way to add some spice and surprise to your culinary landscape.

Mogogo's Action Stations are designed to enhance the interactive experience of your guests through elegant design, while providing chefs and F&B professionals all the functional elements they are looking for. From an omelet station to a make-it-your-own dish station, Mogogo Action Stations are extremely modular; our ever-expanding line of add-ons and a wide range of tabletops deliver functionality and authenticity.

Cooking in front of the guest entices all their senses - and we believe beautifully crafted furniture is part of the experience.

MATERIAL GUIDE

Customize your Modular Stations by choosing from the different colors and finishes available.

Simply choose your preferred design combination by inserting the corresponding letter to its designated space as demonstrated below.

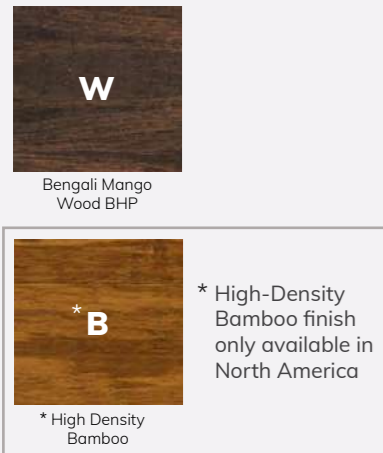
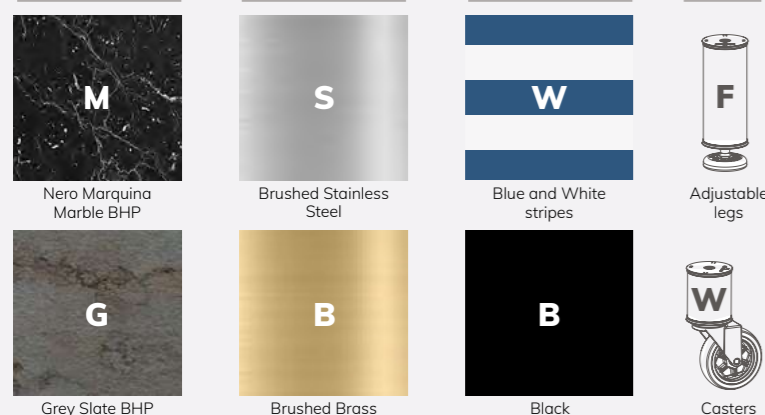
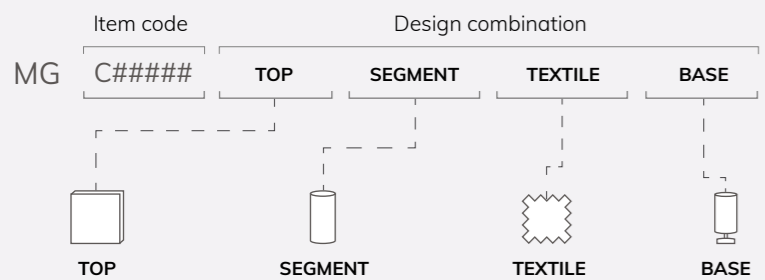

EXAMPLE:
MG CMLB10 **GBWF** =

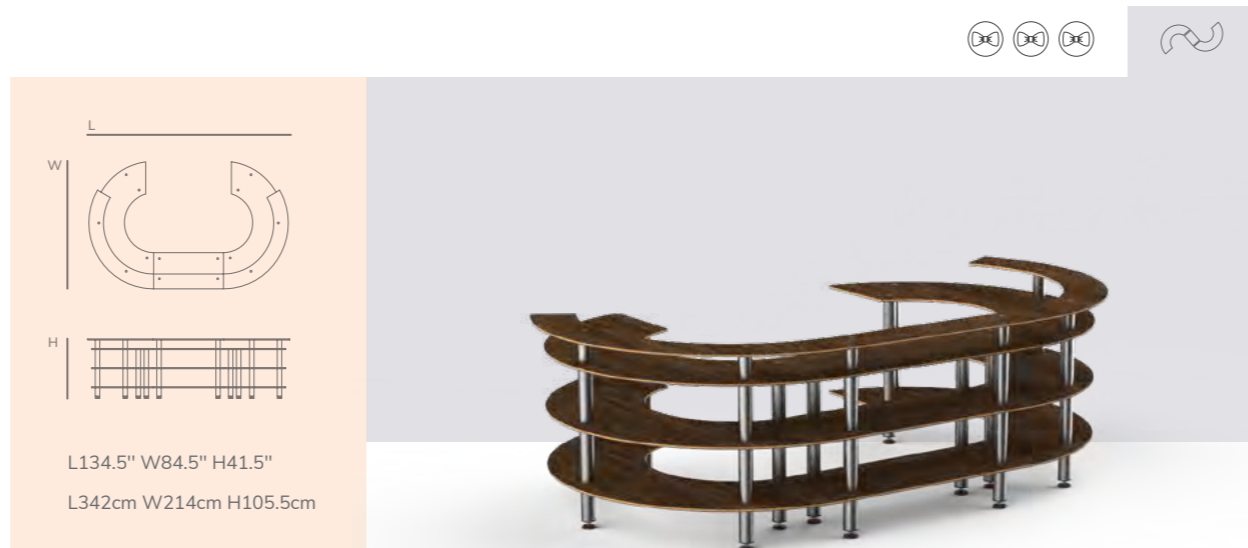

OPEN C SERVING STATION

Neither round nor square, this station creates a minimalist and functional approach, designed to serve large crowds with minimal effort.

MG CMSA01 **WSXF**



CLASSIC CANOPY COOLING STATION

Chilled tabletop for a contemporary Food Market feel with hygienic stainless steel top and insulated ice bin with drain.

(shown with optional Silver-Grey quick covers)

MG CMLA01 **MSWF**



CREATIVE DIY STATION

Combining circular and linear units, this design layout makes for the ideal make-your-own dish station that enhances the customer's experience.

(shown with optional Charcoal-Black quick covers)

MG CMSA02 **GSXF**



PRO SALSA BAR STATION

This station provides chefs with a perfect combination of a stainless steel workspace with extra storage and display areas to impress their diners.

(shown with optional Charcoal-Black quick covers)

MG CMLA02 **MSXW**



BAZAAR ACTION STATION MG CMLA03 GSWW
(shown with optional Silver-Grey quick covers)



SMALL S BUFFET MG CMSB03 GSXW
 (shown with optional Large Oval high display shelf and Small Oval low display shelf)



BUFFET STATIONS

As a fundamental functional element to any F&B operation, we believe Buffet Stations no longer need to be hidden under heavy linens nor lifted by the staff.

Mogogo takes an innovative and sustainable approach to Buffet Stations by introducing new design and functionality for linenless F&B Furniture, revealing beautiful clean lines. The presentation of a station is just as important as the quality of food being served and Mogogo offers ideal solutions for Chefs to display their most exquisite dishes. From Classic to Creative, Mogogo Buffet Stations offer a wide range of display and self-service options. Above, add shelves to elevate the dining experience of your guests; below, add our Quick Covers to conceal extra storage space.

Maximize every corner of your catering space by mixing and matching between our Classic Range and Creative Range to reinvent the experience of self-service in events.

MATERIAL GUIDE

Customize your Modular Stations by choosing from the different colors and finishes available.

Simply choose your preferred design combination by inserting the corresponding letter to its designated space as demonstrated below.

Item code: MG C#####

Design combination: TOP SEGMENT TEXTILE BASE

TOP	SEGMENT	TEXTILE	BASE

* High-Density Bamboo finish only available in North America

* High Density Bamboo

EXAMPLE:

MG CMLB10 GBWF =



COOLING CORNER STATION

Make the best use of space with this classic corner buffet station that gives all the advantages of a Mogogo station without taking up extra event space.
(shown with optional Golden-Brown quick covers)

MG CMLB01 BSXW



SELF SERVICE CHILLED SALAD STATION

Make a statement in any event with a chilled food station equipped with insulated ice bins and protective self-service high breath guards.
(shown with optional Silver-Grey quick covers)

MG CMLB03 GSXW



CLASSIC CURVED BUFFET STATION

This unique double-sided streamlined display station is not only beautiful but functional as well, designed to serve large crowds.
(shown with optional Silver-Grey quick covers)

MG CMLB02 MBXW



BREAD AND PASTRY STATION

Create a focal point in any event with this extra high buffet station, giving more storage and presentation area than ever before.
(shown with optional Golden-Brown quick covers)

MG CMLB04 WSXF

MATERIAL GUIDE

Customize your Modular Stations by choosing from the different colors and finishes available.

Simply choose your preferred design combination by inserting the corresponding letter to its designated space as demonstrated below.

Item code: MG C#####

Design combination: TOP SEGMENT TEXTILE BASE

TOP	SEGMENT	TEXTILE	BASE

* High-Density Bamboo finish only available in North America

* High Density Bamboo

EXAMPLE:

MG CMLB10 GBWF =



MARKET SQUARE

The classic look and feel of a traditional market with a modern flair gives this configuration all the functionality and practicality a large buffet station needs.

MG CMLB07 WBXF



ROUND MARKET

Acting not only as the event's focal point, this 360-degree buffet experience will also prevent chaotic queues.

MG CMSB01 MSXF



MULTI HEIGHT DISPLAY STATION

Create unforgettable events with this eye-catching display station, scattered with interchangeable display shelves in different heights. (shown with optional Charcoal-Black quick covers)

MG CMLB08 MBXF



MEDIUM S BUFFET

Avoid hectic buffet lines with Mogogo's Creative S station which gives a smooth crowd flow in any event.

MG CMSB02 GSXF



ALL STAINLESS PRO BAR MG CMLC06 MSXW
 (shown with optional Charcoal-Black quick covers)



BAR STATIONS

Redefine guests' expectations in any F&B operation by elevating their drink and beverage standards. From classic wine bars to mixology & curated cocktails - Bar Stations across your venue are an opportunity to make a statement.

Mogogo's Bar Station Collection features highly adaptable stations that can be used in a wide range of event types and sizes. Easily transportable from one venue to another thanks to their heavy-duty casters, Mogogo Bar Stations combine sleek design and high functionality.

Customize your station with our versatile Add-Ons and quickly conceal bottom shelves for additional storage with our Quick-Covers.

Everything in foodservice, for guests or chefs, is about the experience. Mogogo Bar Stations deliver on the promise of innovative functional design.

MATERIAL GUIDE

Customize your Modular Stations by choosing from the different colors and finishes available.

Simply choose your preferred design combination by inserting the corresponding letter to its designated space as demonstrated below.

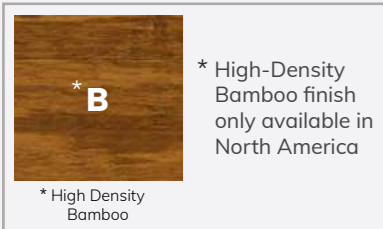
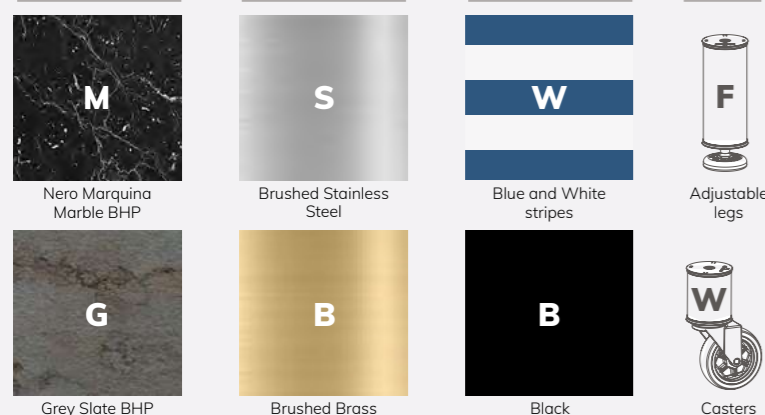
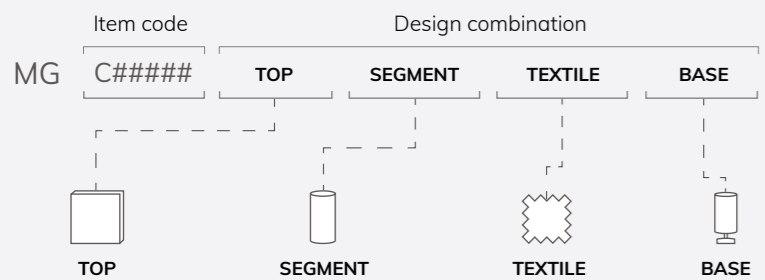

EXAMPLE:
MG CMLB10 **GBWF** =



PRO BAR & BACK BAR STATIONS

The Pro Bar is equipped with a stainless steel working surface, ice bin and speed-rail. Combined with a Mogogo Pro Back Bar, it's a bartender's dream. (shown with optional Silver-Grey quick covers)

PRO BAR MG CMLC05 WSXW

PRO BACK BAR MG CMLC01 WSXW



ALL STAINLESS PRO BAR & BACK BAR STATIONS

Mogogo's classic Pro and Back Bars get an updated look with all stainless tops for an extra professional look and feel. (shown with optional Charcoal-Black quick covers)

ALL STAINLESS PRO BAR MG CMLC06 MSXW

ALL STAINLESS PRO BACK BAR MG CMLC03 MSXW



MIXOLOGY BAR STATION

Designed to accommodate the most sophisticated Mixologists, this is the ultimate design element for a show-stopping cocktail mixing experience. (shown with optional Charcoal-Black quick covers)

MG CMLC07 GSBW



DOUBLE BAR STATION

The Double Bar allows serving beverages to guests anytime, anywhere. This portable yet classy design does it all. (shown with optional Golden-Brown quick covers)

MG CMLC11 BBXF

DAY & NIGHT

Modular stations can perfectly display breakfast buffets or help entertain guests at the next cocktail party.



CLASSIC PLUS MG CMLB13 WSXW
(shown with optional Golden-Brown quick cover)



PRO BAR MG CMLC05 MSXW
(shown with optional Silver-Grey quick covers)



STREAMLINE ARCH INDUCTION STATION MG CMLD05 MSXW
 (shown with optional Charcoal-Black quick covers and the Blackboard Collection)

WARMING AND COOKING STATIONS

The visual appeal of the colors and textures of the food, the aroma as it is prepared, and the sounds of sizzling pans... Cooking and Warming Stations generate excitement, curiosity, and can be a great catalyst for social interaction.

Now, Cooking and Warming Stations are redesigned as one modern and beautifully crafted element to seamlessly blend with your hospitality design standards. Designed as a modular extension to our existing function-based tabletops, Mogogo Cooking and Warming Stations offer your chefs high-functionality, mobility, and add a sense of theater for a special catering experience.

Your guests want creativity and variety. Introduce them to new culinary territories and let them discover new sensations with Mogogo's Cooking and Warming Stations.

MATERIAL GUIDE

Customize your Modular Stations by choosing from the different colors and finishes available.

Simply choose your preferred design combination by inserting the corresponding letter to its designated space as demonstrated below.

Item code	Design combination			
MG C#####	TOP	SEGMENT	TEXTILE	BASE
M Nero Marquina Marble BHP	S Brushed Stainless Steel	W Blue and White stripes	F Adjustable legs	
G Grey Slate BHP	B Brushed Brass	B Black	W Casters	
W Bengali Mango Wood BHP				
*B * High Density Bamboo * High Density Bamboo				

EXAMPLE:

MG CMLB10 GBWF =

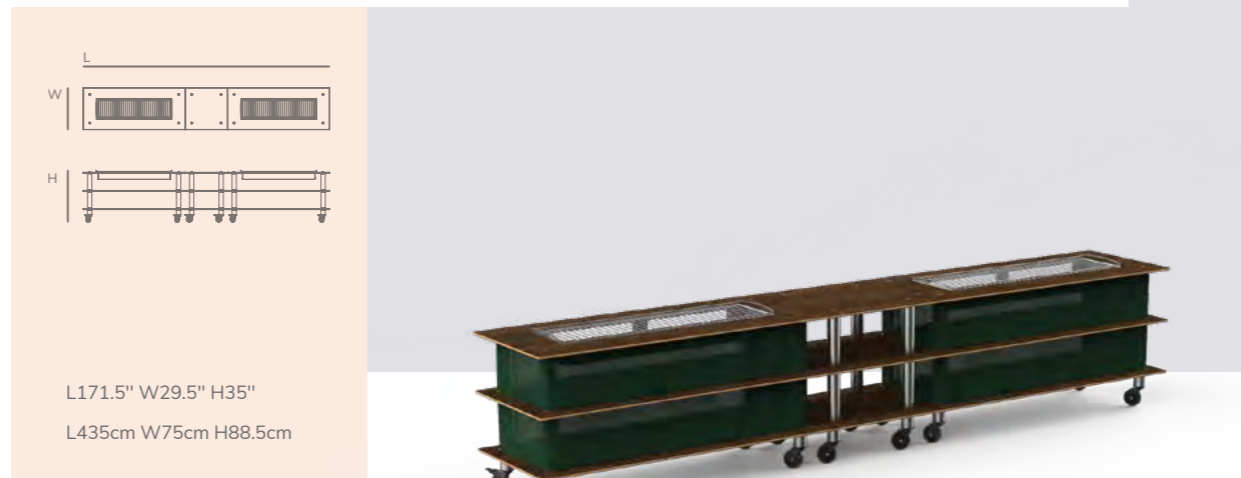

DOUBLE HEAT BUFFET TABLE

No need for a plug. This station uses canned heat to keep food warm during entire events.

(shown with optional Jungle-Green quick covers)

MG CMLD04 WSXW

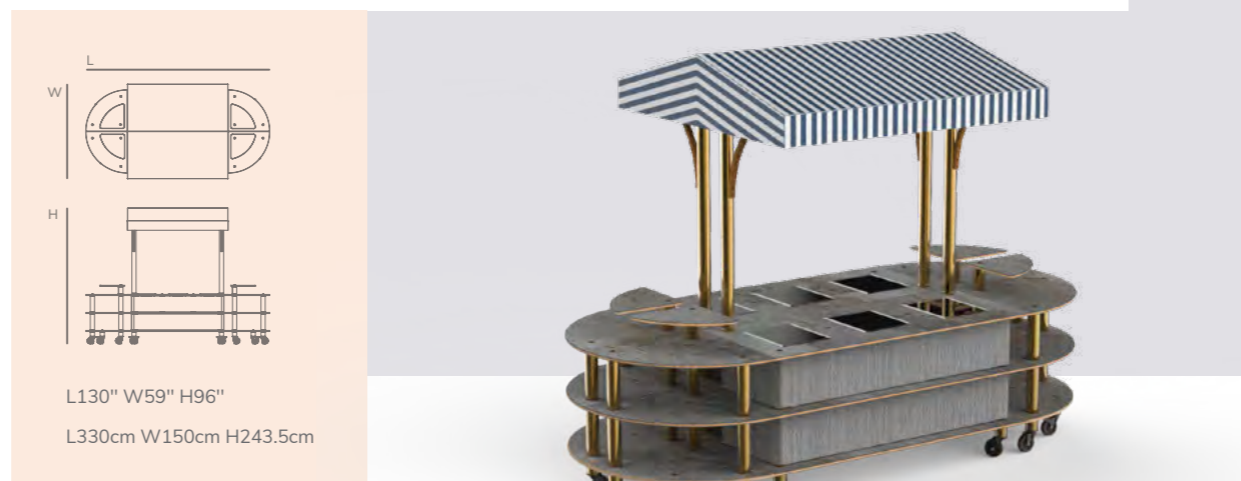

ROUNDED WARMING INDUCTION MARKET STATION

This stand-out station makes serving large crowds easy while keeping food warm on six drop-in induction units.

(shown with optional Silver-Grey quick covers)

MG CMLD03 GBWW



PRO COOKING INDUCTION

Drop-in cooking induction ranges give the freedom to bring a kitchen atmosphere within an event space for unique interactions with guests.

(shown with optional Charcoal-Black quick covers)

MG CMLD01 MSXW



LARGE ARCH INDUCTION STATION

Combining drop-in induction ranges with additional space for mise en place; the ultimate comfort for chefs.

(shown with optional Golden-Brown quick covers and Long Blackboard)

MG CMLD02 BSXW



HEAT TABLE MG CMLD06 WSXW
(shown with optional Golden-Brown quick covers)

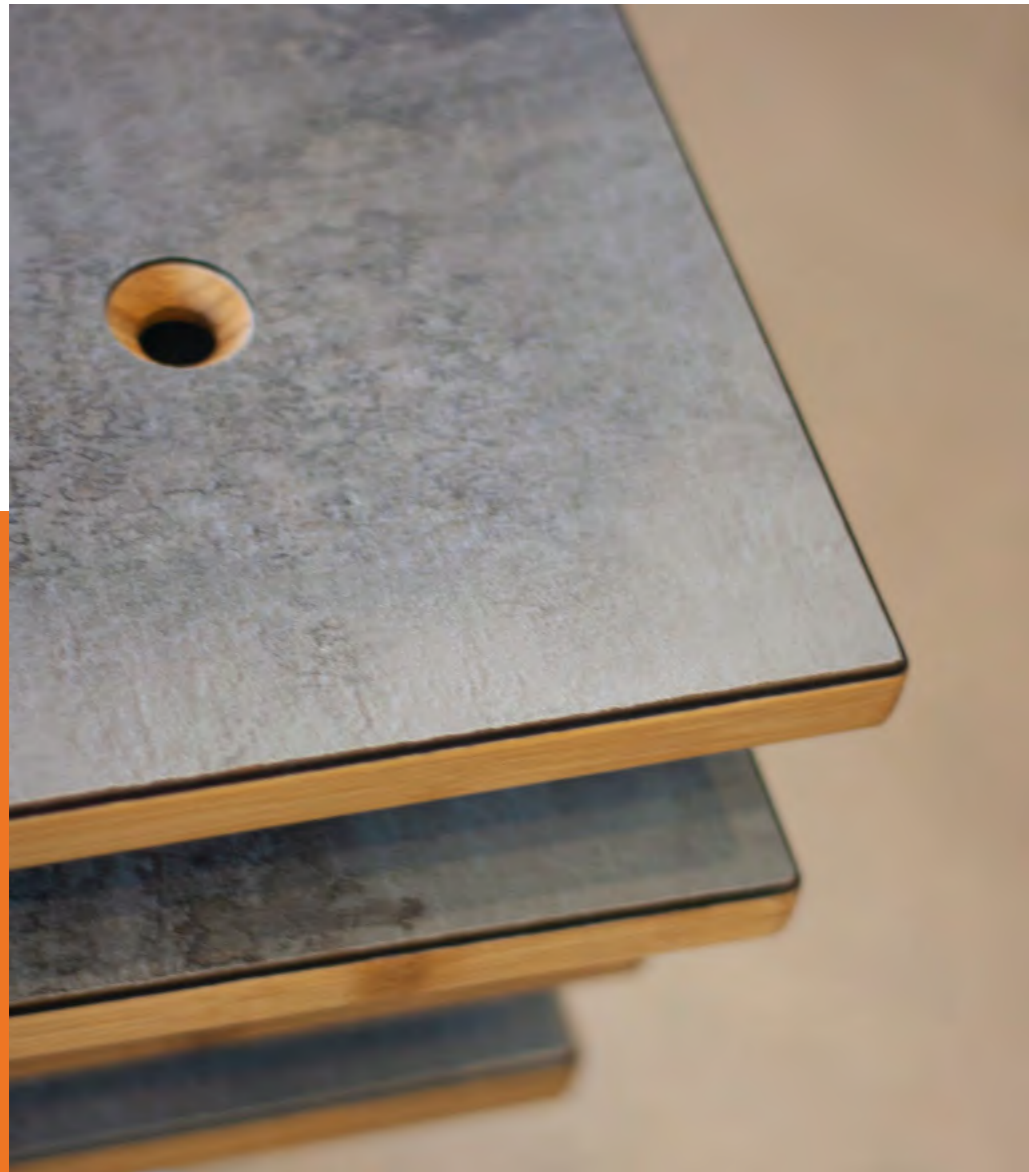

TRANSFER & STORAGE CARTS

Designed for convenience and mobility, Mogogo's utility carts are an integral part of the Modular system as they make storing and assembling the stations an easy task. Whether it is to push them through the halls, or get in and out of elevators, they make the behind the scenes of your time-sensitive events easier and give you an extra push on productivity.

The carts can store up to five large Classic units or four large Creative units while the orange vinyl coated areas ensure comprehensive tabletop protection.

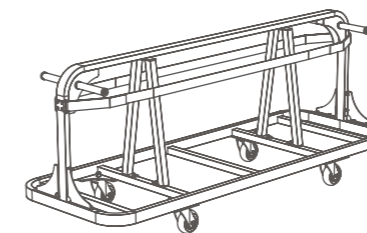

**LARGE PLATE
TRANSFER AND STORAGE CART**
L86.5" W31" H36.5"
L220cm W79cm H92.5cm
holds up to 18 tabletops

MG CUUX03 XXXX



**SEGMENTS AND ADD-ONS
TRANSFER AND STORAGE CART**
L55.5" W31" H50"
L141cm W79cm H127.5cm
holds 7-9 modular unit segments and legs/casters
+ dedicated storage space for multiple modular add-ons

MG CUUX01 XXXX



71" BREATH GUARD MG CIAN01 XSXX











SYSTEM BREAKDOWN

Mogogo's Modular System is based on a wide range of individual parts, which can be stacked up & assembled to design a variety of stations.

Our Modular System stems from the simple idea that your F&B Furniture should adapt to your ever-varying needs during different event sizes, types, and themes. It allows you to pick and choose basic elements such as tabletops, leg segments, casters, shelves, and other add-ons.

Endless vertical and horizontal possibilities exist while choosing between our functional tabletops: from classic to cooking, warming and bar tabletops, or picking your material and finishes of choice. Mogogo's Modular System gifts you an ocean of possibilities.

MOGOGO TOOLS

	1 piece	ALLEN KEY FOR M16	MG SAUXSS 0101
	1 piece	M16 SCREWS	MG SSCWMT 0101
 	1 piece	BLACK SCREW CAP	MG SSACPL 0601
 	1 piece	GREY SCREW CAP	MG SSACPL 0501
 	1 piece	BROWN SCREW CAP	MG SSACPI 0201
 X1  X2  X12		UTILITY KIT: ALLEN KEY FOR M16 2 M16 SCREWS 12 SCREW CAPS (4 Screw caps X 3 colors)	MG SSACSM 0102







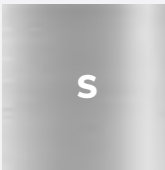

MATERIAL GUIDE

Customize your Modular Stations by choosing from the different colors and finishes available.

Simply choose your preferred design combination by inserting the corresponding letter to its designated space as demonstrated below.

Item code: MG C#####

Design combination: TOP SEGMENT TEXTILE BASE

TOP	SEGMENT	TEXTILE	BASE
 M Nero Marquina Marble BHP	 S Brushed Stainless Steel	 W Blue and White stripes	 F Adjustable legs
 G Grey Slate BHP	 B Brushed Brass	 B Black	 W Casters
 W Bengali Mango Wood BHP	* High-Density Bamboo finish only available in North America		
* High Density Bamboo			

EXAMPLE:
MG CMLB10 GBWF =



CREATIVE RANGE

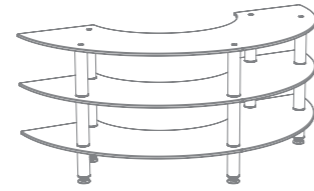

CREATIVE CURVED UNIT
L81.5" W41" H35"
L207cm W104cm H88.5cm

MG CMSX01 __ X _

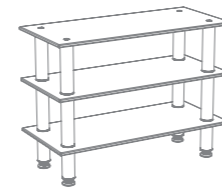

CREATIVE EXTENSION UNIT
L47" W21" H35"
L120cm W54cm H88.5cm

MG CMSX02 __ X _

CLASSIC RANGE

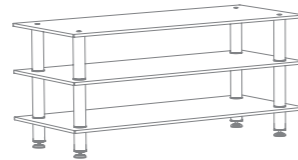

CLASSIC LARGE UNIT
L71" W29.5" H35"
L180cm W75cm H88.5cm

MG CMLX01 __ X _



CLASSIC MEDIUM UNIT
L47" W29.5" H35"
L120cm W75cm H88.5cm

MG CMLX02 __ X _

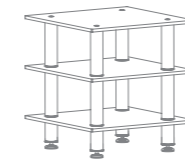

CLASSIC SMALL UNIT
L29.5" W29.5" H35"
L75cm W75cm H88.5cm

MG CMLX03 __ X _

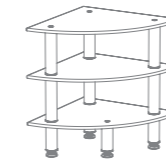

CLASSIC CORNER UNIT
L29.5" W29.5" H35"
L75cm W75cm H88.5cm

MG CMLX04 __ X _

STANDARD RANGE

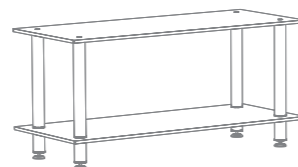

STANDARD LARGE UNIT
L71" W29.5" H35"
L180cm W75cm H88.5cm

MG CMDX01 __ X _

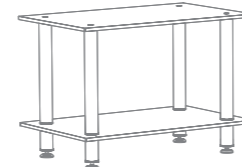

STANDARD MEDIUM UNIT
L47" W29.5" H35"
L120cm W75cm H88.5cm

MG CMDX02 __ X _

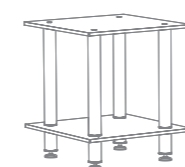

STANDARD SMALL UNIT
L29.5" W29.5" H35"
L75cm W75cm H88.5cm

MG CMDX03 __ X _

CREATIVE RANGE SHELVES

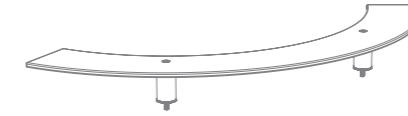

CURVED OUTER SHELF
L76" W27.5" H6.5"
L193cm W70cm H16.5cm

MG CIAF01 __ XX



CURVED INNER SHELF
L53" W26.5" H6.5"
L135cm W68cm H16.5cm

MG CIAF02 __ XX



EXTENSION SHELF
L47" W10" H6.5"
L120cm W25cm H16.5cm

MG CIAF03 __ XX

CLASSIC RANGE SHELVES



LARGE SHELF
L71" W9.5" H12.5"
L180cm W24cm H32cm

MG CIAF04 __ XX

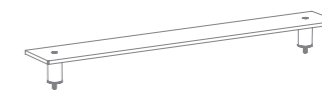

LARGE LOW SHELF
L71" W9.5" H6.5"
L180cm W24cm H16.5cm

MG CIAF05 __ XX



LARGE WIDE BAR SHELF
L71" W14.5" H12.5"
L180cm W37cm H32cm

MG CIAF06 __ XX



MEDIUM SHELF
L47" W9.5" H12.5"
L120cm W24cm H32cm

MG CIAF07 __ XX

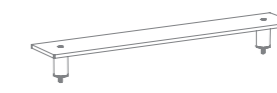

MEDIUM LOW SHELF
L47" W9.5" H6.5"
L120cm W24cm H16.5cm

MG CIAF08 __ XX

MATERIAL GUIDE

Customize your Modular Stations by choosing from the different colors and finishes available.

Simply choose your preferred design combination by inserting the corresponding letter to its designated space as demonstrated below.

Item code	Design combination			
MG C#####	TOP	SEGMENT	TEXTILE	BASE
	M	S	W	F
	Nero Marquina Marble BHP	Brushed Stainless Steel	Blue and White stripes	Adjustable legs
	G	B	B	W
	Grey Slate BHP	Brushed Brass	Black	Casters
	W			
	Bengali Mango Wood BHP			
	*B			
	* High-Density Bamboo finish only available in North America			
	* High Density Bamboo			

EXAMPLE:

MG CMLB10 **GBWF** =



CLASSIC RANGE DISPLAY SHELVES

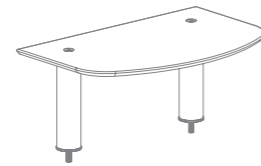

HIGH SIDE SHELF
L29.5" W19" H12.5"
L75cm W47.5cm H32cm

MG CIAY01 __ XX

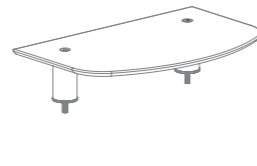

LOW SIDE SHELF
L29.5" W19" H6.5"
L75cm W47.5cm H16.5cm

MG CIAY02 __ XX

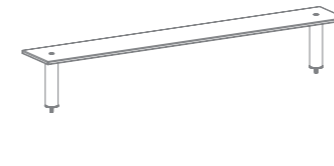

WIDE DISPLAY SHELF
L80" W12" H12.5"
L203cm W30.5cm H32cm
connects 2 mid-hole display tabletops

MG CIAY03 __ XX

DISPLAY SHELVES

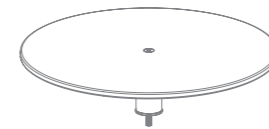

30" ROUND LOW DISPLAY SHELF
Ø30" H6.5"
Ø76cm H16.5cm

MG CIAY04 __ XX

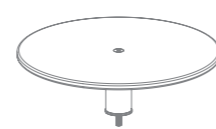

24" ROUND LOW DISPLAY SHELF
Ø24" H6.5"
Ø60cm H16.5cm

MG CIAY05 __ XX

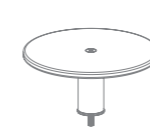

18" ROUND LOW DISPLAY SHELF
Ø18" H6.5"
Ø46cm H16.5cm

MG CIAY06 __ XX

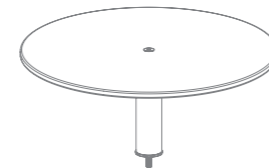

30" ROUND HIGH DISPLAY SHELF
Ø30" H12.5"
Ø76cm H32cm

MG CIAY07 __ XX

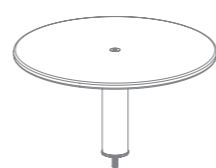

24" ROUND HIGH DISPLAY SHELF
Ø24" H12.5"
Ø60cm H32cm

MG CIAY08 __ XX

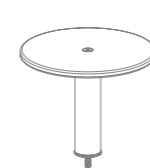

18" ROUND HIGH DISPLAY SHELF
Ø18" H12.5"
Ø46cm H32cm

MG CIAY09 __ XX

DISPLAY SHELVES

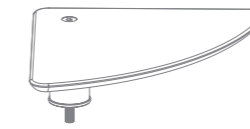

LARGE TRIANGLE LOW DISPLAY SHELF
L17" W17" H6.5"
L44cm W44cm H16.5cm

MG CIAY10 __ XX

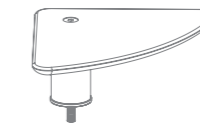

SMALL TRIANGLE LOW DISPLAY SHELF
L14" W14" H6.5"
L35cm W35cm H16.5cm

MG CIAY11 __ XX

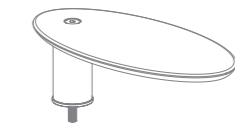

LARGE OVAL LOW DISPLAY SHELF
L20" W10" H6.5"
L50cm W25cm H16.5cm

MG CIAY14 __ XX

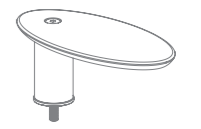

SMALL OVAL LOW DISPLAY SHELF
L16" W8" H6.5"
L40cm W20cm H16.5cm

MG CIAY15 __ XX

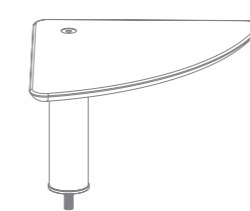

LARGE TRIANGLE HIGH DISPLAY SHELF
L17" W17" H12.5"
L44cm W44cm H32cm

MG CIAY12 __ XX

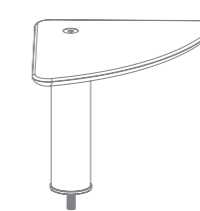

SMALL TRIANGLE HIGH DISPLAY SHELF
L14" W14" H12.5"
L35cm W35cm H32cm

MG CIAY13 __ XX

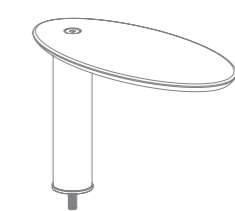

LARGE OVAL HIGH DISPLAY SHELF
L20" W10" H12.5"
L50cm W25cm H32cm

MG CIAY16 __ XX

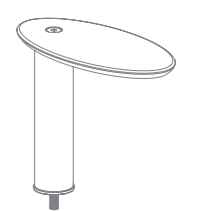

SMALL OVAL HIGH DISPLAY SHELF
L16" W8" H12.5"
L40cm W20cm H32cm

MG CIAY17 __ XX

MATERIAL GUIDE

Customize your Modular Stations by choosing from the different colors and finishes available.

Simply choose your preferred design combination by inserting the corresponding letter to its designated space as demonstrated below.

Item code: MG C#####

Design combination: TOP SEGMENT TEXTILE BASE

TOP	SEGMENT	TEXTILE	BASE
M Nero Marquina Marble BHP	S Brushed Stainless Steel	W Blue and White stripes	F Adjustable legs
G Grey Slate BHP	B Brushed Brass	B Black	W Casters
W Bengali Mango Wood BHP			
*B * High-Density Bamboo * High Density Bamboo			

EXAMPLE:
MG CMLB10 **GBWF** =



ADD-ONS

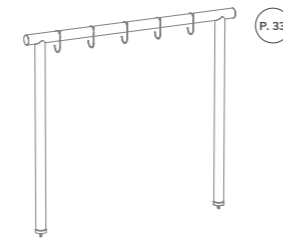

ARCH
L71" W3" H61"
L180cm W7.6cm H155cm
Fits large units

MG CIAM02 X_XX

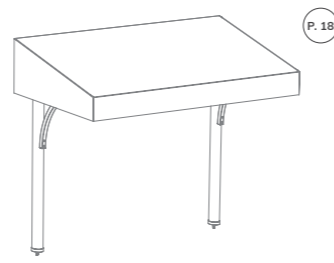

CANOPY
L71" W33.5" H61"
L180cm W85cm H155cm
Fits large units

MG CIAM03 X__X

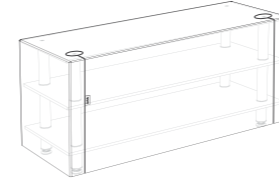

OUTDOOR CORDURA COVER
Fits classic large unit

MG SADDCR 0401

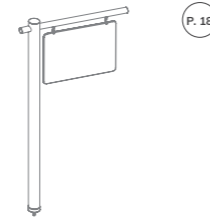

SIGN POST
L32" W3" H59"
L80.5cm W7.6cm H150cm
Fits all units

MG CIAM01 X_XX

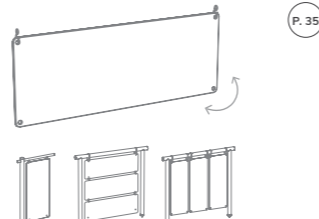

LONG BLACKBOARD
L47" H18"
L120cm H45cm
Fits Arch and Sign post

MG SADDSM 0201



BLACKBOARD COLLECTION
5X various shapes
Fits Arch

MG SADDSM 0301

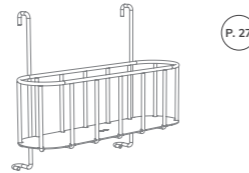

SPEEDRAIL
L18.5" W5" H14"
L47cm W13cm H36cm
Fits bar top

MG SADDSS 0602

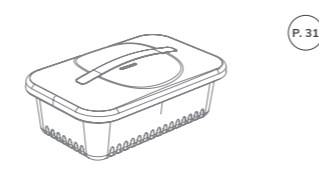

MOGOGO ICE BIN
L19.5" H12.5" W8"
L49.5cm H31cm W20cm
Fits Pro bar top

MG SADDPL 0301

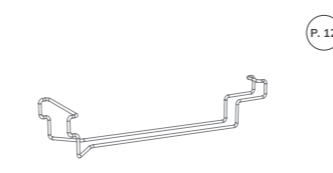

WINE GLASS HOLDER
L15" H2.5" W4.5"
L37.5cm H6.5cm W11cm
Fits Large wide bar shelf
Holds up to 6 wine glasses

MG SADDSS 1301

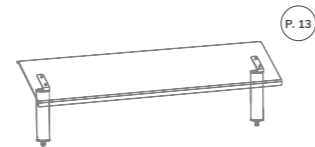

71" BREATH GUARD
H18.5" | gap H8.5"
H47cm | gap H22cm
Fits large units

MG CIAN01 X_XX

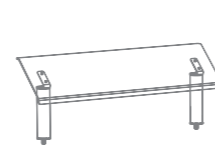

47" BREATH GUARD
H18.5" | gap H8.5"
H47cm | gap H22cm
Fits medium units

MG CIAN02 X_XX

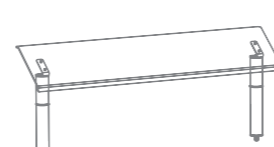

71" HIGH BREATH GUARD
H24.5" | gap H14"
H62cm | gap H36.5cm
Fits large units

MG CIAN03 X_XX

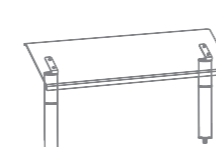

47" HIGH BREATH GUARD
H24.5" | gap H14"
H62cm | gap H36.5cm
Fits medium units

MG CIAN04 X_XX

QUICK COVERS

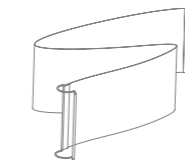

Fits Unit	Amount	Golden-Brown	Silver-Grey	Charcoal-Black	Jungle-Green
LARGE CLASSIC UNIT	2	MG SQCOPV 0301	MG SQCOPV 0401	MG SQCOPV 1601	MG SQCOGP 0201
MEDIUM CLASSIC UNIT	2	MG SQCOPV 0501	MG SQCOPV 0601	MG SQCOPV 1701	MG SQCOGP 0301
SMALL CLASSIC UNIT	2	MG SQCOPV 0701	MG SQCOPV 0801	MG SQCOPV 1801	MG SQCOGP 0401
CORNER CLASSIC UNIT	2	MG SQCOPV 2401	MG SQCOPV 2501	MG SQCOPV 2601	MG SQCOGP 1101
CURVED CREATIVE UNIT	2	MG SQCOPV 0901	MG SQCOPV 1001	MG SQCOPV 1901	MG SQCOGP 0501
EXTENSION CREATIVE UNIT	2	MG SQCOPV 1101	MG SQCOPV 1201	MG SQCOPV 2001	MG SQCOGP 0601
LARGE SHELF COVER	1	MG SQCOPV 0101	MG SQCOPV 0201	MG SQCOPV 1501	MG SQCOGP 0101

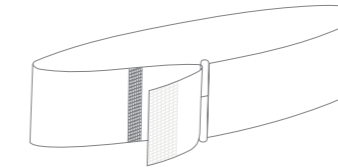

360° QUICK COVERS

LARGE CLASSIC UNIT	2	MG SQCOPV 3401	MG SQCOPV 3301	MG SQCOPV 3201	MG SQCOGP 0801
--------------------	---	----------------	----------------	----------------	----------------

SEGMENTS



Brushed Stainless Steel Brushed Brass



5.7" SEGMENT
H5.7" | H14cm
available in sets of:
1 / 2

1 piece	MG SLEGSS 0201	MG SLEGBR 0401
2 pcs	MG SLEGSS 0501	MG SLEGBR 0901



12" SEGMENT
H12" | H30cm
available in sets of:
1 / 2 / 8

1 piece	MG SLEGSS 0101	MG SLEGBR 0301
2 pcs	MG SLEGSS 0401	MG SLEGBR 0801
8 pcs	MG SLEGSS 1501	MG SLEGBR 1001



STANDARD SEGMENT
H25" | H63cm
available in sets of:
1 / 4

1 piece	MG SLEGSS 1701	MG SLEGBR 1401
4 pcs	MG SLEGSS 1801	MG SLEGBR 1501

LEGS

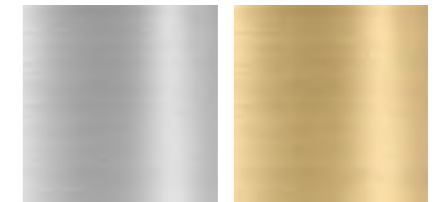

Brushed Stainless Steel Brushed Brass



ADJUSTABLE LEGS
available in sets of:
1 single leg / 4 legs

1 piece	MG SLEGSS 1301	MG SLEGBR 0101
4 pcs	MG SLEGSS 1401	MG SLEGBR 0201

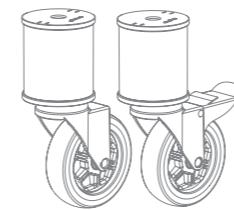

CASTERS
available in sets of:
1 with brake / without brake
4 casters (2 with brakes and 2 without)

1 piece with brake	MG SADDSS 0404	MG SADDBR 0604
1 piece without brake	MG SADDSS 0304	MG SADDBR 0504
4 pcs	MG SADDSS 0104	MG SADDBR 0404

CLASSIC RANGE TABLETOPS



* High density Bamboo

Bengali Mango Wood BHP

Grey Slate BHP

Nero Marquina Marble BHP



MG SCTPBM 0102 MG SCTPHW 0101 MG SCTPHG 0101 MG SCTPHB 0101

LARGE RECTANGLE TOP
L71" W29.5"
L180cm W75cm



MG SCTPBM 0202 MG SCTPHW 0201 MG SCTPHG 0201 MG SCTPHB 0201

MEDIUM RECTANGLE TOP
L47" W29.5"
L120cm W75cm

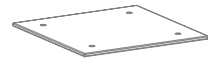

MG SCTPBM 0302 MG SCTPHW 0301 MG SCTPHG 0301 MG SCTPHB 0301

SMALL SQUARE TOP
L29.5" W29.5"
L75cm W75cm

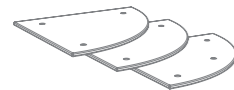

MG CILX01 BXXX MG CILX01 WXXX MG CILX01 GXXX MG CILX01 MXXX

CORNER UNIT TOP SET
L29.5" W29.5"
L75cm W75cm

CLASSIC RANGE SHELF TOPS



* High density Bamboo

Bengali Mango Wood BHP

Grey Slate BHP

Nero Marquina Marble BHP



MG SCLSBM 0202 MG SCLSHW 0201 MG SCLSHG 0201 MG SCLSHB 0201

LARGE WIDE BAR SHELF
L71" W14.5"
L180cm W37cm



MG SCLSBM 0102 MG SCLSHW 0101 MG SCLSHG 0101 MG SCLSHB 0101

LARGE SHELF
L71" W9.5"
L180cm W24cm



MG SCLSBM 0302 MG SCLSHW 0301 MG SCLSHG 0301 MG SCLSHB 0301

MEDIUM SHELF
L47" W9.5"
L120cm W24cm

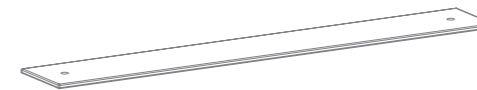

MG SSTPBM 0101 MG SCLSHW 0501 MG SCLSHG 0501 MG SCLSHB 0501

WIDE DISPLAY SHELF
L80" W12"
L203cm W30.5cm
connects 2 mid-hole display tabletops



MG SCSVBM 0501 MG SCLSHW 0801 MG SCLSHG 0801 MG SCLSHB 0801

SIDE SHELF
L29.5" W19"
L75cm W47.5cm

CREATIVE RANGE TABLETOPS

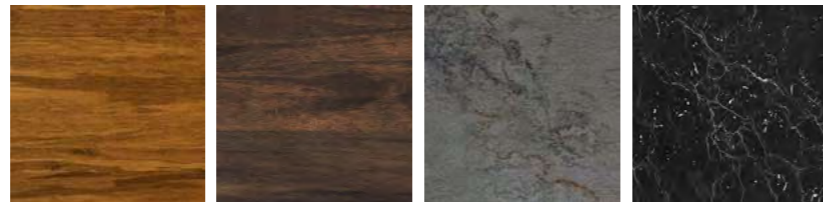

* High density Bamboo Bengali Mango Wood BHP Grey Slate BHP Nero Marquina Marble BHP



MG SCTBBM 0101 MG SCTBHW 0101 MG SCTBHG 0101 MG SCTBHB 0101

LARGE ROUND TOP
L81.5" W41"
L207cm W104cm



MG SCTBBM 0201 MG SCTBHW 0201 MG SCTBHG 0201 MG SCTBHB 0201

47" EXTENSION TOP
L47" W21"
L120cm W54cm

CREATIVE RANGE SHELF TOPS



MG SCSVBM 0101 MG SCSVHW 0101 MG SCSVHG 0101 MG SCSVHB 0101

CURVED OUTER SHELF
L76" W27.5"
L193cm W70cm



MG SCSVBM 0201 MG SCSVHW 0201 MG SCSVHG 0201 MG SCSVHB 0201

CURVED INNER SHELF
L53" W26.5"
L135cm W68cm



MG SCLSBM 0401 MG SCSVHW 0801 MG SCSVHG 0801 MG SCSVHB 0801

EXTENSION SHELF
L47" W10"
L120cm W25cm

DISPLAY SHELF TOPS FOR CLASSIC AND CREATIVE RANGE

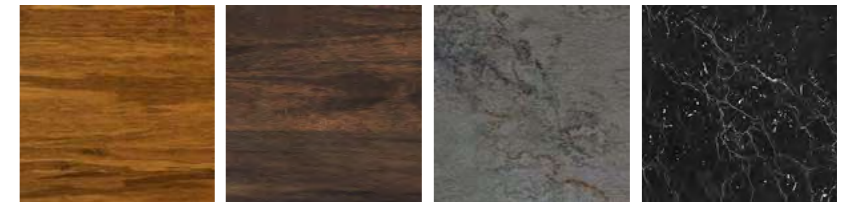

* High density Bamboo Bengali Mango Wood BHP Grey Slate BHP Nero Marquina Marble BHP

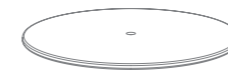

MG SCRTBM 0102 MG SCRTHW 0101 MG SCRTHG 0101 MG SCRTHB 0101

30" ROUND TOP
Ø30" | Ø76cm



MG SCRTBM 0202 MG SCRTHW 0201 MG SCRTHG 0201 MG SCRTHB 0201

24" ROUND TOP
Ø24" | Ø60cm

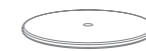

MG SCRTBM 0302 MG SCRTHW 0301 MG SCRTHG 0301 MG SCRTHB 0301

18" ROUND TOP
Ø18" | Ø46cm



MG SCSVBM 0601 MG SCLSHW 0601 MG SCLSHG 0601 MG SCLSHB 0601

LARGE TRIANGLE DISPLAY SHELF
L17" W17" | L44cm W44cm



MG SCSVBM 0701 MG SCLSHW 0701 MG SCLSHG 0701 MG SCLSHB 0701

SMALL TRIANGLE DISPLAY SHELF
L14" W14" | L35cm W35cm



MG SCSVBM 0301 MG SSLFHW 0301 MG SSLFHG 0301 MG SSLFHB 0301

LARGE OVAL DISPLAY SHELF
L20" W10" | L50cm W25cm



MG SCSVBM 0401 MG SSLFHW 0401 MG SSLFHG 0401 MG SSLFHB 0401

SMALL OVAL DISPLAY SHELF
L16" W8" | L40cm W20cm

MATERIAL GUIDE

Customize your Modular Stations by choosing from the different colors and finishes available.

Simply choose your preferred design combination by inserting the corresponding letter to its designated space as demonstrated below.

Item code	Design combination			
MG C#####	TOP	SEGMENT	TEXTILE	BASE
	M	S	W	F
	Nero Marquina Marble BHP	Brushed Stainless Steel	Blue and White stripes	Adjustable legs
	G	B	B	W
	Grey Slate BHP	Brushed Brass	Black	Casters
	W			
	Bengali Mango Wood BHP			
	*B			
	* High-Density Bamboo finish only available in North America			
	* High Density Bamboo			

EXAMPLE:

MG CMLB10 **GBWF** =



CLASSIC RANGE STAINLESS STEEL SPECIAL TABLETOPS KITS



Brushed Stainless Steel

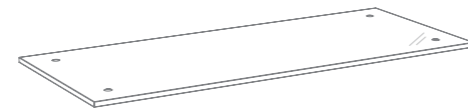

STAINLESS STEEL TOP
L71" W29.5"
L180cm W75cm

MG SSTPSS 0301

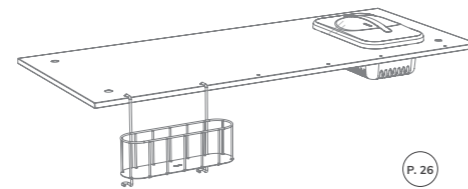

PRO BAR TOP
L71" W29.5" | L180cm W75cm
Ice Bin: L16" W9" D6"
L41.5cm W23cm D15cm

MG CITC01 SXXX



SALAD-BAR TOP
L71" W29.5" | L180cm W75cm
Ice Cooler: L48" W25" D6.5"
L122cm W63cm D16cm

MG CITE01 SXXX

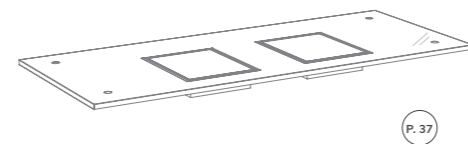

COOKING DROP-IN TOP
L71" W29.5"
L180cm W75cm

MG CITD01 SXXX

CLASSIC RANGE STAINLESS STEEL SPECIAL TABLETOP UNITS

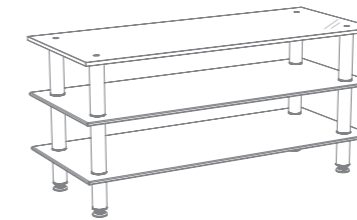

LARGE PRO UNIT
L71" W29.5" H35"
L180cm W75cm H88.5cm

MG CMLA05 _ _ X _

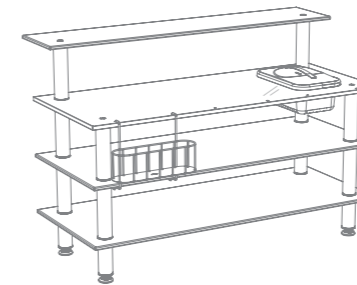

PRO BAR
L71" W29.5" H47.5"
L180cm W75cm H121cm

MG CMLC05 _ _ X _

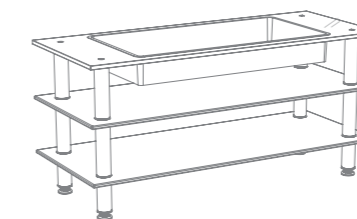

SALAD-BAR UNIT
L71" W29.5" H35"
L180cm W75cm H88.5cm

MG CMLE03 _ _ X _

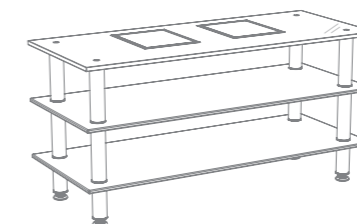

PRO COOKING INDUCTION
L71" W29.5" H35"
L180cm W75cm H88.5cm

MG CMLD01 _ _ X _









MATERIAL GUIDE

Customize your Modular Stations by choosing from the different colors and finishes available.

Simply choose your preferred design combination by inserting the corresponding letter to its designated space as demonstrated below.

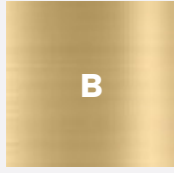
Item code: MG C#####

Design combination: TOP SEGMENT TEXTILE BASE

TOP	SEGMENT	TEXTILE	BASE
 M Nero Marquina Marble BHP	 S Brushed Stainless Steel	 W Blue and White stripes	 F Adjustable legs
 G Grey Slate BHP	 B Brushed Brass	 B Black	 W Casters
 W Bengali Mango Wood BHP	 * B * High-Density Bamboo finish only available in North America * High Density Bamboo		

EXAMPLE:

MG CMLB10 GBWF =



CLASSIC RANGE SPECIAL TABLETOP KITS

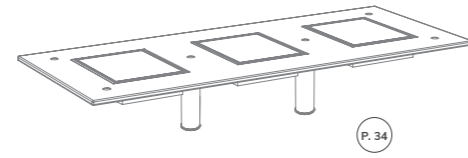

WARMING TRIPLE DROP-IN TOP
L71" W29.5" | L180cm W75cm
Comes with 2 x 12" support segment

MG CITD02 _ _ XX

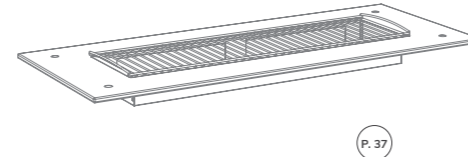

HEAT TABLETOP
L71" W29.5" | L180cm W75cm
Grill: L48" W25" D6.5"
L122cm W63cm D16cm

MG CITD04 _ XXX

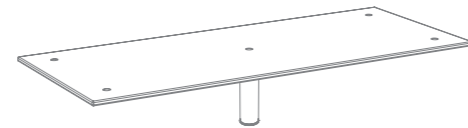

MID-HOLE DISPLAY TABLETOP
L71" W29.5" | L180cm W75cm
Comes with 1 x 12" support segment

MG CITB01 _ _ XX

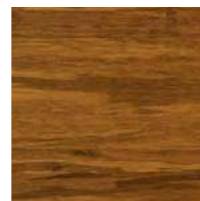

High Density Bamboo

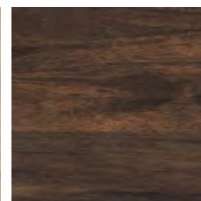

Bengali Mango Wood BHP



Grey Slate BHP

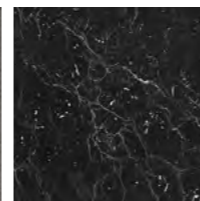

Nero Marquina Marble BHP

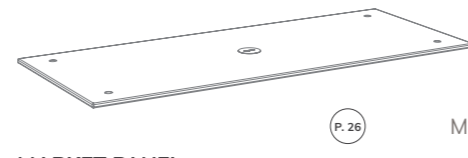

MARKET PANEL
(Only for Market Square)
L71" W29.5" | L180cm W75cm

MG SSTPBM 0503

MG SSTPHW 0501

MG SSTPHG 0501

MG SSTPHB 0501

CLASSIC RANGE SPECIAL TABLETOP UNITS

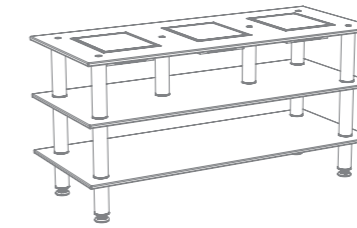

TRIPLE WARMING UNIT
L71" W29.5" H35"
L180cm W75cm H88.5cm

MG CMLD07 _ _ X _

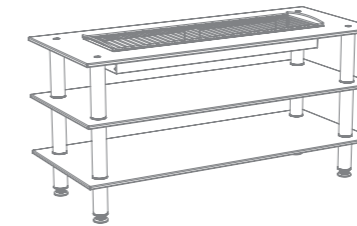

HEAT TABLE
L71" W29.5" H35"
L180cm W75cm H88.5cm

MG CMLD06 _ _ X _

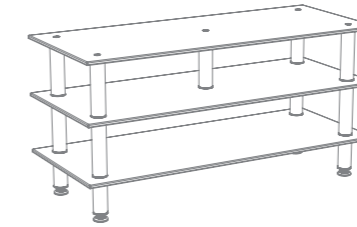

MID-HOLE DISPLAY UNIT
L71" W29.5" H35"
L180cm W75cm H88.5cm

MG CMLB09 _ _ X _

mogogo
BUFFET SOLUTIONS



ROLLIN
SERVICE CARTS

2022/2023

DISTRIBUTED BY:  steelite
INTERNATIONAL



SERVICE CART MG CRNX01 MSXX \ \ MG CRNX01 GSXX
(shown with optional Charcoal-Black quick covers)

INDEX

 New Products

 Bartender

 Waiter

 See Page



A PROFESSIONAL
FOOD & BEVERAGE
FURNITURE COMPANY

BORN FROM AN INTERDISCIPLINARY PASSION FOR **Design x Food**



Mogogo is led by designers and chefs that are driven by the desire to introduce new, beautiful, and functional products to the market, with an environmentally friendly philosophy in mind.

WE PUSH
THE CREATIVE ENVELOPE
OF FUNCTION AND INNOVATION.



LINENLESS



MODULAR



MOBILE



SUSTAINABLE



ADD ONS



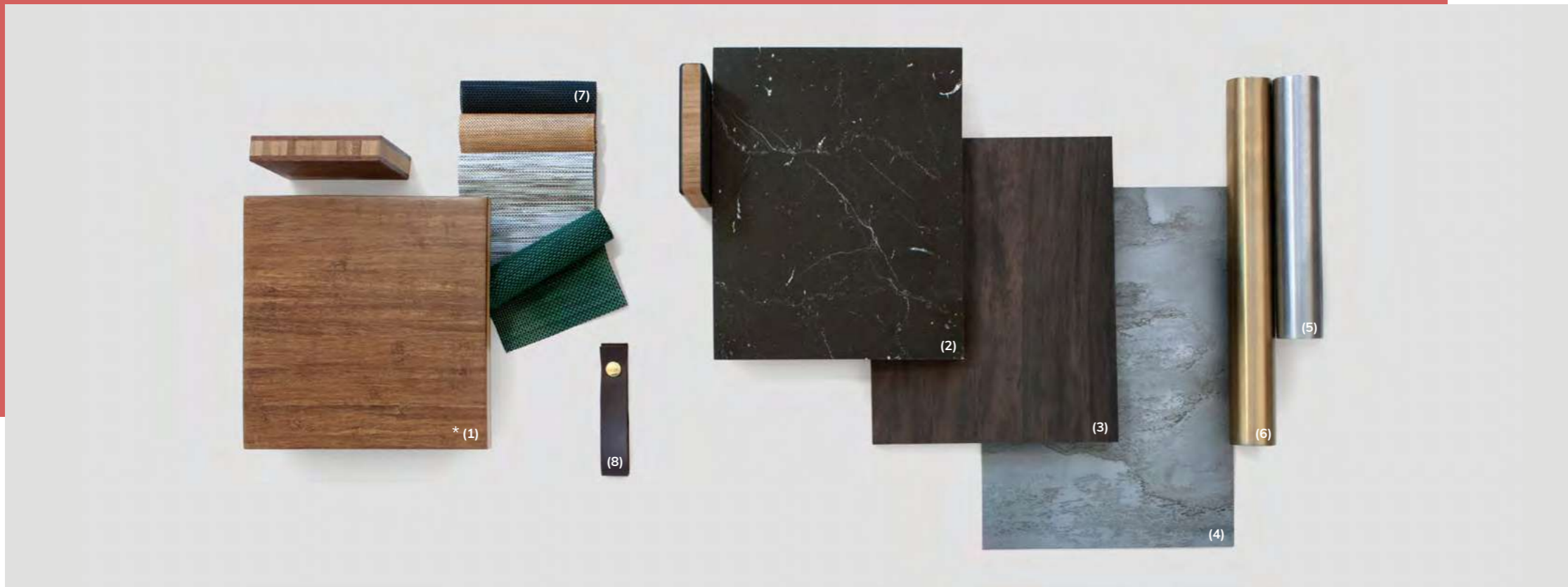

ABOUT ROLL'N COLLECTION

Tableside Service is considered an exquisite service in the hospitality industry. A smaller unit on wheels with a sleek design is the ideal serving sidekick for your staff in any dining environment. Just like everything designed by Mogogo, the Roll'n Service Cart collection starts with a core element. It's an elegant and functional cart with high-density BHP panels, heavy-duty casters, and a slick leather covered handle for easier and more comfortable navigation. From there, Mogogo's designers developed a series of add-ons that can easily transform your service cart into a cheese serving cart, cocktail cart, and much more.

MATERIALS

Joining our Bamboo (1)* collection is our new innovative BHP material. BHP is a newly composed material that arrived after two years of intense R&D. It merges layers of High-Pressure Laminate with a Vertical Bamboo core (Mogogo's expertise) creating a lighter yet durable panel that offers new textures and colors. This new material combines the advantages of both bamboo and HPL, perfect for the ever-changing needs of the hospitality industry. Available in a variety of finishes that resemble natural materials such as Nero Marquina Marble, Bengali Mango Wood, and Grey Slate (2-4), making it easy to match with any event and decor.

The innovative bamboo core of the BHP goes in line with Mogogo's sustainability motto while the HPL's outer coating is durable for different environments, hygienic, and easy to clean.

Roll'n segments come in 2 finishes: brushed stainless steel (5) and brushed brass (6).

Easily cover up parts of your service carts with our original quick covers (7). Both durable and easy to clean, they come in 4 different color options allowing you to easily match any of your event color schemes.

All service carts come with a hand-stitched leather (8) handle which gives the carts a luxurious look and a comfortable functionality.

HOW IT WORKS

Delivered to you in flat packaging with all the needed parts, Roll'n Service Cart is specially designed for easy and fast assembly.

With a multi-purpose cart in mind, Mogogo's Service Cart was developed alongside a series of add-ons which can easily transform your standard service cart into a cheese serving cart, wine cart, cocktail cart, and more for any tableside service occasion. Add or remove Mogogo's add-ons, such as a cutting board, top rail border, wine glass holder, or ice and champagne bucket depending on your specific food service delivery need.

Functionality is key when it comes to the daily challenges of Food & Beverage professionals. For this specific reason, Mogogo's quick-covers are essential to quickly conceal the two lower layers for dishes or additional items you would like to hide from your guests in the most elegant way.

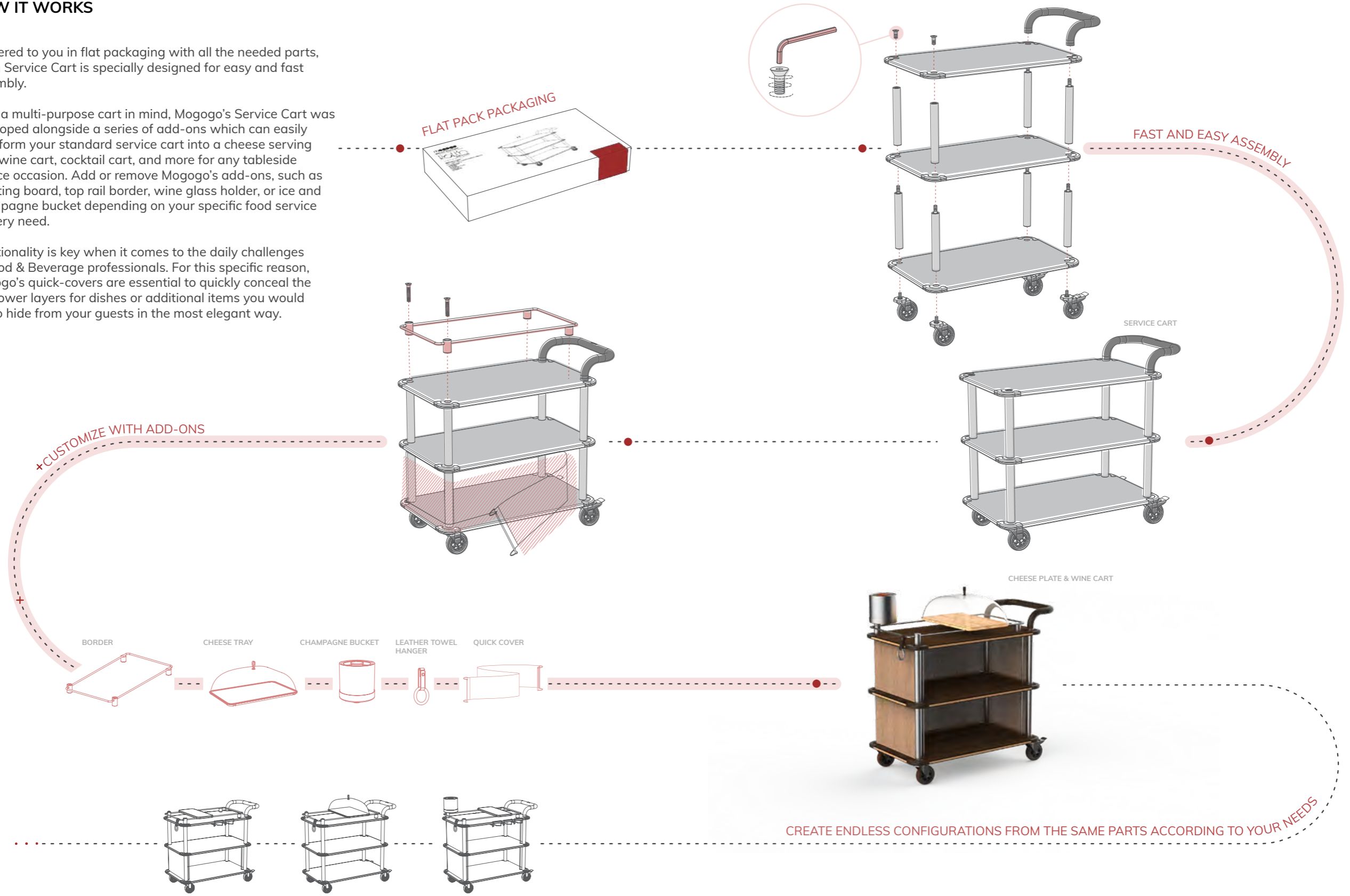



MG CRNX04 WBXX (shown with optional quick covers)



MG CRNX01 GBXX



COLOR COMBINATIONS



MG CRNX03 MBXX (shown with optional quick cover)

With the different finishes, color combinations, and add-ons, you can easily change the vibe and take your service carts to a whole new level



MG CRNX04 GSXX (shown with optional quick covers)



*
While the brass has a more elegant look the stainless gives off a more modern one
.All combinations are possible









MG CRNX01 MSXX (shown with optional quick covers)



MATERIAL GUIDE

Customize your Roll'n Service Carts by choosing from the different colors and finishes available. Simply choose your preferred design combination by inserting the corresponding letter to its designated space as demonstrated below.

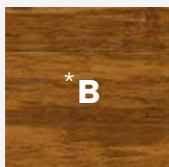
Item code	Design combination	
MG C#####	TOP	SEGMENT XX
		
	TOP	SEGMENT
		
	M Nero Marquina Marble BHP	S Brushed Stainless Steel
		
	G Grey Slate BHP	B Brushed Brass
		
	W Bengali Mango Wood BHP	
		
	*B * High-Density Bamboo finish only available in North America	
	<small>* High density Bamboo</small>	

EXAMPLE:
MG CRNX01 MSXX =



SERVICE CART

A companion to Mogogo's full product range or a standalone cart for table side service, room service, display, or any other occasion.



(shown with optional Golden-Brown quick covers)

The three level service cart is equipped with panel bumpers to avoid unwanted wear and tear to the cart tops. Heavy-duty casters and a comfortable handle will allow easy navigation of the Roll'n Cart around any tricky event.

MG CRNX01 BSXX



MG CRNX01 WBXX
(shown with optional Golden-Brown quick cover)

High-Density Bamboo finish only available in North America

MATERIAL GUIDE

Customize your Roll'n Service Carts by choosing from the different colors and finishes available. Simply choose your preferred design combination by inserting the corresponding letter to its designated space as demonstrated below.

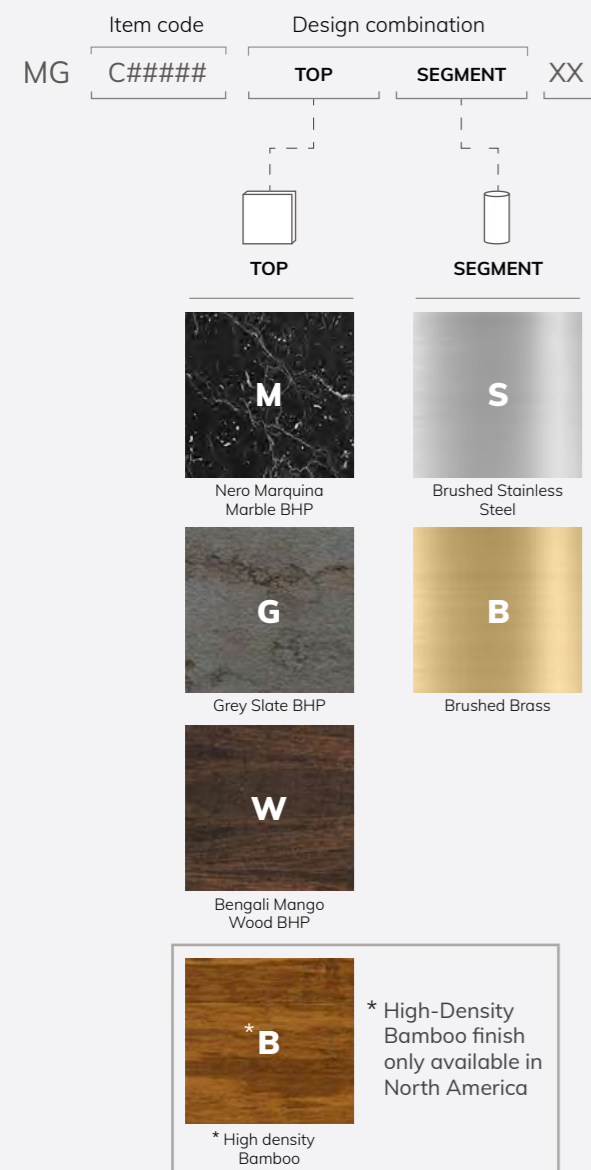

EXAMPLE:
MG CRNX01 MSXX =



TOP BORDER CART

Get that extra stability with a top border cart. Beautiful and chic while being extremely practical and useful for "on the move" service.



MG CRNX02 MSXX
(shown with optional Charcoal-Black quick cover)



(shown with optional Jungle-Green quick covers)

The original Roll'n Service Cart customized with a border on the top level.

MG CRNX02 WBXX

High-Density Bamboo finish only available in North America

MATERIAL GUIDE

Customize your Roll'n Service Carts by choosing from the different colors and finishes available. Simply choose your preferred design combination by inserting the corresponding letter to its designated space as demonstrated below.

Item code: MG C#####

Design combination: TOP SEGMENT XX

TOP	SEGMENT
M Nero Marquina Marble BHP	S Brushed Stainless Steel
G Grey Slate BHP	B Brushed Brass
W Bengali Mango Wood BHP	
*B * High density Bamboo	* High-Density Bamboo finish only available in North America

EXAMPLE:
MG CRNX01 MSXX =



CHEESE PLATE AND WINE CART

Bring your guests an authentic French Aperitif experience with our versatile Cheese and Wine Cart.



MG CRNX04 MSXX



(shown with optional Silver-Grey quick covers)

The original Roll'n Service Cart customized with a border, a cheese tray, a leather towel hanger, and a champagne bucket.

MG CRNX04 G\$XX

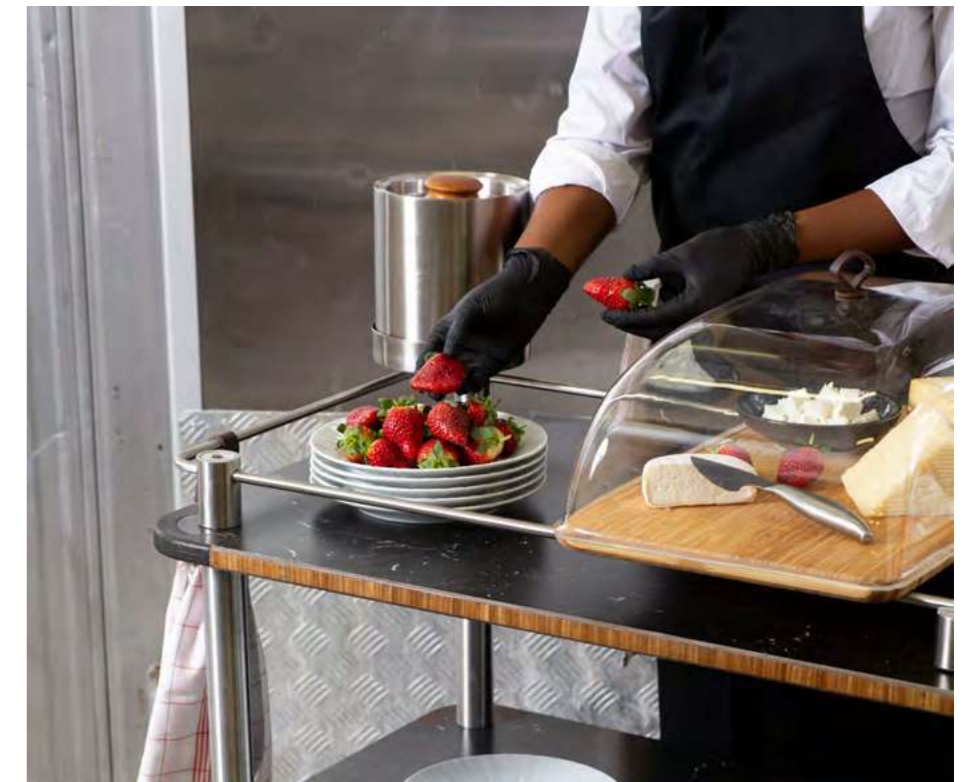

MATERIAL GUIDE

Customize your Roll'n Service Carts by choosing from the different colors and finishes available. Simply choose your preferred design combination by inserting the corresponding letter to its designated space as demonstrated below.

Item code: MG C#####
 Design combination: TOP SEGMENT XX

TOP	SEGMENT
M Nero Marquina Marble BHP	S Brushed Stainless Steel
G Grey Slate BHP	B Brushed Brass
W Bengali Mango Wood BHP	
*B * High density Bamboo	* High-Density Bamboo finish only available in North America

EXAMPLE:
 MG CRNX01 MSXX =



MIXOLOGY CART

Get a step ahead of the Mixology trend by giving your experienced bartenders the perfect mixing companion.



MG CRNX03 MSXX
 (shown with optional Charcoal-Black quick cover)



(shown with optional Charcoal-Black quick covers)

The original Roll'n Service Cart customized with a border, leather towel hanger, wood cutting board, wine glass holders, and an ice bucket.

MG CRNX03 MSXX

High-Density Bamboo finish only available in North America

DAY & NIGHT

Roll'n Service Carts can serve guests tea at breakfast, or entertain with a wine cart at an evening event.



TOP BORDER CART MG CRNX02 WBXX
(shown with optional Golden-Brown quick covers)

MIXOLOGY CART MG CRNX03 MSXX
(shown with optional Jungle-Green quick covers)



TOP BORDER CART MG CRNX02 MSXX
(shown with optional Charcoal-Black quick covers and ice/champagne bucket)













SYSTEM BREAKDOWN

Roll'n System Breakdown consists of BHP panels in three different finishes or high-density bamboo panels, leg segments available in two finishes, as well as an ever-expanding collection of functional accessories.

This wide selection gives you the freedom to design your own cart depending on your specific needs or transform your existing basic cart into a Cheese and Wine Cart or a Mixology Cart.

MOGOGO TOOLS

	1 piece	ALLEN KEY FOR M16	MG SAUXSS 0101
	1 piece	M16 SCREWS	MG SSCWMT 0101
 	1 piece	BLACK SCREW CAP	MG SSACPL 0601
 	1 piece	GREY SCREW CAP	MG SSACPL 0501
 	1 piece	BROWN SCREW CAP	MG SSACPI 0201
 X1  X2  X12		UTILITY KIT: ALLEN KEY FOR M16 2 M16 SCREWS 12 SCREW CAPS (4 Screw caps X 3 colors)	MG SSACSM 0102

MATERIAL GUIDE

Customize your Roll'n Service Carts by choosing from the different colors and finishes available. Simply choose your preferred design combination by inserting the corresponding letter to its designated space as demonstrated below.

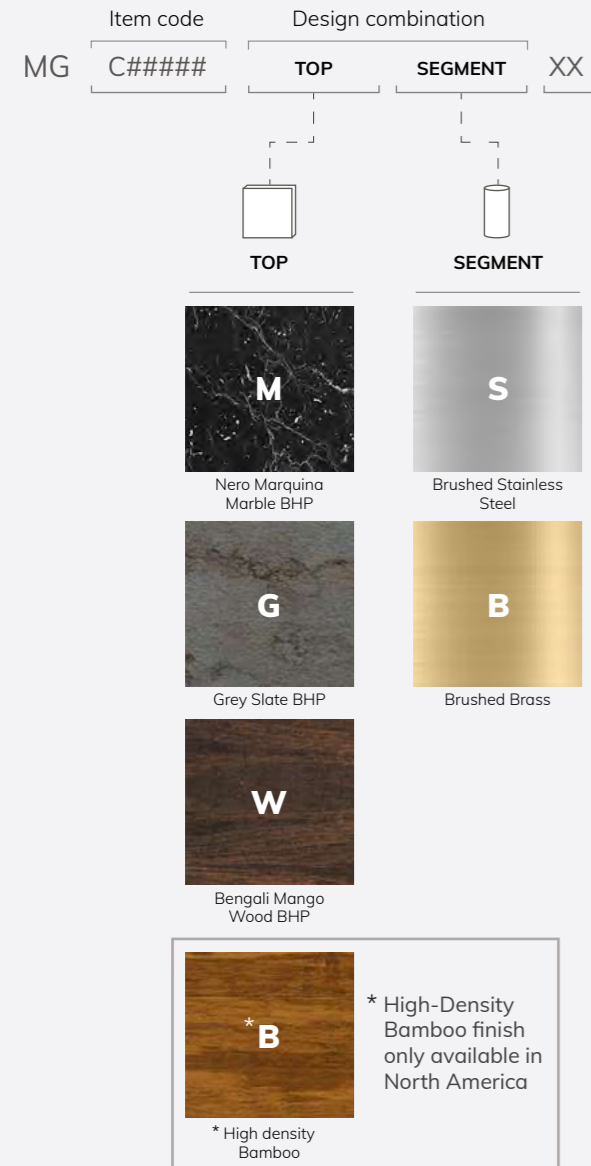

EXAMPLE:
MG CRNX01 MSXX =



SERVICE CART



SERVICE CART
L41.5" W21" H36"
L105cm W53cm H91cm

MG CRNX01 __ XX

QUICK COVERS

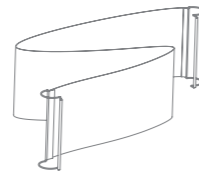

SERVICE CART QUICK COVERS
2 per box

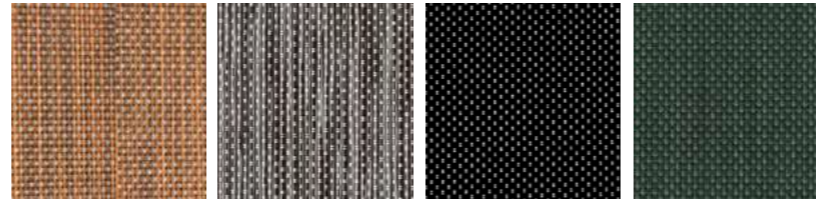

Golden-Brown Silver-Grey Charcoal-Black Jungle-Green

MG SQCOV 1301 MG SQCOV 1401 MG SQCOV 2101 MG SQCOG 0701



SERVICE CART STORAGE COVERS
2 per box

MG SQCOV 2902 MG SQCOV 3602 MG SQCOV 3702 MG SQCOG 1202

ADD-ONS

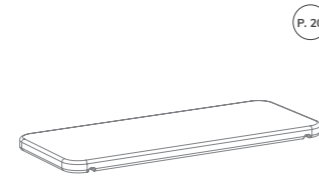

CUTTING BOARD
L19" W8" H0.7"
L49cm W20cm H2cm
fits Border

MG SSCMBM 0201

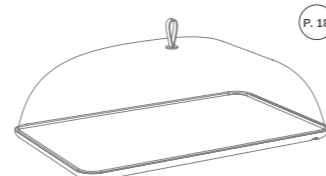

CHEESE TRAY
L19" W12" H7"
L49cm W30cm H17cm
fits Border

MG SSCMBM 0501

ADD-ONS

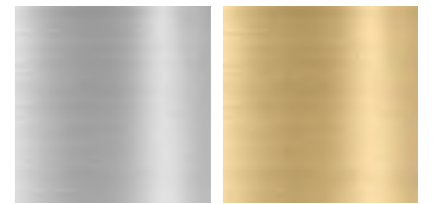

Brushed Stainless Steel Brushed Brass

MG SSCMSS 0401 MG SSCMBR 0101

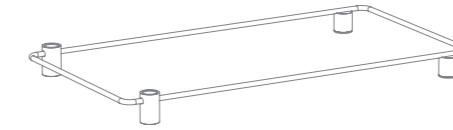

BORDER
L31.5" W17" H2"
L80cm W44cm H5cm
fits service cart



LEATHER TOWEL HANGER
fits Border

MG SSCMSL 0101 MG SSCMSL 0201



WINE GLASS HOLDER
L21" W4" H2"
L53cm W11cm H5.5cm
Holds up to 6 wine glasses

MG SSCMSS 0501 -/-



ICE / CHAMPAGNE BUCKET
Ø6" H6"
Ø15.5cm H15.5cm
fits Border

MG SSCMSS 0601 -/-

mogogo
BUFFET SOLUTIONS



POLO
TABLES

2022/2023

DISTRIBUTED BY:  **steelite**
INTERNATIONAL



SQUARE BISTRO TABLE MG CPRS01 WSXX \ \ **ROUND BISTRO TABLE** MG CPRR01 MSXX

INDEX



A PROFESSIONAL
FOOD & BEVERAGE
FURNITURE COMPANY

BORN FROM AN INTERDISCIPLINARY
PASSION FOR **Design x Food**



Mogogo is led by designers and chefs that are driven by the desire to introduce new, beautiful, and functional products to the market, with an environmentally friendly philosophy in mind.

WE PUSH
THE CREATIVE ENVELOPE
OF FUNCTION AND INNOVATION.



LINENLESS



MODULAR



MOBILE



SUSTAINABLE



ADD ONS



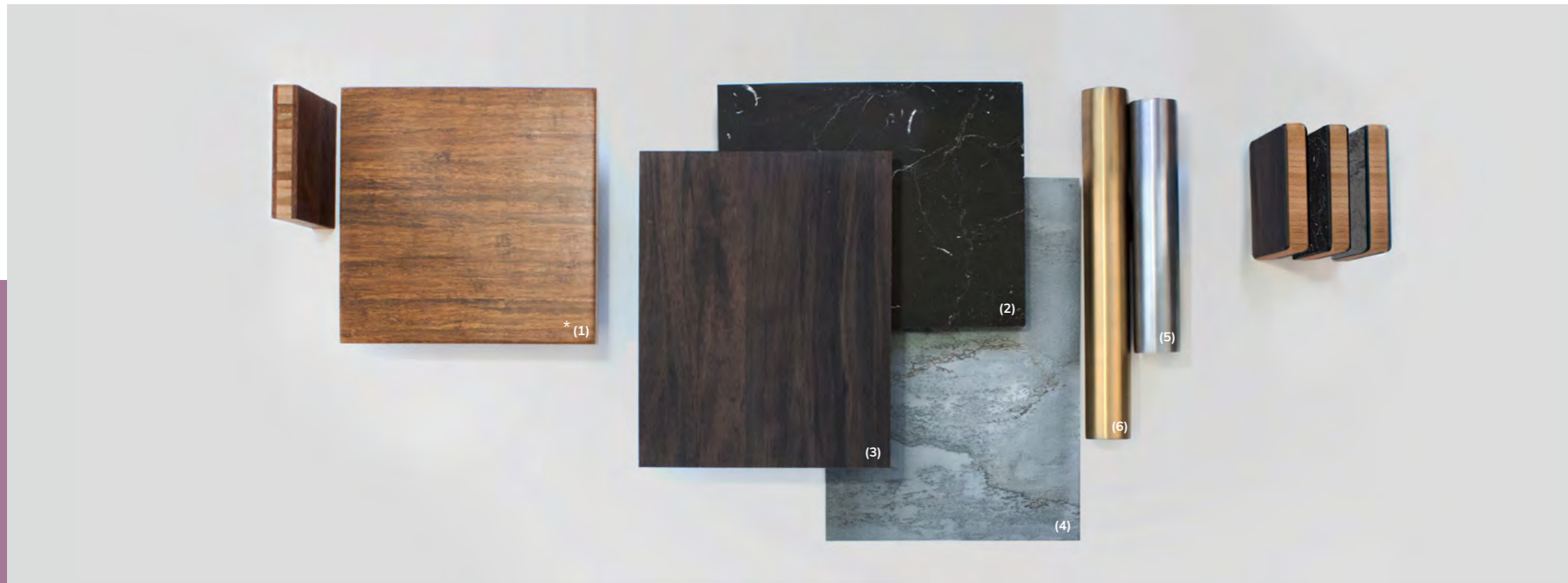

ABOUT POLO COLLECTION

Mogogo's PoLo Tables are lightweight and extremely versatile, designed using our unique Modular System.

Available in Round, Square, or Oval Tabletop shapes, they offer a wide variety of combinations.

This approach allows for the same coffee table to be effortlessly transformed into a bistro or bar table and then into a champagne or dessert station in no time. It provides you with flexibility while also retaining simplicity and style.

MATERIALS

Joining our Bamboo **(1)*** collection is our new innovative BHP material. BHP is a newly composed material that arrived after two years of intense R&D. It merges layers of High-Pressure Laminate with a Vertical Bamboo core (Mogogo's expertise) creating a lighter yet durable panel that offers new textures and colors. This new material combines the advantages of both bamboo and HPL, perfect for the ever-changing needs of the hospitality industry. Available in a variety of finishes that resemble natural materials such as Nero Marquina Marble, Bengali Mango Wood, and Grey Slate, **(2-4)**, making it easy to match with any event and decor.

The innovative bamboo core of the BHP goes in line with Mogogo's sustainability motto while the HPL's outer coating is durable for different environments, hygienic, and easy to clean.

PoLo segments come in 2 finishes: brushed stainless steel **(5)** and brushed brass **(6)**.

* High-Density Bamboo finish only available in North America

HOW IT WORKS

Mogogo's PoLo Tables' industrial design is based on the Modular System. Delivered to you in flat packaging, it is easy and fast to assemble and disassemble. Composed of the same individual components (tabletops, leg segments, and mid-part segments) it gives you the flexibility to transform the same coffee table into a bistro table, a bar table, or a display table.

PoLo's cross base and adjustable legs give it stability and the flexibility to adapt your table to any terrain. The clean one pole design makes this table blend easily into any design scheme and event space.

Highly versatile while offering durability and functionality, PoLo Tables enable you to use your creativity. Play with heights, tabletop shapes (round, square, or oval), different finishes, and add shelving layers as needed for additional display.

FLAT PACK PACKAGING

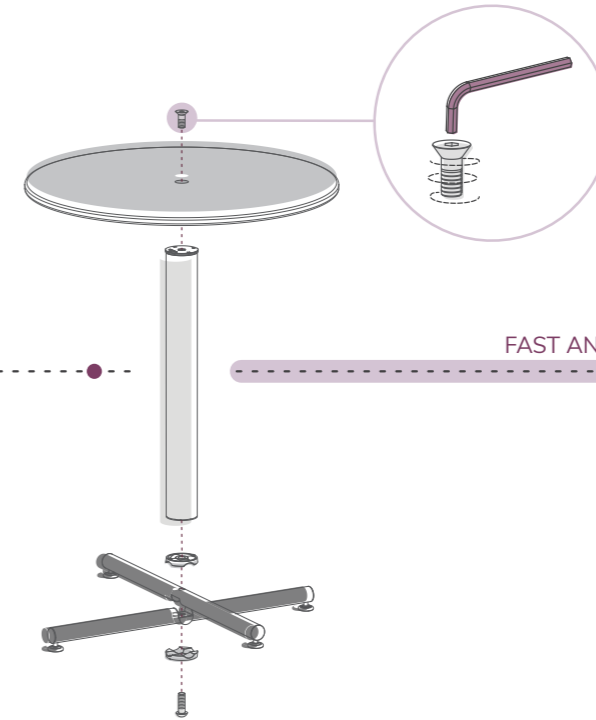
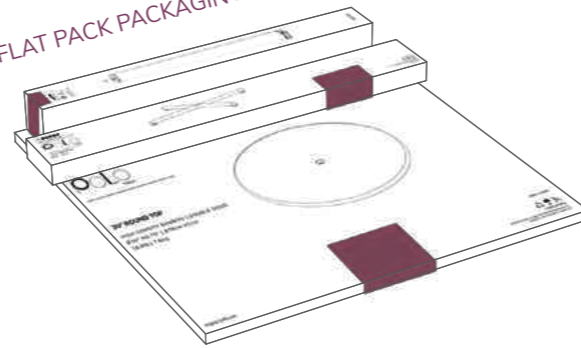

FAST AND EASY ASSEMBLY

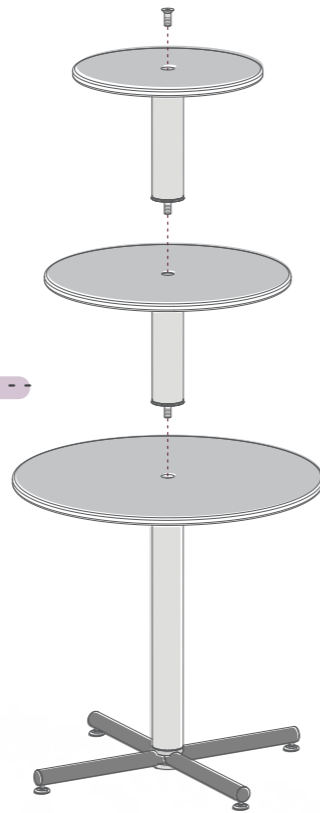

ROUND DISPLAY TABLE

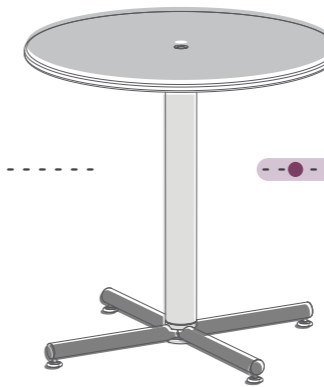

ROUND BISTRO TABLE

POLO TABLES
COFFEE / DISPLAY / BISTRO

MIX AND MATCH



ADAPTS TO ANY OCCASION.



MG CPPS01 WBXX



MG CPRR01 MBXX



COLOR COMBINATIONS



MG CPBR01GBXX

Different colors, shapes, and heights make the PoLo table perfect for multiple combinations and styles. Completely transform the atmosphere of your event by changing the tables' heights. From bar to bistro to coffee tables, try a combination to maximize space.



MG CPFV01 MSXX



*
Mix Nero Marquina Marble finish with brass for an elegant, classy look, while Grey Slate with stainless gives it an urban and outdoor feel.



MG CPBS02 WSXX





OVAL COFFEE TABLE MG CPFV01 WSXX



COFFEE TABLES

In addition to being lightweight, quickly assembled, and versatile while offering durability, Mogogo Coffee Tables can be placed anywhere in the room, for both decorative and service purposes.

Combined with other available heights and tabletop shape options, you can create interesting visual variations in elevations to further add to your stylish display.

MATERIAL GUIDE

Customize your PoLo Tables by choosing from the different colors and finishes available. Simply choose your preferred design combination by inserting the corresponding letter to its designated space as demonstrated below.

Item code: MG C#####

Design combination: TOP SEGMENT XX

TOP:  TOP

SEGMENT:  SEGMENT

M
Nero Marquina Marble BHP

S
Brushed Stainless Steel

G
Grey Slate BHP

B
Brushed Brass

W
Bengali Mango Wood BHP

***B**
* High-Density Bamboo finish only available in North America
* High density Bamboo

EXAMPLE:

MG CPBR01 MSXX =



ROUND COFFEE TABLE

Beautiful round coffee table for any small and intimate setup.

MG CPFR01 BSXX



SQUARE COFFEE TABLE

An elegant and stylish squared coffee table that will fit perfectly in any setup.

MG CPFS01 MBXX



OVAL COFFEE TABLE

Ideal oval shaped top that is bigger in size, making it perfect for a lounge or food display.

MG CPFV01 GSXX



SQUARE BISTRO TABLE MG CPRS01 WBXX







BISTRO TABLES

The 30" (76 cm) table is the most common height and diameter utilized for dining tables in the hospitality industry. Available in both round and square tabletop shapes, the Mogogo PoLo Tables unique modular system allows to be transformed into a highboy or three-tier dessert station in just a few steps.

Mogogo Bistro Tables are designed for a lightweight, stylish, and clean look, in addition to their flexible and functional properties.

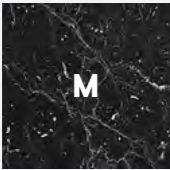
MATERIAL GUIDE

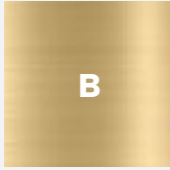
Customize your PoLo Tables by choosing from the different colors and finishes available. Simply choose your preferred design combination by inserting the corresponding letter to its designated space as demonstrated below.

Item code	Design combination	
MG C#####	TOP	SEGMENT XX
		
	TOP	SEGMENT
		
	M	S
	Nero Marquina Marble BHP	Brushed Stainless Steel
		
	G	B
	Grey Slate BHP	Brushed Brass
		
	W	
	Bengali Mango Wood BHP	
		
	*B	
	* High density Bamboo	
	* High-Density Bamboo finish only available in North America	

EXAMPLE:

MG CPBR01 MSXX =



ROUND BISTRO TABLE

Ultimate round top dining table for any hospitality setting, with perfect height making it accessible.

MG CPRR01 GSXX



SQUARE BISTRO TABLE

Square dining table, the perfect size that fits any venue or display.

MG CPRS01 WBXX

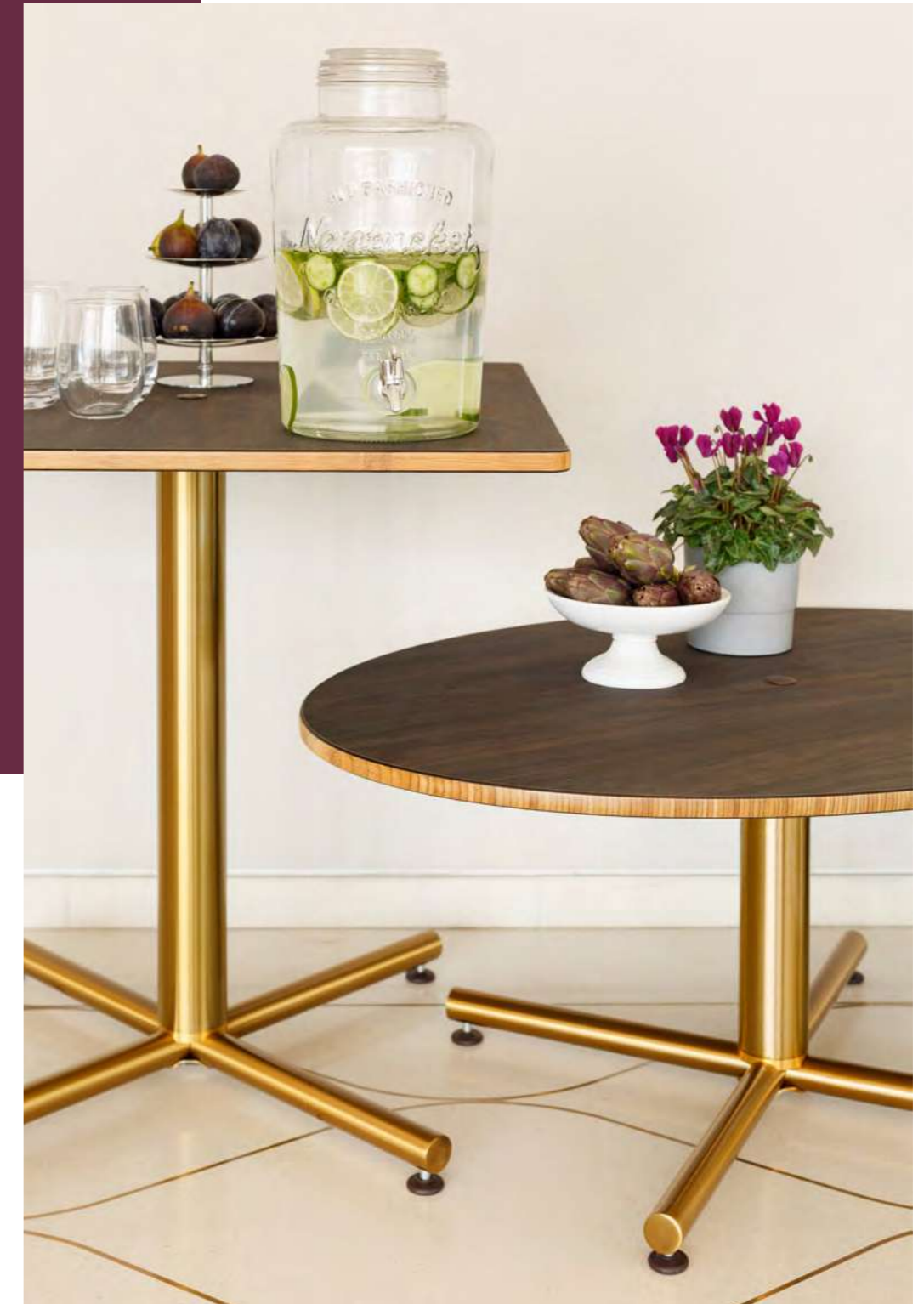

SQUARE BISTRO TABLE MG CPRS01 WBXX || **OVAL COFFEE TABLE** MG CPFV01 WBXX

High-Density Bamboo finish only available in North America

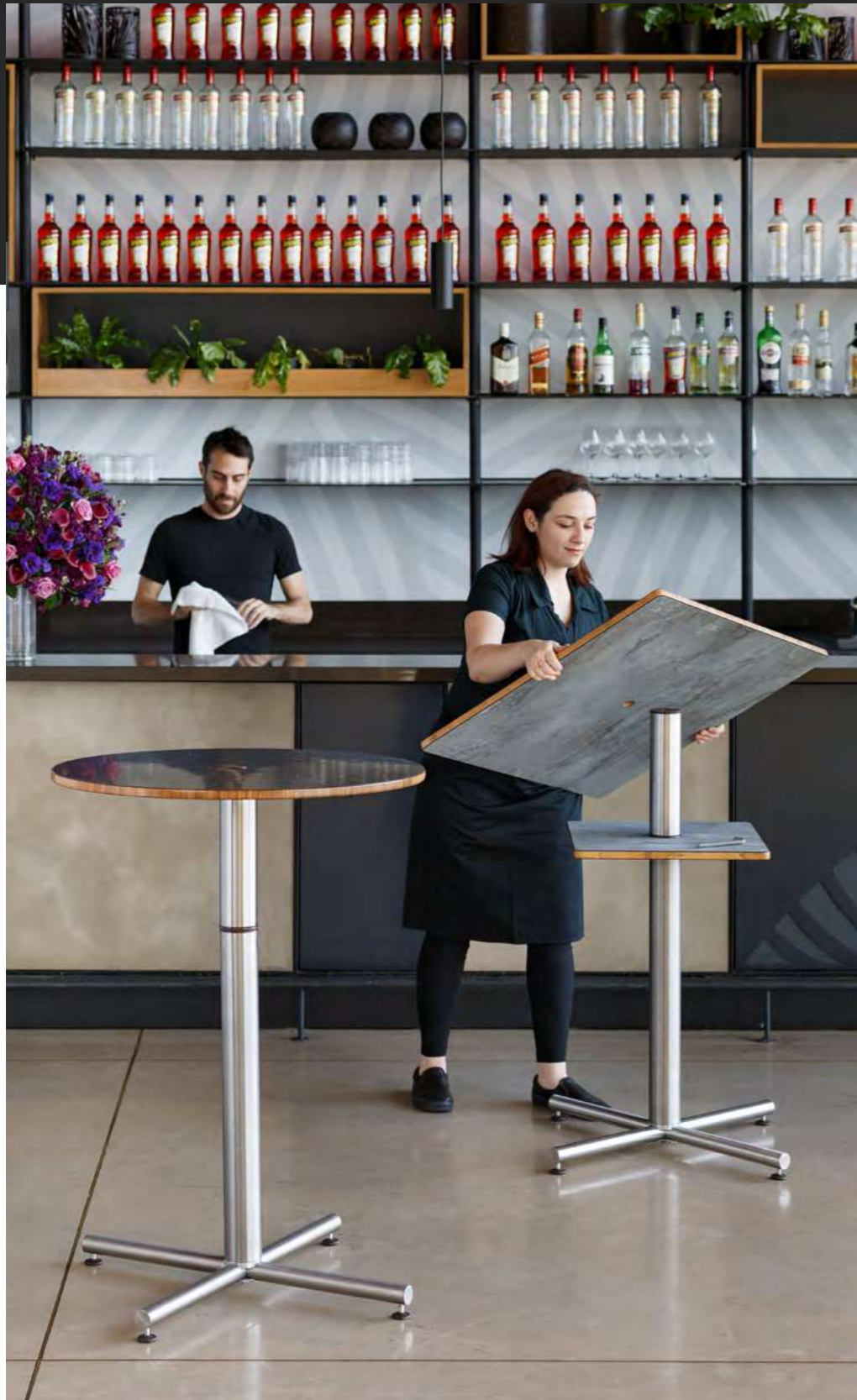

ROUND BAR TABLE MG CPBR01 MSXX \ \ **SQUARE BAR TABLE + SHELF** MG CPBS02 GSXX

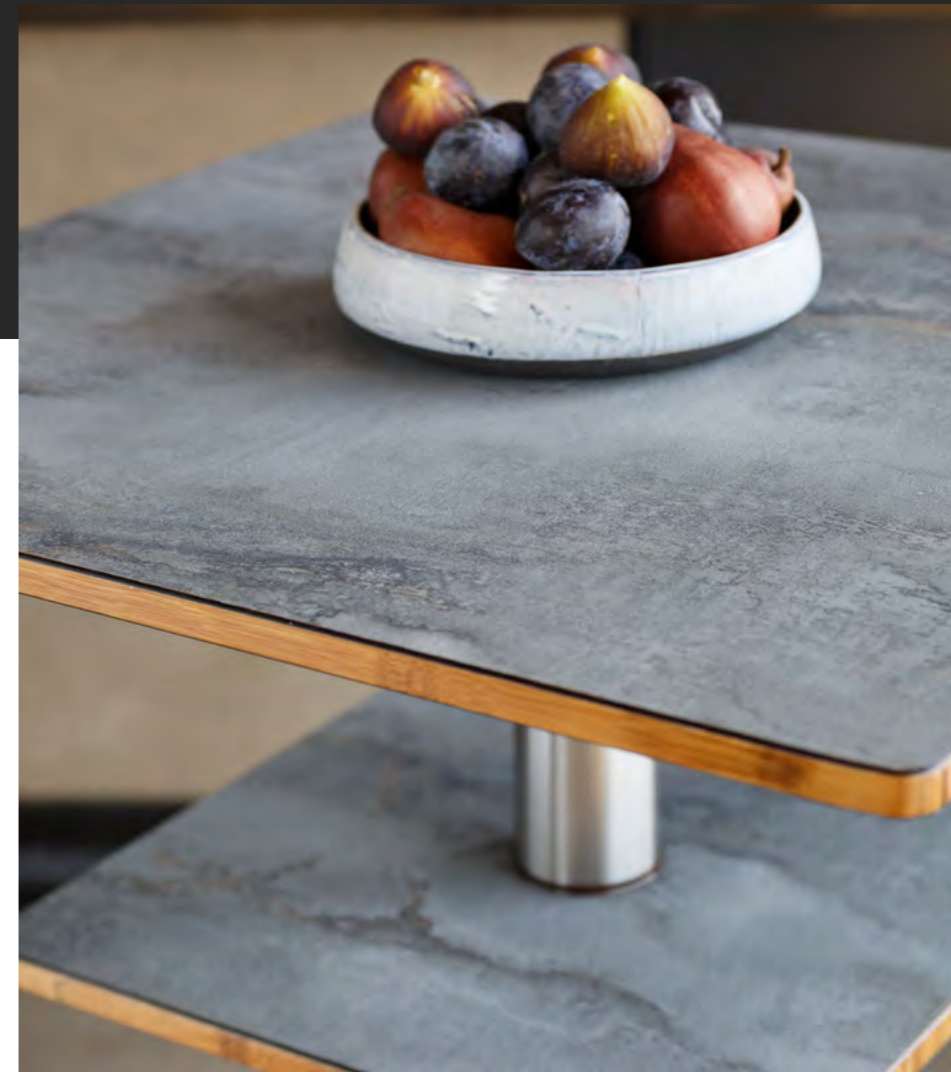

BAR TABLES

Mogogo Bar Tables consist of Round or Square Tabletops and elongated bases made of brushed stainless steel or brushed brass finish.

In addition to being sleek and eye-catching from anywhere in the room, these tables are highly sturdy and can be used in a number of ways. Additionally, can be placed near different height round or square tables for a unique take on serving drinks or delicacies.

MATERIAL GUIDE

Customize your PoLo Tables by choosing from the different colors and finishes available. Simply choose your preferred design combination by inserting the corresponding letter to its designated space as demonstrated below.

Item code: MG C#####
 Design combination: TOP SEGMENT XX



TOP



SEGMENT



M
Nero Marquina
Marble BHP

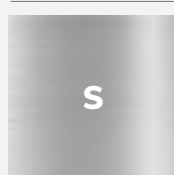

S
Brushed Stainless
Steel



G
Grey Slate BHP

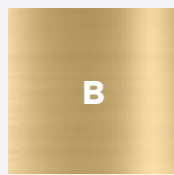

B
Brushed Brass



W
Bengali Mango
Wood BHP

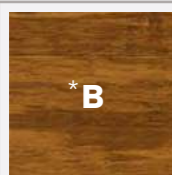

* B
* High density
Bamboo

* High-Density
Bamboo finish
only available in
North America

EXAMPLE:

MG CPBR01 MSXX =



Ø30" H42"
Ø76cm H106cm

ROUND BAR TABLE

Easily portable round top that completes any fancy cocktail party.

MG CPBR01 WSXX



L30" W30" H42"
L76cm W76cm H106cm

SQUARE BAR TABLE

Square bar table that looks fantastic in every social gathering.

MG CPBS01 GSXX



Ø30" H42.5"
Ø76cm H108cm

ROUND BAR TABLE + SHELF

Perfect round bar table with added lower shelf for modularity and style.

MG CPBR02 MBXX



L30" W30" H42.5"
L76cm W76cm H108cm

SQUARE BAR TABLE + SHELF

Refined Square bar table with a shelf that is great to expose food or beverage in a unique way.

MG CPBS02 BBXX

DAY & NIGHT

PoLo Tables fit in your morning coffee lounge just as well as they do in elegant evening events.



ROUND COFFEE TABLE MG CPFR01 GSXX



ROUND DISPLAY TABLE MG CPPR01 WBXX



ROUND DISPLAY TABLE MG CPPR01 MBXX



DISPLAY TABLES

Celebrate in style with these elegant Round or Square Top Display Tables.

Create an artistic design to help enrich and elevate the way you serve. Choose this table in order to show off a divine selection of hors-d'oeuvres, wine, mixed drinks, or any type of finger food.





With an elevated base and impressive decoration, Mogogo Display Tables are visible from anywhere in the room and can serve desserts, champagne, or anything else you would like to bring to the attention of your guests.

MATERIAL GUIDE

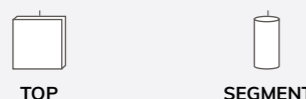
Customize your PoLo Tables by choosing from the different colors and finishes available. Simply choose your preferred design combination by inserting the corresponding letter to its designated space as demonstrated below.

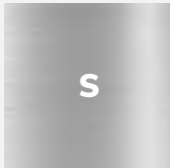
Item code: MG C#####
 Design combination: TOP SEGMENT XX

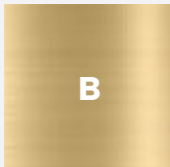
 TOP SEGMENT

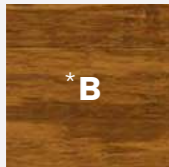
 M Nero Marquina Marble BHP	 S Brushed Stainless Steel
 G Grey Slate BHP	 B Brushed Brass
 W Bengali Mango Wood BHP	
 *B * High density Bamboo	* High-Density Bamboo finish only available in North America

EXAMPLE:
 MG CPBR01 MSXX =



ROUND DISPLAY TABLE

Graceful round display table with two shelves that adds a special touch to all your food and beverages.

MG CPPR01 MBXX



SQUARE DISPLAY TABLE

Classic yet fashionable square display table with two shelves that complete any display beautifully.

MG CPPS01 GSXX



SQUARE DISPLAY TABLE MG CPPS01 GSXX

TRANSFER & STORAGE CARTS

Mogogo's utility carts are designed for your convenience and mobility and are an integral part of the PoLo system as they make storing and assembling the tables easy. Whether it is to pull out the tabletops, to push them through the halls, or get in and out of elevators; they make the behind the scenes of your time-sensitive events easier and give you an extra push on productivity.



**SEGMENTS AND ADD-ONS
TRANSFER AND STORAGE CART**
L55.5" W31" H50"
L141cm W79cm H127.5cm
holds segments and cross bases for 15 PoLo tables

MG CUUX01 XXXX

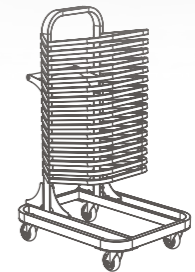

**ROUND / SQUARE TOP
TRANSFER AND STORAGE CART**
L40" W31" H61"
L101cm W79cm H155cm
holds up to 16 PoLo round/square tops

MG CUUX04 XXXX

UTILITY CART ADD-ON



**ROUND / SQUARE TOP CART ADD-ON
SMALL SHELF STORAGE**
L37" W17.5" H3"
L94cm W44cm H7.5cm
Holds a minimum of 16 PoLo round/square shelves
MG SADDPS 0201













SYSTEM BREAKDOWN

Mogogo's PoLo Table Collection is composed of three different shapes of tabletops: round, square and oval. Different sizes of leg segments are available in two finishes and optional smaller shelves in corresponding shapes.

Three types of parts; endless possibilities and table functions.

MOGOGO TOOLS

	1 piece	ALLEN KEY FOR M16	MG SAUXSS 0101
	1 piece	M16 SCREWS	MG SSCWMT 0101
 	1 piece	BLACK SCREW CAP	MG SSACPL 0601
 	1 piece	GREY SCREW CAP	MG SSACPL 0501
 	1 piece	BROWN SCREW CAP	MG SSACPI 0201
 X1  X2  X12		UTILITY KIT: ALLEN KEY FOR M16 2 M16 SCREWS 12 SCREW CAPS (4 Screw caps X 3 colors)	MG SSACSM 0102

LEGS



Brushed Stainless Steel Brushed Brass

MG SPOLSS 0301 MG SPOLBR 0301

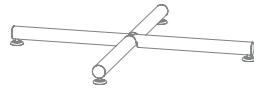

CROSS BASE
30" | 76cm



12" SEGMENT
H12" | H30cm

MG SLEGSS 0101 MG SLEGBR 0301



15" SEGMENT
H15" | H38cm

MG SPOLSS 0101 MG SPOLBR 0101



26" SEGMENT
H26" | H67cm

MG SPOLSS 0201 MG SPOLBR 0201

TOPS



* High density Bamboo Bengali Mango Wood BHP Grey Slate BHP Nero Marquina Marble BHP

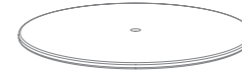

30" ROUND TOP
Ø30" | Ø76cm

MG SCRTBM 0102 MG SCRTHW 0101 MG SCRTHG 0101 MG SCRTHB 0101



24" ROUND TOP
Ø24" | Ø60cm

MG SCRTBM 0202 MG SCRTHW 0201 MG SCRTHG 0201 MG SCRTHB 0201



18" ROUND TOP
Ø18" | Ø46cm

MG SCRTBM 0302 MG SCRTHW 0301 MG SCRTHG 0301 MG SCRTHB 0301

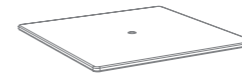

30" SQUARE TOP
30" | 76cm

MG SPOLBM 0401 MG SPOLHW 0401 MG SPOLHG 0401 MG SPOLHB 0401

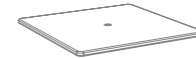

24" SQUARE TOP
24" | 60cm

MG SPOLBM 0301 MG SPOLHW 0301 MG SPOLHG 0301 MG SPOLHB 0301

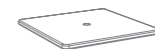

18" SQUARE TOP
18" | 46cm

MG SPOLBM 0201 MG SPOLHW 0201 MG SPOLHG 0201 MG SPOLHB 0201



42.5" OVAL TOP
L42.5" W30" | L108cm W76cm

MG SPOLBM 0101 MG SPOLHW 0101 MG SPOLHG 0101 MG SPOLHB 0101

mogogo
BUFFET SOLUTIONS



DiX
TABLES

2022/2023

DISTRIBUTED BY:  **steelite**
INTERNATIONAL



H30" ROUND TABLE MG CCVR01 WBXX \ \ MG CCVR01 GBXX

INDEX



A PROFESSIONAL
FOOD & BEVERAGE
FURNITURE COMPANY

BORN FROM AN INTERDISCIPLINARY PASSION FOR **Design x Food**



Mogogo is led by designers and chefs that are driven by the desire to introduce new, beautiful, and functional products to the market, with an environmentally friendly philosophy in mind.

WE PUSH
THE CREATIVE ENVELOPE
OF FUNCTION AND INNOVATION.



LINENLESS



MODULAR



MOBILE



SUSTAINABLE



ADD ONS



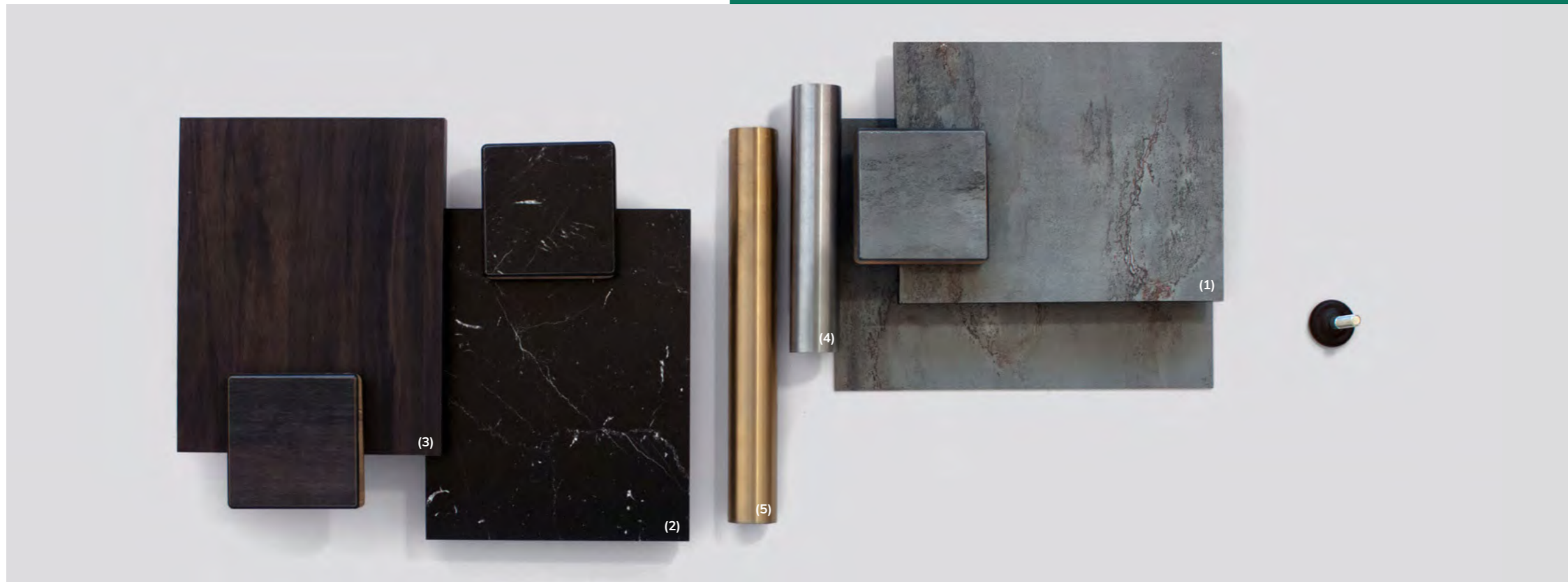

ABOUT CLIX COLLECTION

Like everything designed by Mogogo, CliX is both functional and beautiful, all while making the lives of our customers a little bit easier. CliX is inspired by the existing strengths of Mogogo's modular buffet furniture while further exploring versatility and adaptability. From these two function-defining parameters came our patent-pending quick-lock mechanism. One click to attach and one twist to detach, CliX delivers a product that is easy to assemble and store.

Available in three different heights as well as three tabletop shapes each with three different finishes, CliX is another part of our quest to produce tools for professionals that combine maximum functionality with a refined design aesthetic.

CliX Tables redefine aesthetic and functional standards in the realm of F&B catering.

MATERIALS

CliX tops are made of our innovative BHP material. BHP is a newly composed material that arrived after two years of intense R&D. It merges layers of High-Pressure Laminate with a Vertical Bamboo core (Mogogo's expertise) creating a lighter yet durable panel that offers new textures and colors. This new material combines the advantages of both bamboo and HPL, perfect for the ever-changing needs of the hospitality industry. Available in a variety of finishes that resemble natural materials such as Grey Slate, Nero Marquina Marble, and Bengali Mango Wood **(1-3)**, CliX makes it easy to match with any event and decor.

The innovative bamboo core of the BHP goes in line with Mogogo's sustainability motto while the HPL's outer coating is durable for different environments, hygienic, and easy to clean.

CliX bases come in 2 modern chic finishes- brushed stainless steel **(4)** and brushed brass **(5)**.

HOW IT WORKS

Our unique patent-pending quick-lock mechanism and universal base, for the CliX Tables collection, makes it easy to store, assemble, and disassemble: one click to attach and one twist to detach. With a multiplicity of tabletop/base combinations to choose from, CliX Tables provide you with an unprecedented array of display options. CliX Collection offers a variability of tabletop shapes and materials, as well as different base heights and finishes giving you the freedom to create an interesting visual landscape.

CliX Tables are an elegant design solution for any F&B operation. When you combine form and function, it just CliX.

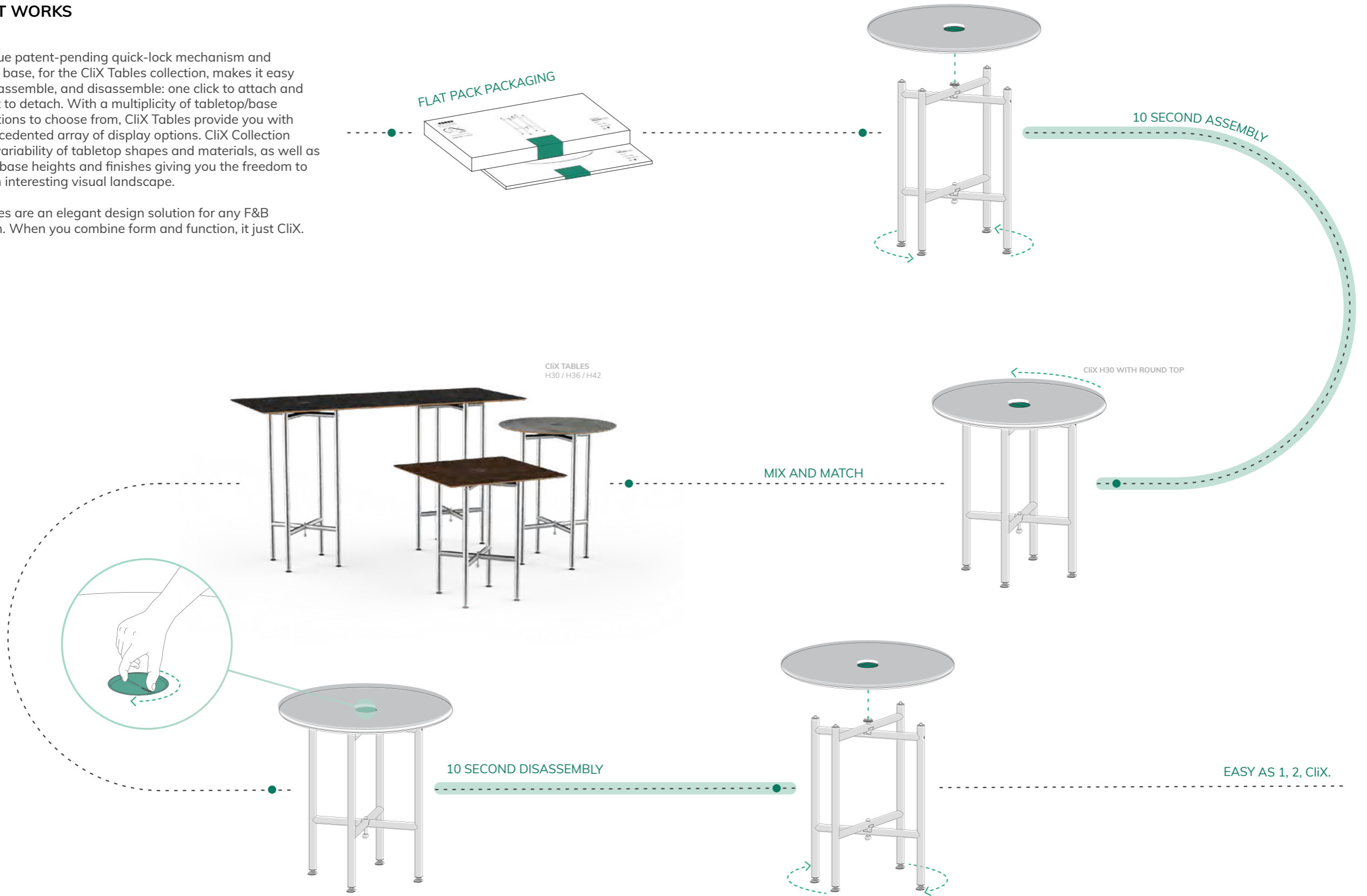



MG CCVS01 MSXX (shown with optional bottom shelf)



MG CCYG01 GSXX



COLOR COMBINATIONS

CliX's versatility allows for multiple color combinations, perfect for creating different vibes that are easily adaptable in multiple environments.



MG CCZG01 MBXX (shown with optional bottom shelves)

*
Mix Nero Marquina Marble finish with brass for an elegant, classy look, while Grey Slate with stainless gives it a more modern and sleek feel.



MG CCVR01 GBXX (shown with optional bottom shelf)



MG CCVG01 WBXX (shown with optional bottom shelves)

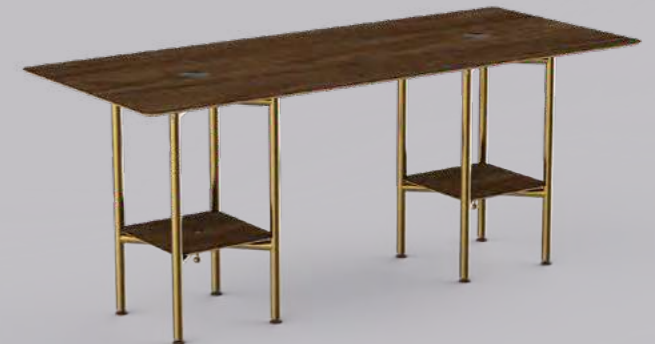



H30" RECTANGLE TABLE MG CCVG01 WBXX \ \ **H42" SQUARE TABLE** MG CCZS01 WBXX
 (shown with optional Square BHP bottom shelves in a Bengali Mango Wood finish)



H30" SQUARE TABLE MG CCVS01 MSXX

H30" TABLES

CliX H30 embodies the most popular height for Catering Tables.

Standard in height, but not in design: CLiX H30 instantly elevates the event atmosphere to something quite sophisticated and chic.

Available in round, square, and rectangle tabletops, CliX H30 is an essential piece for any high end or laid back catering events; adding the perfect twist that clicks.

MATERIAL GUIDE

Customize your CliX Tables by choosing from the different colors and finishes available.

Simply choose your preferred design combination by inserting the corresponding letter to its designated space as demonstrated below.

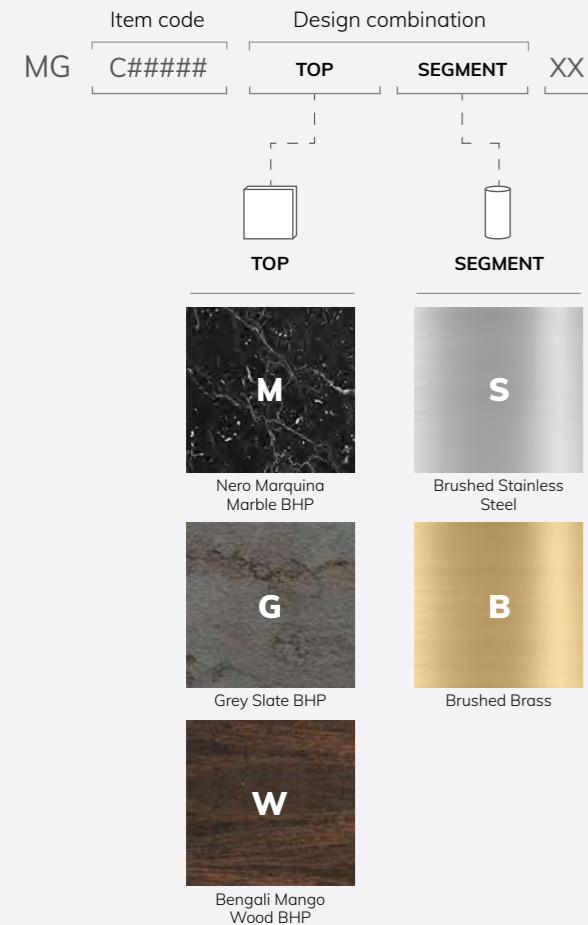

EXAMPLE:

MG CCVR01 WBXX =



H30" ROUND TABLE

CliX H30" | 76cm Base with a Round BHP top.
Food displays will be at a whole other level with the CliX catering tables.

MG CCVR01 GBXX



H30" SQUARE TABLE

CliX H30" | 76cm Base with a Square BHP top.
With these CliX tables, put together an events' buffet in just seconds.

MG CCVS01 MSXX



H30" RECTANGLE TABLE

CliX H30" | 76cm Base with a Rectangle BHP top.
Showcase delicious food on a larger and elegant CliX Table.

MG CCVG01 WSXX



H36" SQUARE TABLE MG CCYS01 MSXX

(shown with optional Square BHP bottom shelf in a Nero Marquina Marble finish)

H30" ROUND TABLE MG CCVR01 GSXX

(shown with optional Round BHP bottom shelf in a Grey Slate finish)



H36" RECTANGLE TABLE MG CCYG01 WBXX

H36" TABLES

CliX H36 serves as the perfect intermediate between a Bar and Dining Table height.

Created to add further vertical diversity, it is a great addition to its other catering companions.

Available in round, square, and rectangle tabletops, CliX H36 completes the vision of a diverse and surprising visual landscape for any event.

MATERIAL GUIDE

Customize your CliX Tables by choosing from the different colors and finishes available.

Simply choose your preferred design combination by inserting the corresponding letter to its designated space as demonstrated below.

Item code: MG C#####
 Design combination: TOP SEGMENT XX



TOP



SEGMENT



Nero Marquina
Marble BHP

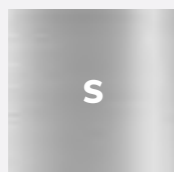

Brushed Stainless
Steel



Grey Slate BHP

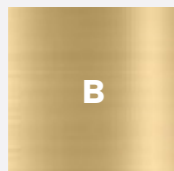

Brushed Brass



Bengali Mango
Wood BHP

EXAMPLE:

MG CCVR01 WBXX =



Ø30" H36"
 Ø76cm H91cm

H36" ROUND TABLE

CliX H36" | 91cm Base with a Round BHP top.
 Smoothly gather guests around CliX tables at any event.

MG CCYR01 MSXX



L30" W30" H36"
 L76cm W76cm H91cm

H36" SQUARE TABLE

CliX H36" | 91cm Base with a Square BHP top.
 Easily mobile and light, the CliX are perfect for ever-changing events.

MG CCY01 WBXX



L72" W30" H36"
 L182cm W76cm H91cm

H36" RECTANGLE TABLE

CliX H36" | 91cm Base with a Rectangle BHP top.
 This CliX rectangular shape allows for multiple food displays and options.

MG CCYG01 GSXX



H42" SQUARE TABLE MG CCZS01 WBXX
 (shown with optional Square BHP bottom shelf in a Bengali Mango Wood finish)



H42" RECTANGLE TABLE MG CCZG01 GSXX \\ **H36" ROUND TABLE** MG CCYR01 GSXX
 (shown with optional Round BHP bottom shelf in a Grey Slate finish)

H42" TABLES

CliX H42 is a high and lightweight catering table, perfect as a High-Boy Bar Table or simply used as a Display table.

Ten seconds to assemble, ten seconds to disassemble, discover a new dimension of functionality with our patent pending mechanism.

Available in round, square, and rectangle tabletops, CliX H42 will upgrade any catering space into a high-end-design social environment.

MATERIAL GUIDE

Customize your CliX Tables by choosing from the different colors and finishes available.

Simply choose your preferred design combination by inserting the corresponding letter to its designated space as demonstrated below.

Item code: MG C#####
 Design combination: TOP SEGMENT XX



TOP



SEGMENT



M
Nero Marquina
Marble BHP

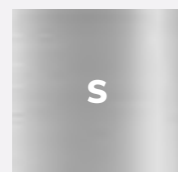

S
Brushed Stainless
Steel



G
Grey Slate BHP

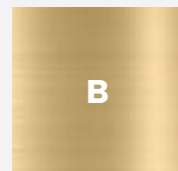

B
Brushed Brass



W
Bengali Mango
Wood BHP

EXAMPLE:

MG CCVR01 WBXX =



H42" ROUND TABLE

CliX H42" | 106cm Base with a Round BHP top.
 Scatter these CliX tables around the venue to present different finger foods and cocktails.

MG CCZR01 GSXX



H42" SQUARE TABLE

CliX H42" | 106cm Base with a Square BHP top.
 Quickly set the atmosphere of any event with these stunning tables.

MG CCZS01 WSXX



H42" RECTANGLE TABLE

CliX H42" | 106cm Base with a Rectangle BHP top.
 The ideal CliX table for larger buffet spreads and food displays.

MG CCZG01 MBXX

DAY & NIGHT

CliX tables can help serve guests by the poolside in the morning, as well as gathering them around elegant bar tables in ballroom evening events.



H30" RECTANGLE TABLE MG CCVG01 WSXX



H42" ROUND TABLE MG CCZR01 MBXX
(shown with optional Round BHP bottom shelf in a Nero Marquina Marble finish)



H42" SQUARE TABLE MG CCZS01 MBXX
(shown with optional Square BHP bottom shelf in a Nero Marquina Marble finish)



TRANSFER & STORAGE CARTS

Mogogo's utility carts are designed for your convenience and mobility and are an integral part of the CliX system as they make storing and assembling the tables easy. Whether it is to pull out the tabletops, to push them through the halls, or get in and out of elevators, they make the behind the scenes of your time-sensitive events easier and give you an extra push on productivity.

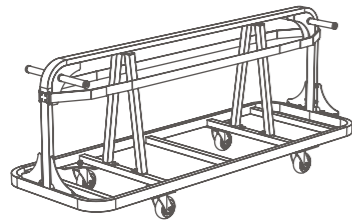

**LARGE PLATE
TRANSFER AND STORAGE CART**
L86.5" W31" H36.5"
L220cm W79cm H92.5cm
holds up to 18 CliX rectangle tops
MG CUUX03 XXXX

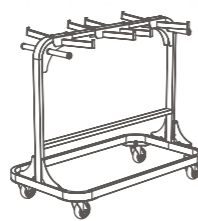

**LEG TRANSFER
AND STORAGE CART**
L55.5" W31" H50"
L141cm W79cm H127.5cm
holds up to 16 folded CliX legs
MG CUUX02 XXXX

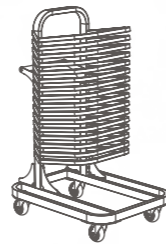

**ROUND / SQUARE TOP
TRANSFER AND STORAGE CART**
L40" W31" H61"
L101cm W79cm H155cm
holds up to 16 CliX round/square tops
MG CUUX04 XXXX

UTILITY CART ADD-ON

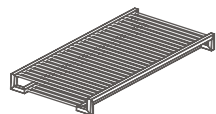

**ROUND / SQUARE TOP CART ADD-ON
SMALL SHELF STORAGE**
L37" W17.5" H3"
L94cm W44cm H7.5cm
Holds a minimum of 16 CliX round/square shelves
MG SADDPS 0201

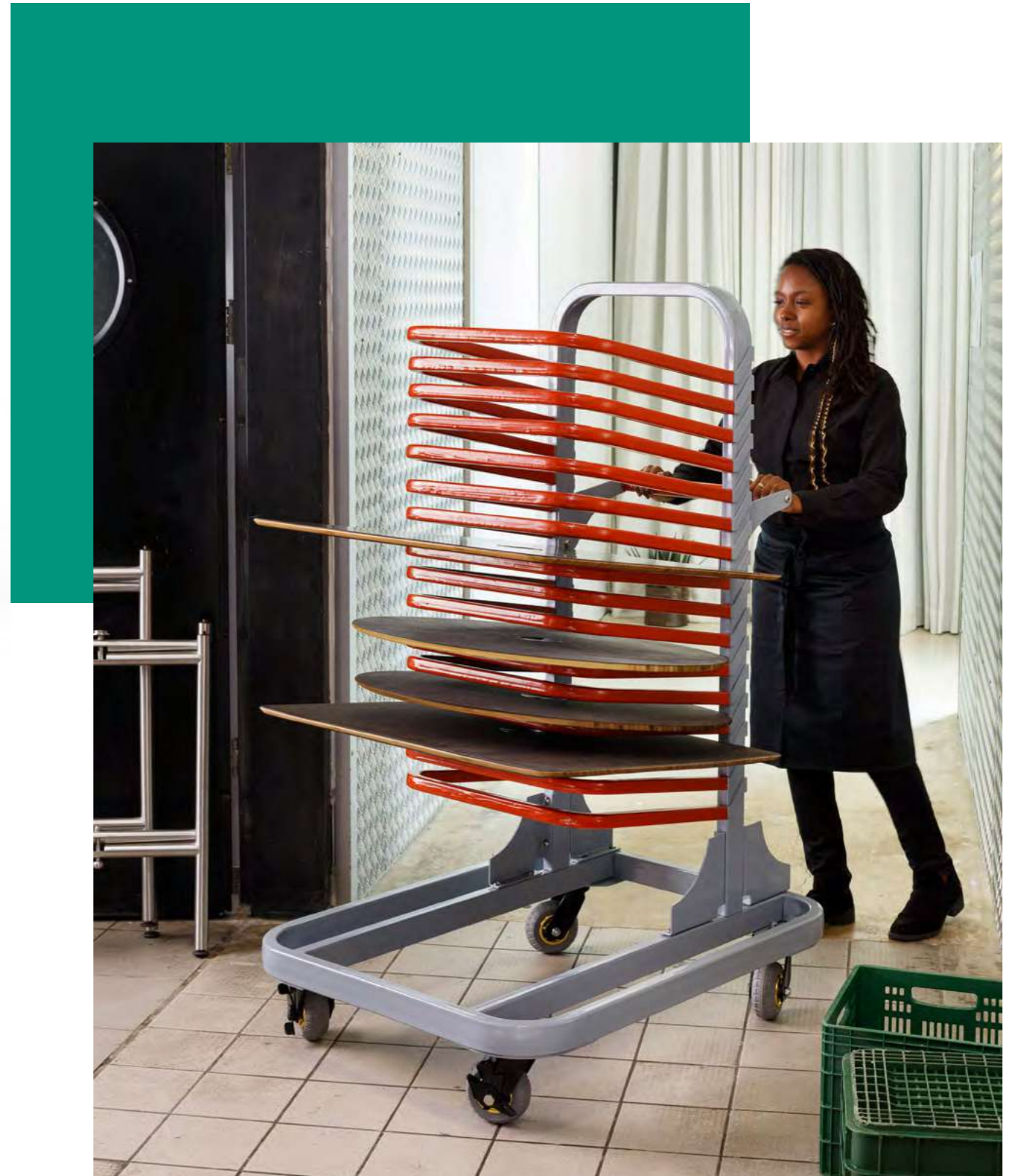

ROUND / SQUARE TOP TRANSFER AND STORAGE CART MG CUUX04 XXXX



SYSTEM BREAKDOWN

Mogogo's CliX Catering Tables Collection offers endless combinations with only two basic elements at its core: Tabletop and Base.

Tabletops are available in three shapes and Three different materials. Table Bases are available in three heights and two stunning finishes. Bottom shelves are available in two shapes to add extra storage or display space.

Delivering on our promise of high functionality and diversity, the CliX Collection reveals a new paramount in product design for hospitality.

mogogo
BUFFET SOLUTIONS



V·Shield
SYSTEM

2022 / 2023



Back to
Catalog
Selection

DISTRIBUTED BY:  **steelite**
INTERNATIONAL

BASES

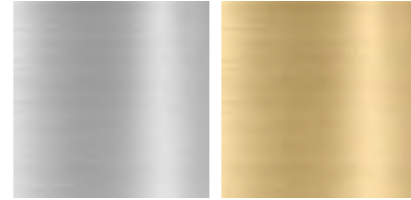

Brushed Stainless Steel

Brushed Brass

MG SCLXSS 0101

MG SCLXBR 0101

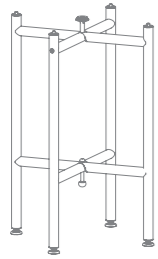

30" BASE
H30" | H76cm

MG SCLXSS 0201

MG SCLXBR 0201

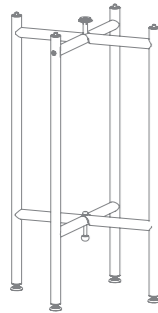

36" BASE
H36" | H91cm

MG SCLXSS 0301

MG SCLXBR 0301

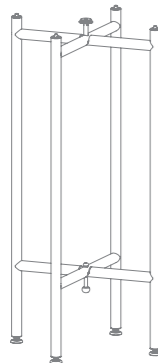

42" BASE
H42" | H106cm

TOPS



Bengali Mango Wood BHP

Grey Slate BHP

Nero Marquina Marble BHP

MG SCXTHW 0101

MG SCXTHG 0101

MG SCXTHB 0101



RECTANGLE BHP TOP
L72" W30" | L182cm W76cm

MG SCXTHW 0201

MG SCXTHG 0201

MG SCXTHB 0201



ROUND BHP TOP
Ø30" | Ø76cm

MG SCXTHW 0301

MG SCXTHG 0301

MG SCXTHB 0301



SQUARE BHP TOP
30" | 76cm

SHELVES

MG SCXBHW 0101

MG SCXBHG 0101

MG SCXBHB 0101



ROUND BHP BOTTOM SHELF
Ø18.5" | Ø47cm

MG SCXBHW 0201

MG SCXBHG 0201

MG SCXBHB 0201

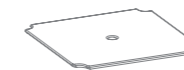

SQUARE BHP BOTTOM SHELF
14" | 36cm



DOUBLE WIDE SHIELD WITH OPENING
MG CDVO03 CSAS

INDEX

- 4 About Mogogo
- 6 About The V-Shield System
- 7 Materials
- 8 How It Works
- 12 Single Shield
- 14 Multiple Shield Configurations
- 18 Unique features
- 19 V-Shield components





A MODERN
FOODSERVICE
FURNITURE BRAND

BORN FROM A PASSION FOR Style & Gastronomy



Mogogo is led by designers and chefs that are aiming to introduce innovative, luxurious, and highly functional equipment to foodservice professionals.

A PERFECT BALANCE
OF LUXURY AND FUNCTION



LINENLESS



MODULAR



MOBILE



SUSTAINABLE



ADD ONS



ABOUT THE V-SHIELD COLLECTION

Mogogo's "Free Standing" V-Shield System was designed for safety, without sacrificing quality and aesthetics.

It can be utilized on most surfaces of any length with adaptive features to turn corners and shield the edges.

The system consists of two different size guards with the option of a full or partially full-length acrylic panel, depending on the specific application.

The V-Shield legs are equipped with magnets, alignment notches and anti-slip pads for additional stability and a clean gap-free appearance.



MATERIALS

The V-Shield System is made of hygienic and durable materials to ensure it holds up under challenging conditions.

- (1) 1/4" (6mm) thick Acrylic Panel
- (2) 1/4" (6mm) thick Stainless Steel Base
- (3) Tailor-made powder coated aluminum profile uprights.

HOW IT WORKS

V-Shields are delivered flat packed and can be assembled in minutes with an Allen Key. With the wide and narrow shields, combined with the corner and end panels, creating a safe and functional configuration for your application has never been easier.

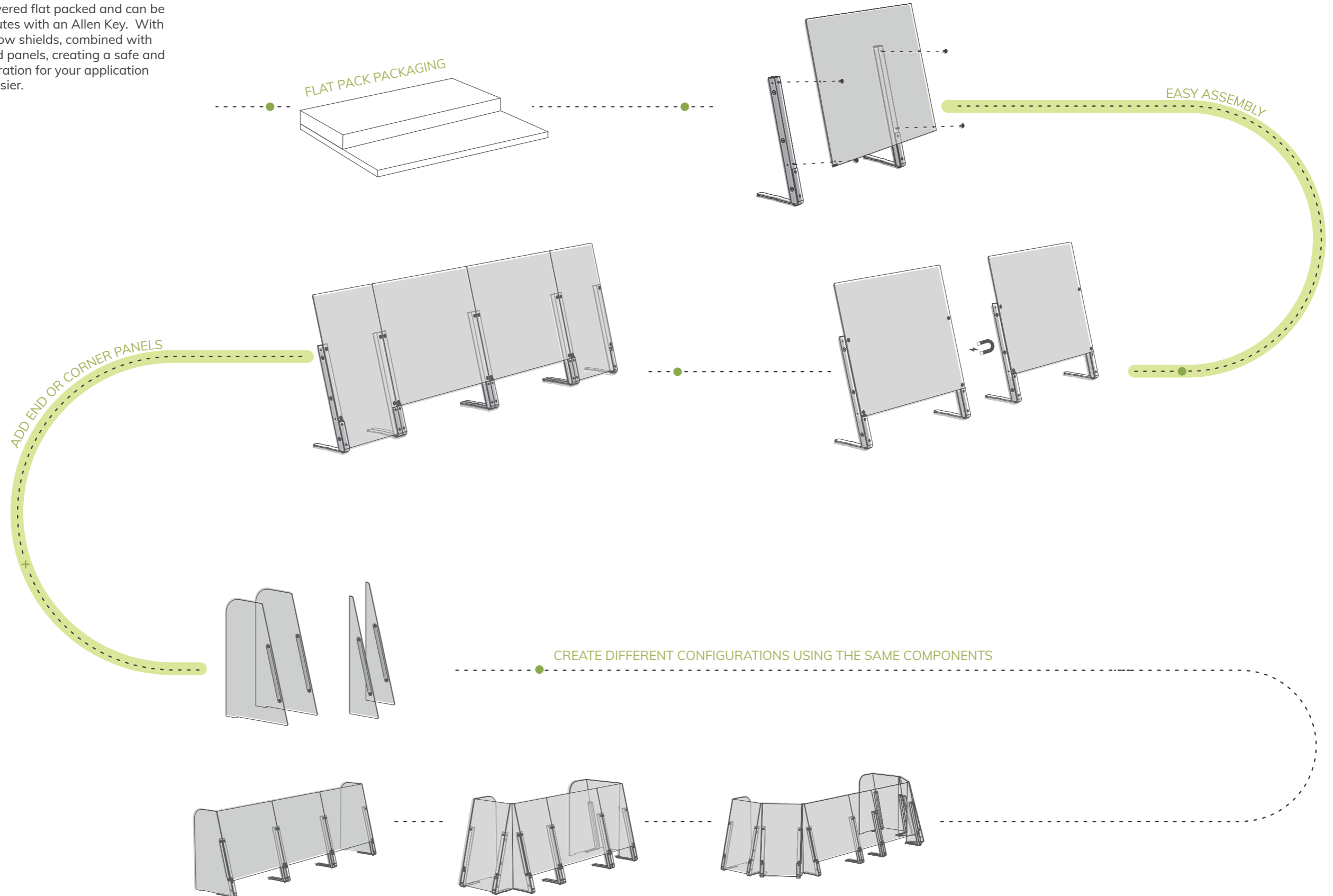



ANTI-SLIP PADS



ALIGNMENT NOTCHES

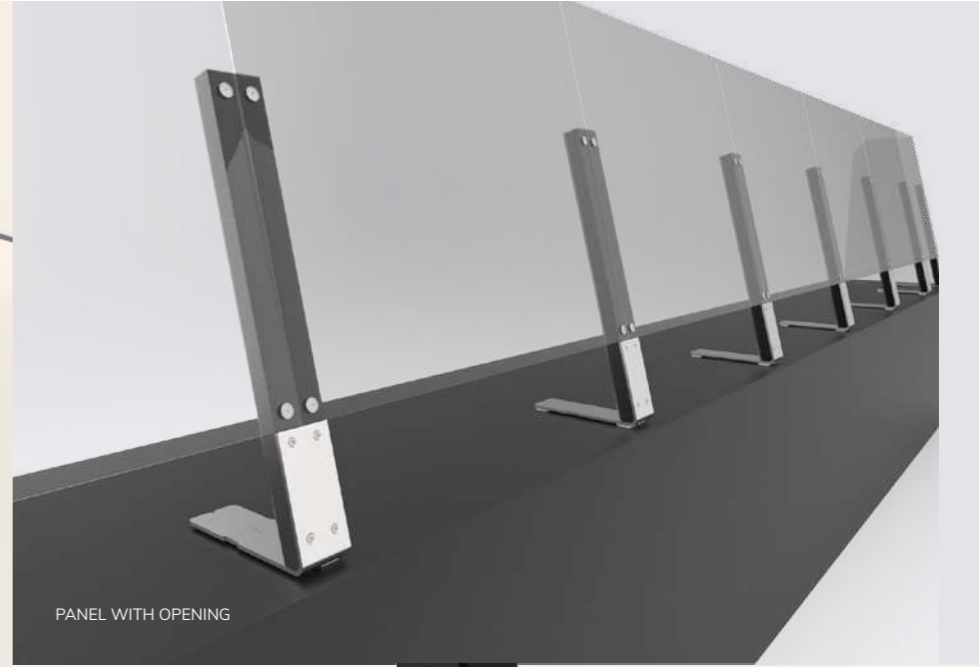

PANEL WITH OPENING

DETAILS



CORNER PANEL



FULL PANEL



GUIDING PINS

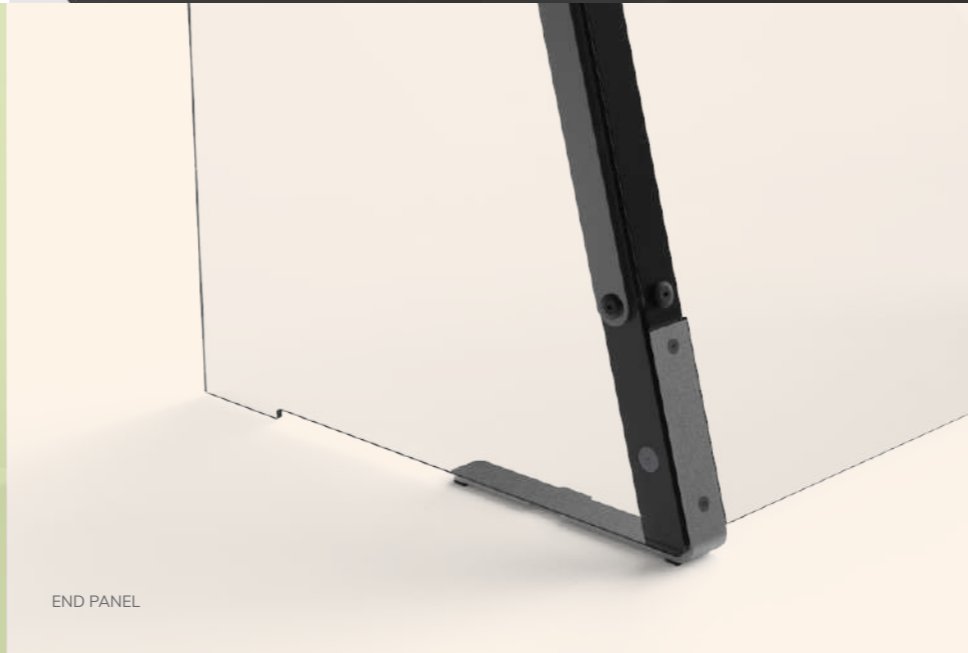

END PANEL

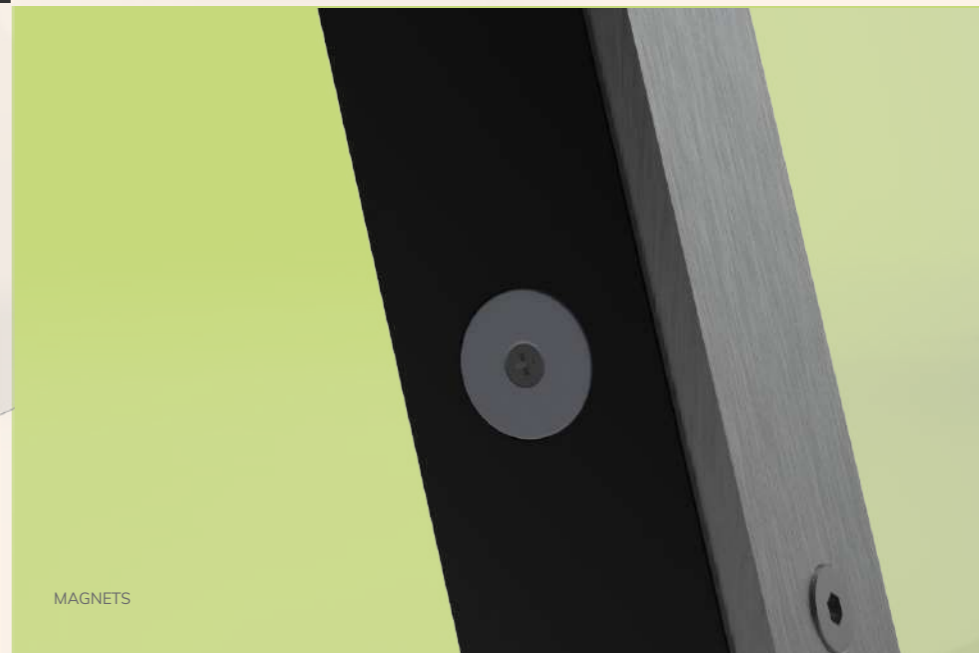

MAGNETS

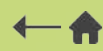



WIDE SHIELD
MGCDVO01CSAS

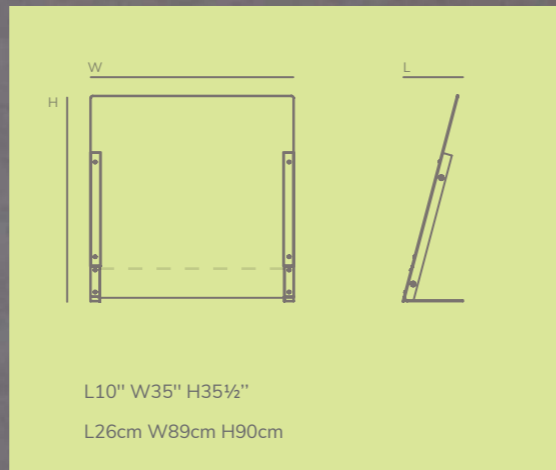

SINGLE WIDE UNITS



WIDE SHIELD
W89cm H90cm | W35" H35½"
MGCDVO01CSAC

WIDE SHIELD WITH OPENING
W89cm H90cm | W35" H35½"
GAP 6" 15cm
MGCDVO01CSAS

SINGLE NARROW UNITS



NARROW SHIELD
W50cm H90cm | W20" H35½"
MGCDVO02CSAC

NARROW SHIELD WITH OPENING
W50cm H90cm | W20" H35½"
MGCDVO02CSAS

MULTIPLE SHIELD CONFIGARATIONS



DOUBLE WIDE SHIELD WITH OPENING
MGCDV003CSAS

DOUBLE CONFIGURATIONS

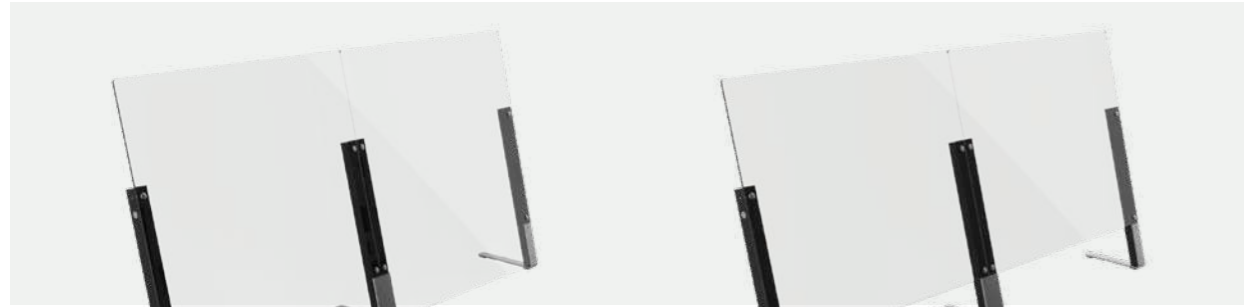

DOUBLE WIDE SHIELD
W178cm H90cm | W70" H35½"
MGCDVO03CSAC
for 6' | 180cm TABLE

DOUBLE WIDE SHIELD WITH OPENING
W178cm H90cm | W70" H35½"
MGCDVO03CSAS
for 6' | 180cm TABLE



DOUBLE WIDE SHIELD WITH OPENING AND END PANELS
W178cm H90cm | W70" H35½"
MGCDVO04CSAS
for 6' | 180cm TABLE

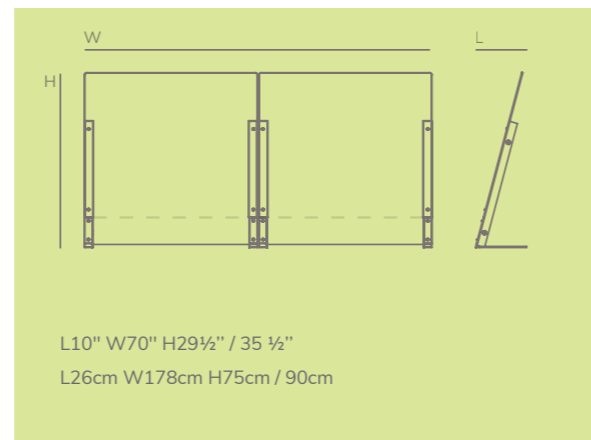

TRIPLE CONFIGURATIONS



EXTRA WIDE SHIELD
W228cm H90cm | W90" H35½"
MGCDVO05CSAC
for 8' | 244cm TABLE

EXTRA WIDE SHIELD WITH OPENING
W228cm H90cm | W90" H35½"
MGCDVO05CSAS
for 8' | 244cm TABLE



EXTRA WIDE SHIELD WITH OPENING AND END PANELS
W228cm H90cm | W90" H35½"
MGCDVO06CSAS
for 8' | 244cm TABLE

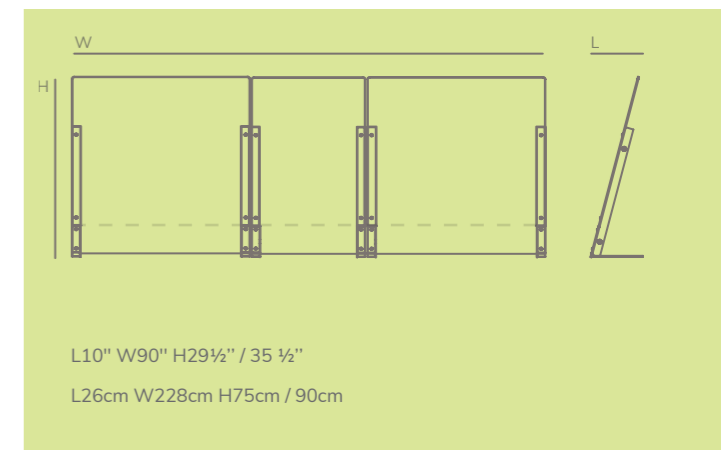

UNIQUE FEATURES

CORNER PANELS

The V-shield corner panels are designed to create configurations that require tight corners or a gentle radius, while maintaining a tight seal.

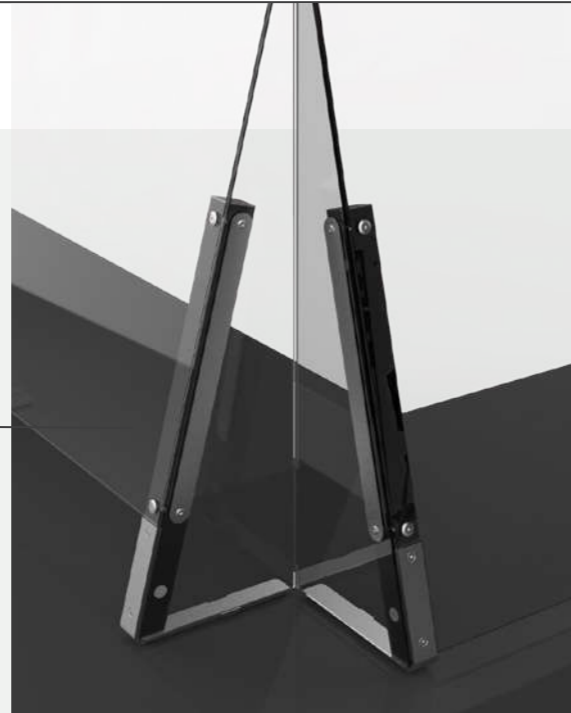

V-SHIELD COMPONENTS

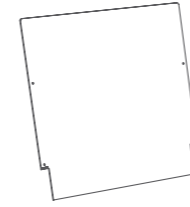

WIDE ACRYLIC PANEL
W89cm H91cm | W35" H36"
MGSVSDPG0101

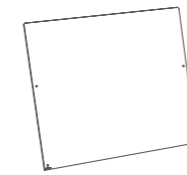

WIDE ACRYLIC PANEL WITH OPENING
W89cm H75cm | W35" H29½"
MGSVSDPG0201



NARROW ACRYLIC PANEL
W50cm H91cm | W20" H36"
MGSVSDPG0301

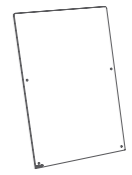

NARROW ACRYLIC PANEL WITH OPENING
W50cm H75cm | W20" H29½"
MGSVSDPG0401



SET OF LEGS
MGSVSDSM0101

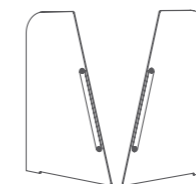

SET OF ACRYLIC END PANELS
MGSVSDSM0301

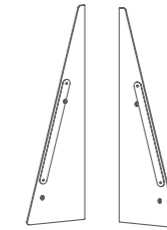

SET OF ACRYLIC CORNER PANELS
MGSVSDSM0201

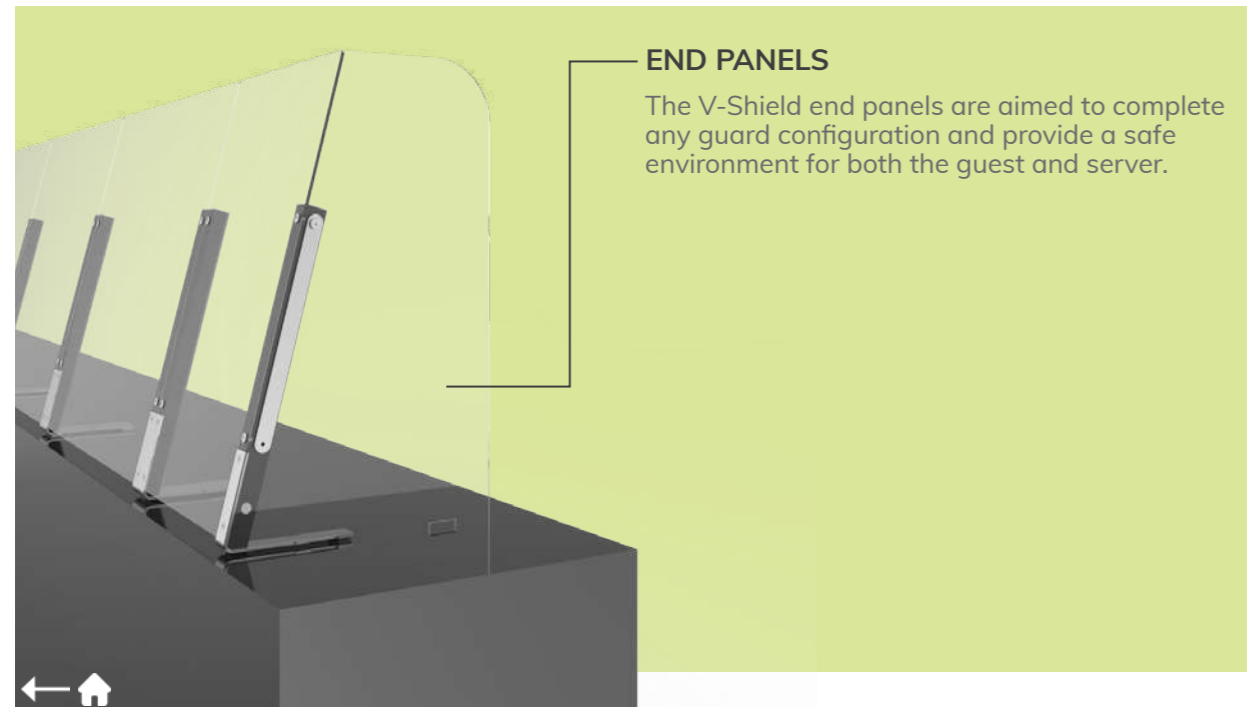

END PANELS

The V-Shield end panels are aimed to complete any guard configuration and provide a safe environment for both the guest and server.



mogogo



Canvas
SHELVING SYSTEM

2022/2023



Back to
Catalog
Selection

DISTRIBUTED BY:  **steelite**
INTERNATIONAL



BASE UNIT WITH CASTERS | HANGER BAR | ANGLED SHELF | CRATE
BOTTLE HOLDER | SHELF | SHELF RETAINING BAR | SHELF WITH BORDER | DIVIDER

INDEX

- 4 About Mogogo
- 8 About the Canvas Collection
- 9 Materials
- 10 How It Works
- 12 Details
- 14 Single unit - basic shelves
- 18 Single unit - mixed add-ons
- 22 Single unit - crates and more
- 28 Multi unit configurations
- 34 System breakdown
- 36 Add-ons
- 40 Express your shelf





A MODULAR F&B
FURNITURE BRAND

BORN FROM A PASSION FOR **STYLE & GASTRONOMY**



Mogogo is led by designers and chefs that are aiming to introduce innovative, luxurious, and highly functional equipment to foodservice professionals.



LINENLESS



MODULAR



MOBILE



SUSTAINABLE



ADD ONS



BACK BAR UNIT MGCCAN05DCXW

MIXOLOGY SERVICE CART MGCRNX03BSXX

ROUND POLO DISPLAY TABLE MGCPPR01MBXX

PRO BAR STATION MGCMLC05GSXW





ABOUT THE CANVAS COLLECTION

The Canvas Collection is an innovative shelving system for the hospitality sector, acting as a blank page allowing professionals to accomplish their creative vision. The collection is ideal as a back bar or for showcasing food and beverages and related products.

It combines function with uncluttered aesthetics to create this versatile range of shelving, taking into consideration the unique and challenging requirements of foodservice.



MATERIALS

The usage of ecological materials is part of a global movement that aims to convey the message that luxury and sustainability go together. The bamboo frame is lightweight and highly structural, joined by decorative metal features to create a fine balance between traditional woodcraft and modern design.

Natural horizontal bamboo | Sandblasted Stainless Steel. NATURAL

Dark brown stained bamboo | Sandblasted Copper-plated Stainless Steel. DARK LUX

HOW IT WORKS

Starting with an unfilled Canvas structure then adding selected fixtures, allows creating stations with specific needs, and the ability to seamlessly connect several units offers the flexibility to construct configurations fitting any size or shape of space.

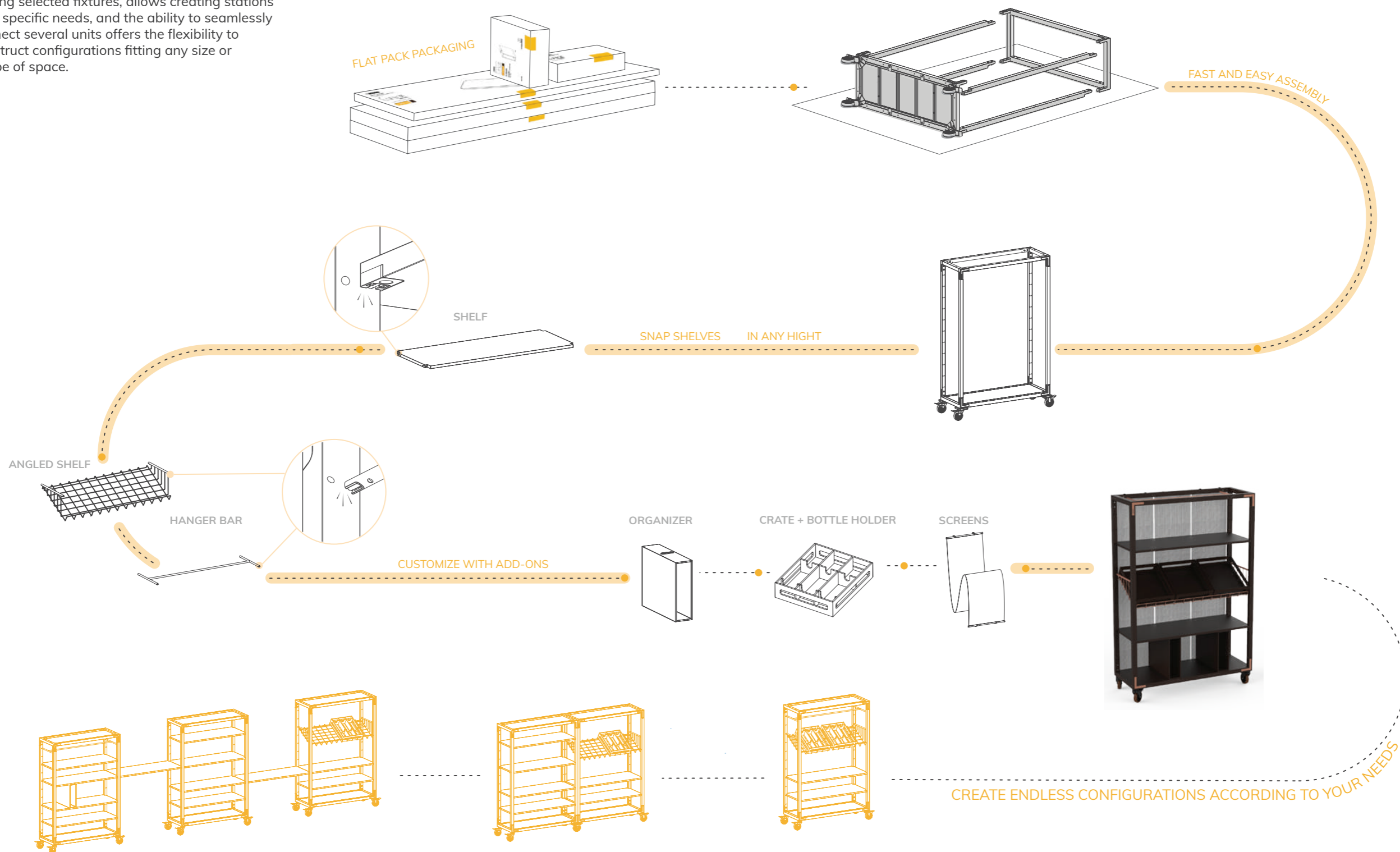

DETAILS

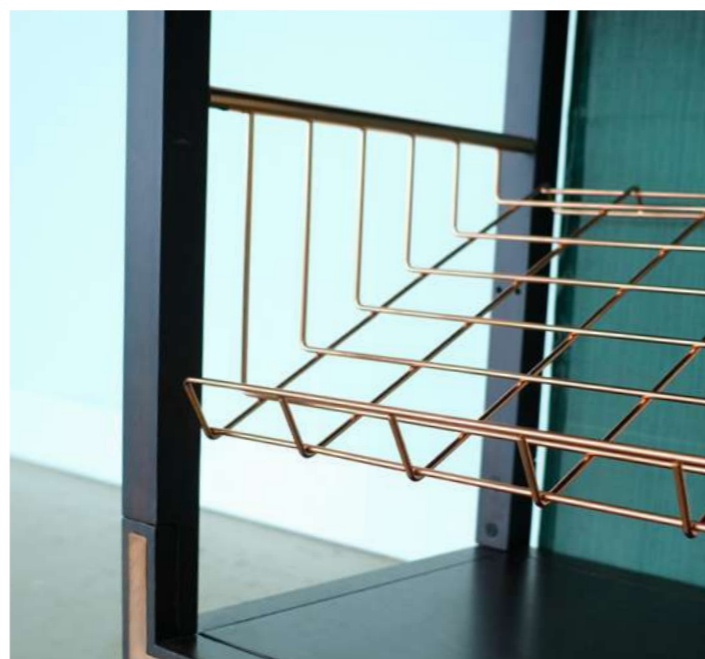
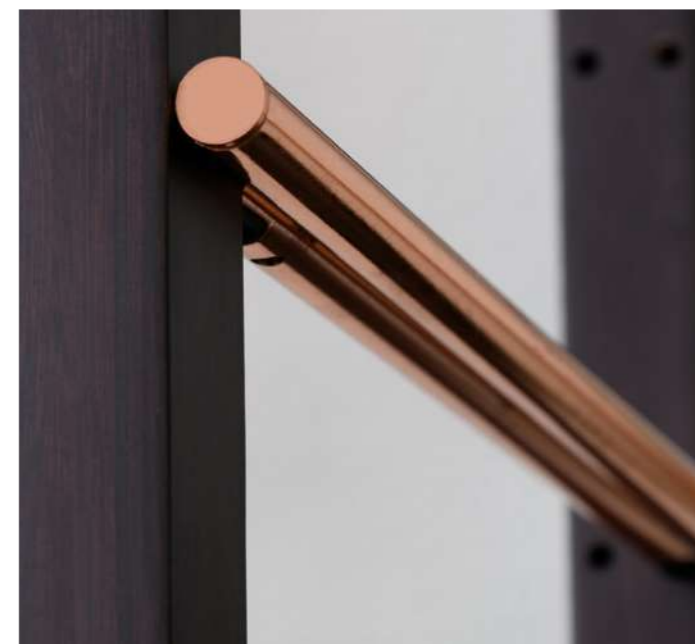
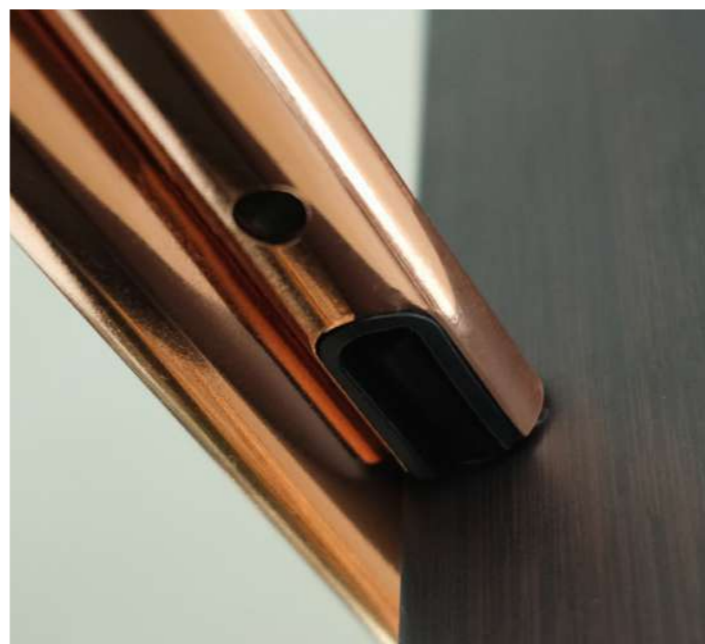



BUSSING STATION MGCCAN14NSXW



SINGLE UNIT - BASIC SHELVES

Organization and accessibility are foundation stones for a functional station. Whether it is used front of house or behind the scenes, several shelves can be set at different heights in a matter of seconds creating a practical and stylish tool. The unit can be covered partially or completely with the use of easy to install screens.

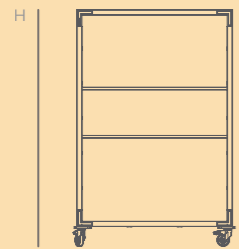
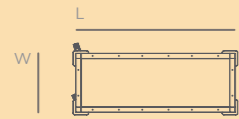

L48½" W18" H73½"
L122.5cm W46cm H186cm



TWO SHELF UNIT

- NATURAL | CASTERS MGCCAN17NSXW
- NATURAL | LEGS MGCCAN17NSXF
- DARK-LUX | CASTERS MGCCAN17DCXW
- DARK-LUX | LEGS MGCCAN17DCXF

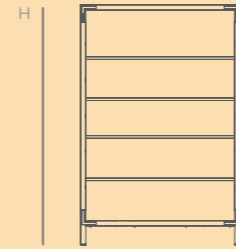
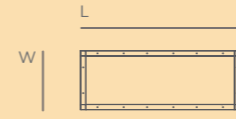

L48½" W18" H73½"
L122.5cm W46cm H186cm



FOUR SHELF UNIT

- NATURAL | CASTERS MGCCAN18NSXW
- NATURAL | LEGS MGCCAN18NSXF
- DARK-LUX | CASTERS MGCCAN18DCXW
- DARK-LUX | LEGS MGCCAN18DCXF

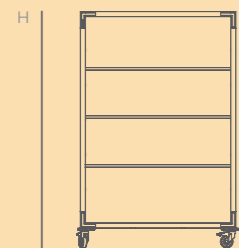
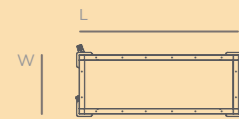

L48½" W18" H73½"
L122.5cm W46cm H186cm



THREE SHELF UNIT

- NATURAL | CASTERS MGCCAN14NSXW
- NATURAL | LEGS MGCCAN14NSXF
- DARK-LUX | CASTERS MGCCAN14DCXW
- DARK-LUX | LEGS MGCCAN14DCXF

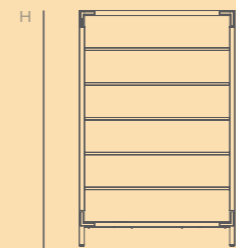
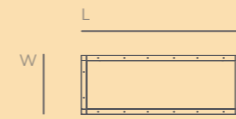

L48½" W18" H73½"
L122.5cm W46cm H186cm



FIVE SHELF UNIT

- NATURAL | CASTERS MGCCAN09NSXW
- NATURAL | LEGS MGCCAN09NSXF
- DARK-LUX | CASTERS MGCCAN09DCXW
- DARK-LUX | LEGS MGCCAN09DCXF

SINGLE UNIT - MIXED ADD-ONS

Mixing and matching is as simple as ever, and while installing the add-ons is user-friendly, the outcome is sophisticated and versatile. The shelf selection and designated add-ons are intended to offer you the freedom of expression when presenting food and beverage or your decoration of choice.



ROOM DIVIDER MGCCAN08DCXW

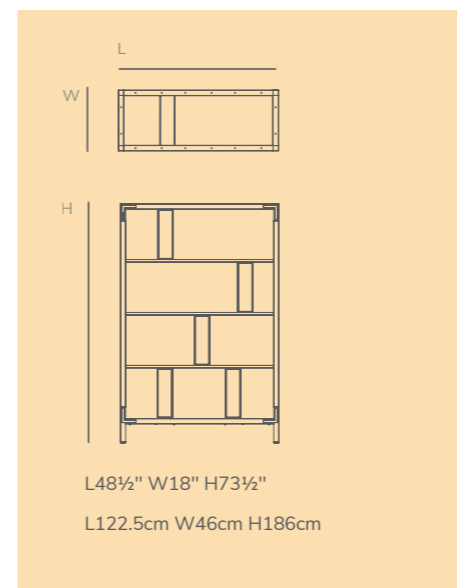
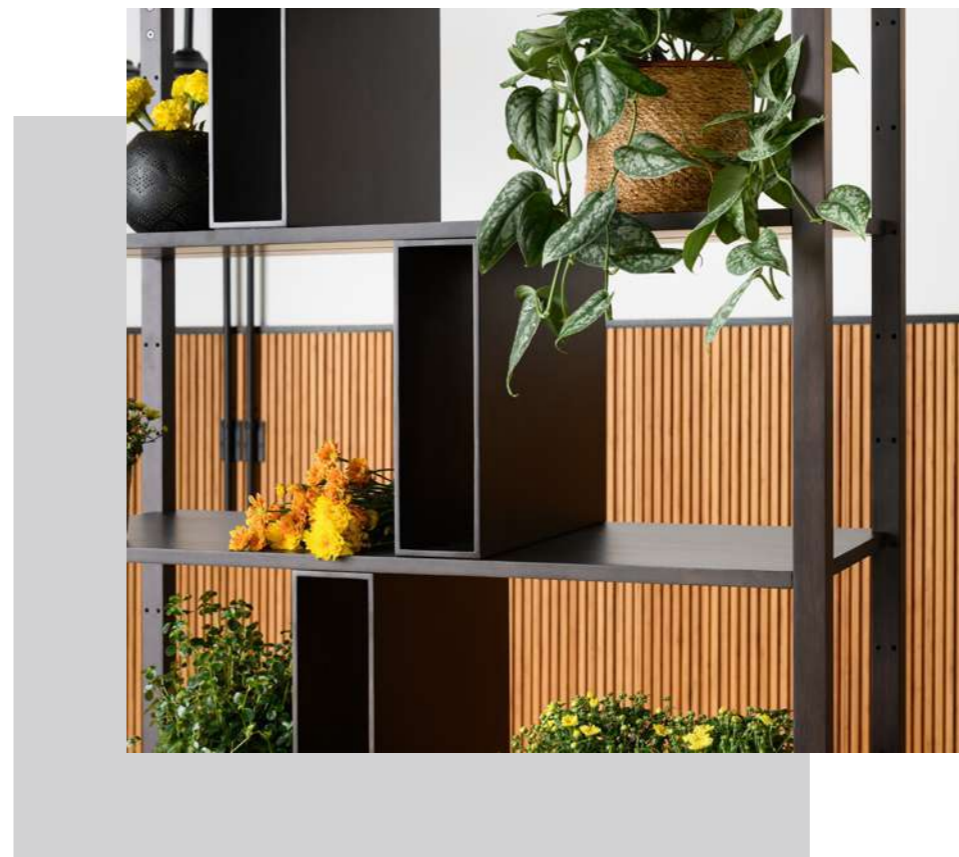

ROOM DIVIDER

This Room Divider creates a sophisticated atmosphere and lining up multiple units can create division and a seamless appearance to any space. The shelf rail allows the dividers to be moved easily while in place to achieve a customized solution for your specific needs.



NATURAL | CASTERS.....MGCCAN08NSXW
NATURAL | LEGS.....MGCCAN08NSXF
 DARK-LUX | CASTERS.....MGCCAN08DCXW
 DARK-LUX | LEGS.....MGCCAN08DCXF



DESSERT STATION

This unit aims to focus attention on selected food items, such as exquisite "petit fours" or other food creations you wish to treat and showcase as jewels. It comes with two shelves and a slick sign to let your guests know what all the fuss is about.

- **NATURAL | CASTERS**.....MGCCAN15NSXW
- NATURAL | LEGS.....MGCCAN15NSXF
- DARK-LUX | CASTERS.....MGCCAN15DCXW
- DARK-LUX | LEGS.....MGCCAN15DCXF

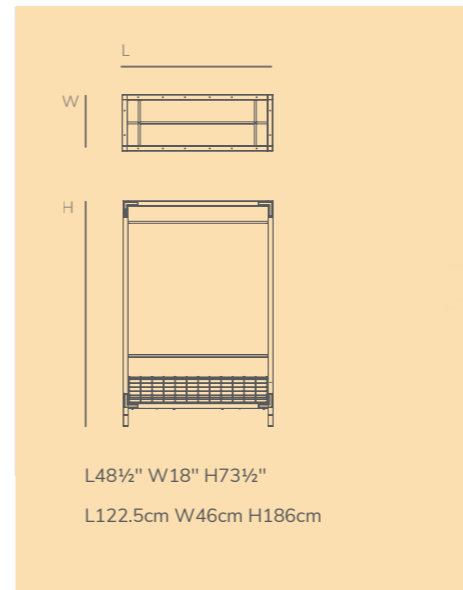

COAT RACK

The Canvas system function can be stretched beyond the common usage to other hospitality areas, such as this portable coat rack station and many others, helping to overcome your daily challenges.

- NATURAL | CASTERS.....MGCCAN11NSXW
- NATURAL | LEGS.....MGCCAN11NSXF
- DARK-LUX | CASTERS.....MGCCAN11DCXW
- **DARK-LUX | LEGS**.....MGCCAN11DCXF

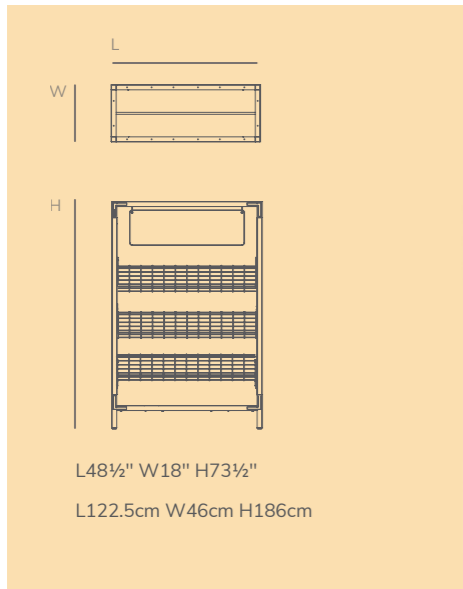

ANGLED SHELF SIGNAGE UNIT

This unit takes food presentation seriously! The angled stainless steel wire shelf offers food and related ingredients to be presented in an optimal style, and the hanging blackboard sign allows you to compose a unique story time after time.

- NATURAL | CASTERS.....MGCCAN16NSXW
- **NATURAL | LEGS**.....MGCCAN16NSXF
- DARK-LUX | CASTERS.....MGCCAN16DCXW
- DARK-LUX | LEGS.....MGCCAN16DCXF

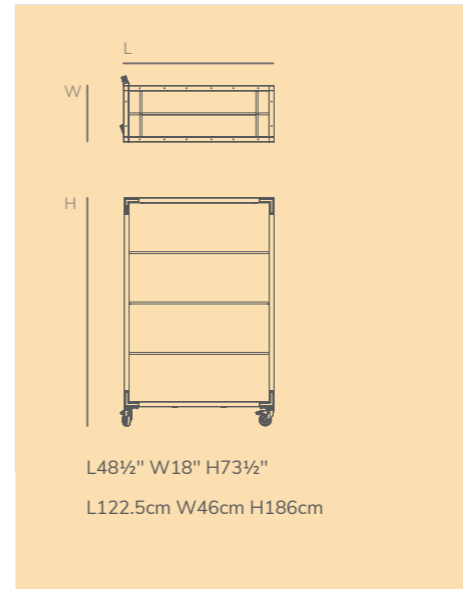

HANGING UNIT

A clean and mentalistic hanging station offers to use the Canvas in exacting ways and discover new ideas to wow your guests, such as an indoor vertical herb garden or other ideas that you will come up with.

- NATURAL | CASTERS.....MGCCAN10NSXW
- NATURAL | LEGS.....MGCCAN10NSXF
- **DARK-LUX | CASTERS**.....MGCCAN10DCXW
- DARK-LUX | LEGS.....MGCCAN10DCXF



GRAB AND GO SIGNAGE UNIT MGCCAN03NSXW



SINGLE UNIT - CRATES AND MORE

This group of configurations is defined by the crates they hold, allowing the operator to store and display most anything they wish. Combined with shelving and signage, they can perform many functions in a variety of locations while offering versatility and beauty.

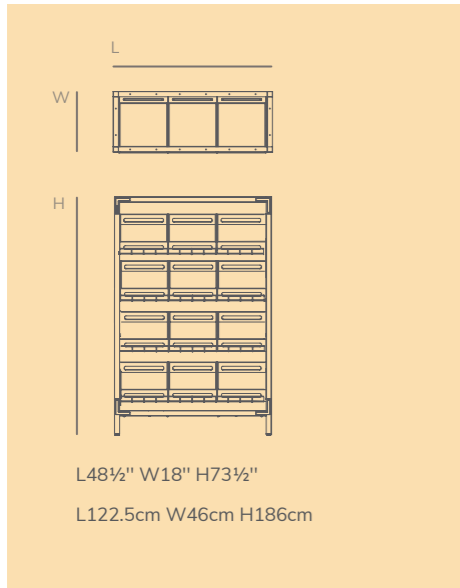

ANGLED SHELF UNIT

The wooden display crates with fresh vegetables, breads, combined with the olive oil bottles, bags of flour and other quality ingredients, are sure to tell your guest that a wonderful dish is on the way. Ultimately, completing the sensory experience that is so essential in hospitality!

- **NATURAL | CASTERS**.....MGCCAN12NSXW
- NATURAL | LEGS.....MGCCAN12NSXF
- DARK-LUX | CASTERS**.....MGCCAN12DCXW
- DARK-LUX | LEGS.....MGCCAN12DCXF

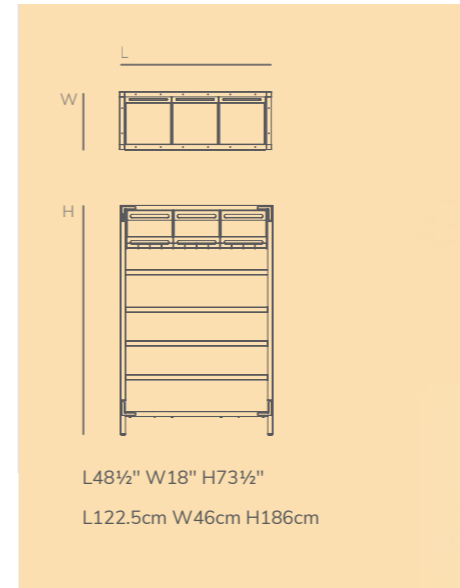

GRAB AND GO UNIT

Snacks, fruit and a variety of goods your guests desire to Grab and Go, will be displayed perfectly on this Canvas configuration. The angled shelf will improve visibility and create a complete experience.

- NATURAL | CASTERS.....MGCCAN02NSXW
- NATURAL | LEGS.....MGCCAN02NSXF
- DARK-LUX | CASTERS.....MGCCAN02DCXW
- **DARK-LUX | LEGS**.....MGCCAN02DCXF

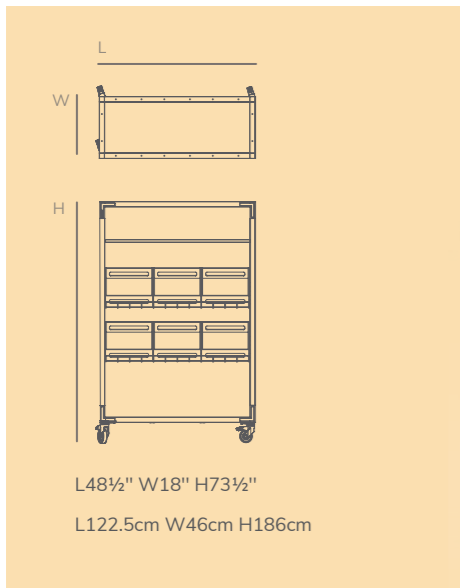

FARM TO TABLE

What is more appetizing than knowing that what you are about to eat is made from farm fresh ingredients. This Farm to Table Station was developed with this in mind and provides you a variety of display solutions that can effortlessly be customized according to the menu.

- NATURAL | CASTERS.....MGCCAN04NSXW
- NATURAL | LEGS.....MGCCAN04NSXF
- **DARK-LUX | CASTERS**.....MGCCAN04DCXW
- DARK-LUX | LEGS.....MGCCAN04DCXF

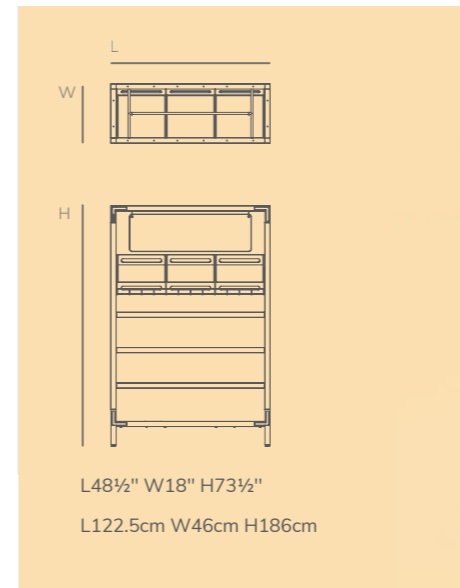

GRAB AND GO SIGNAGE UNIT

Like the Grab and Go unit above, it has the angled shelf, but also includes a chalkboard to make it very clear to your guests that tasty treats are available.

- NATURAL | CASTERS.....MGCCAN03NSXW
- **NATURAL | LEGS**.....MGCCAN03NSXF
- DARK-LUX | CASTERS.....MGCCAN03DCXW
- DARK-LUX | LEGS.....MGCCAN03DCXF



FARM TO TABLE MGCCAN04DCXW
THREE SHELF UNIT MGCCAN14NSXW
GRAB AND GO SIGNAGE UNIT MGCCAN03NSXW





CENTER STAGE DISPLAY MGCCAN19NSXW
 (Shown with optional Golden-Brown screens)

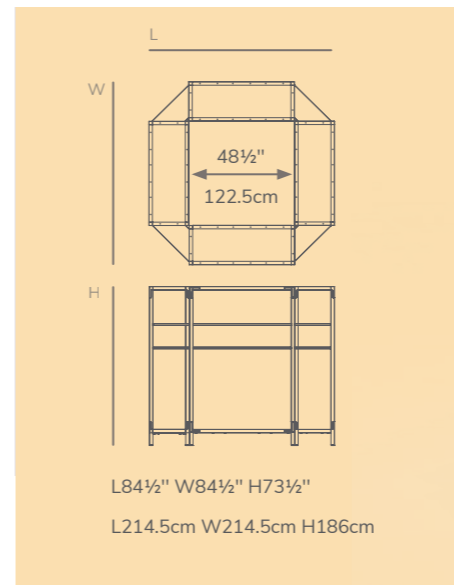

CENTER STAGE DISPLAY

Whether you're trying to make a statement in the middle of your room or wanting to utilize the space around that awkward pillar, this station will do both. The ability to connect the Canvas shelving units with the corner shelf connectors adds a dimension the traditional buffet furniture lacks and the results can be functional and stunning.

- NATURAL | CASTERS.....MGCCAN19NSXW
- NATURAL | LEGS.....MGCCAN19NSXF
- DARK-LUX | CASTERS.....MGCCAN19DCXW
- DARK-LUX | LEGS.....MGCCAN19DCXF

MULTI UNIT CONFIGURATIONS

If your space allows the use of several units, the addition of the unit connectors, straight shelves and corner shelves, is a cost effective way to add additional display space. In addition, it creates straight or angled structures that act as living walls, allowing you to express your artistic talents.

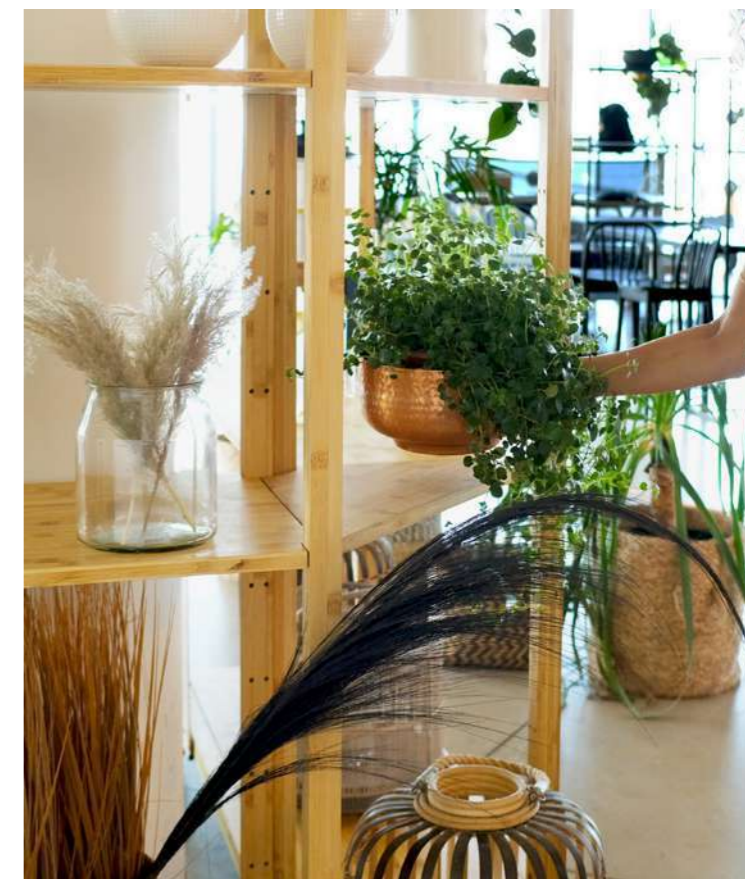

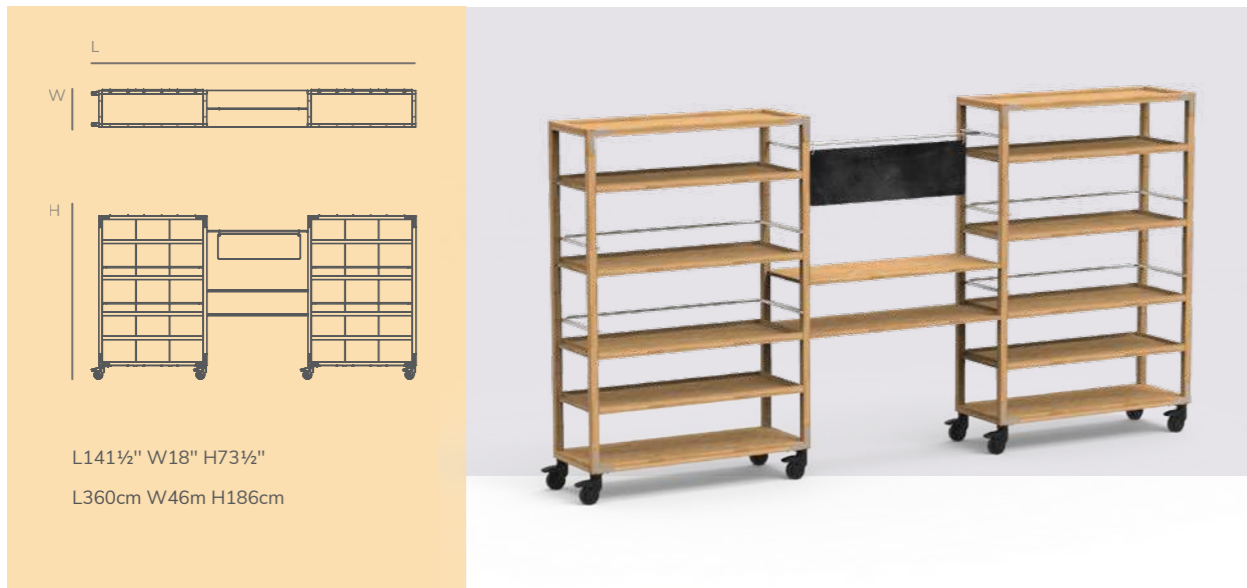

BACK BAR UNIT

A luxurious back bar tells a story and lets your guest know that they have arrived at their destination and will be treated accordingly. Whether they seek a revitalizing cocktail or a glass of wine, the look and feel you create will set the tone.

■ NATURAL CASTERS	MGCCAN05NSXW
NATURAL LEGS	MGCCAN05NSXF
■ DARK-LUX CASTERS	MGCCAN05DCXW
DARK-LUX LEGS	MGCCAN05DCXF



COFFEE LOUNGE

Double espresso, butter Croissant, and the newspaper of the day! No matter where you wake up, it's a great way to start another busy day. The flexibility of the Canvas Collection can turn your pleasant but hard to utilize space into an attractive area that gives a look and feel of a neighborhood café.

NATURAL CASTERS	MGCCAN07NSXW
NATURAL LEGS	MGCCAN07NSXF
DARK-LUX CASTERS	MGCCAN07DCXW
■ DARK-LUX LEGS	MGCCAN07DCXF

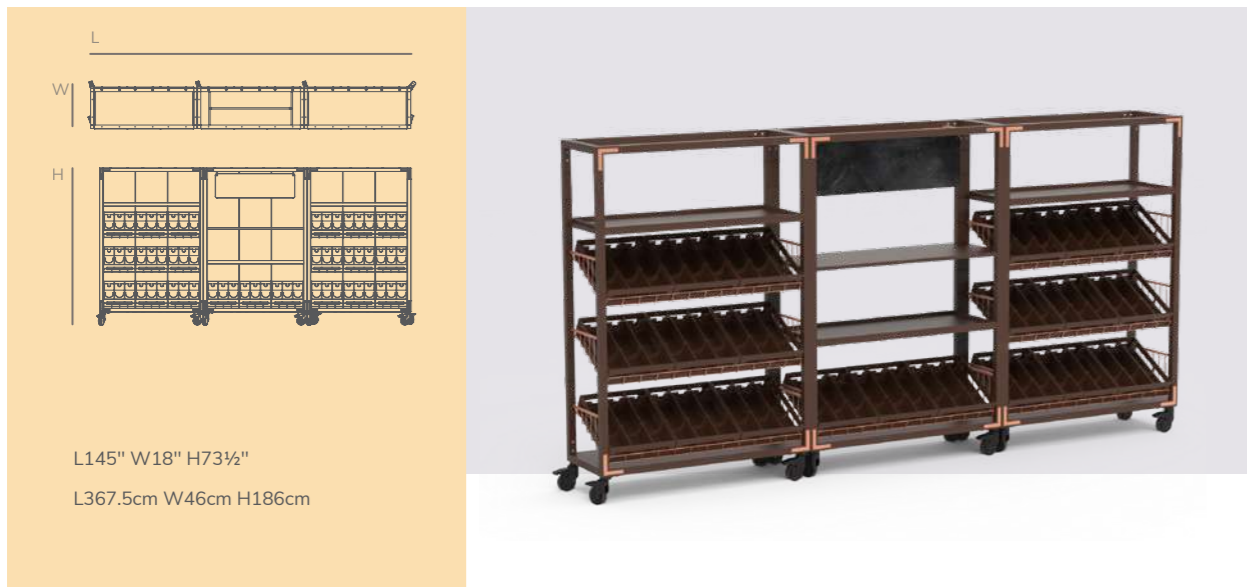

WINE DISPLAY

At the end of the day, a glass of red wine, cheese, and snacks can turn into a worthy memory. This elegant configuration allows for the serving of wine and related foods in a way that is sure to impress. Each unit comes with casters allowing for easy mobility when moving from one event to another.

NATURAL CASTERS	MGCCAN06NSXW
NATURAL LEGS	MGCCAN06NSXF
■ DARK-LUX CASTERS	MGCCAN06DCXW
DARK-LUX LEGS	MGCCAN06DCXF



SELF SERVICE

Juice boxes or sweets? What decorations will enhance the experience to create something modern and minimalist, or a warmer and more country style. The self service configuration gives you the tools to express your desired concept no matter what the occasion is.

■ NATURAL CASTERS	MGCCAN01NSXW
NATURAL LEGS	MGCCAN01NSXF
DARK-LUX CASTERS	MGCCAN01DCXW
DARK-LUX LEGS	MGCCAN01DCXF

CDG	245 - 244	CHECK-IN
CX	0708	204 - 247
CZ	7122	2 KIOSK
DY	3581	2 KIOSK
EI	0645	1
EK	0140	1 171 - 178
CHECK-IN		



COFFEE LOUNGE MGCCAN07DCXW
(shown with optional Charcoal-Black Screens)

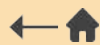



MGCCAN04DCXW

SYSTEM BREAKDOWN

Starting with a blank rectangular structure (on casters or legs) acting as an empty page that awaits your ideas and needs to be explored. Our Canvas Shelving System was born from the basic idea that your F&B Furniture should adapt to your ever-varying needs during different functions. It allows you to pick and choose basic elements such as shelves with or without borders, hanging bars, signs, organizers, and more.

BUILD YOUR OWN UNITS

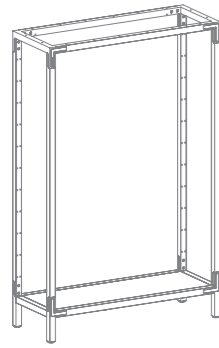

EMPTY UNIT WITH LEGS
L48½" W18" H73½"
L122.5cm W46cm H186cm



Natural horizontal bamboo sandblasted stainless steel

MGCCAN13NSXF



Dark brown stained bamboo Sandblasted Copper plating

MGCCAN13DCXF

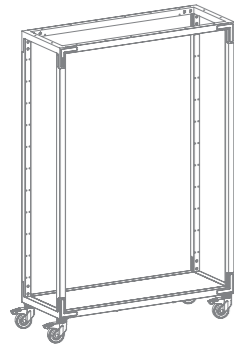

EMPTY UNIT WITH CASTERS
L48½" W18" H73½"
L122.5cm W46cm H186cm

MGCCAN13NSXW

MGCCAN13DCXW

ADD-ONS SHELVES



Natural horizontal bamboo sandblasted stainless steel

MGSCANBM0201



Dark brown stained bamboo Sandblasted Copper plating

MGSCANDB0201



SHELF
L46½" W18" H0.8"
L118.5cm W46cm H2cm



SHELF WITH BORDER
L46½" W18" H1½"
L118.5cm W46cm H4cm

MGSCANBM0701

MGSCANDB0701



TOP FRAME SHELF
L45" W15" H0.8"
L114.5cm W38cm H2cm

MGSCANBM0601

MGSCANDB0601

ADD-ONS



Natural horizontal bamboo sandblasted stainless steel

MGSCANSS0101



Dark brown stained bamboo Sandblasted Copper plating

MGSCANSC0101



HANGER BAR
Comes with 5 Hooks
L46½" W15" H½"
L118cm W38cm H1.6cm



TOP FRAME HANGER BAR
Comes with 5 Hooks
L38" W16½" H½"
L96cm W41.5cm H1.5cm

MGSCANSS0201

MGSCANSC0201

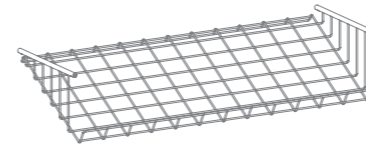

ANGLED SHELF
Can fit up to 3 crates
L46½" W18" H9½"
L118cm W46cm H24cm

MGSCANSS0301

MGSCANSC0301



SHELF RETAINING BAR
L46½" W18" H0.6"
L118cm W46cm H1.6cm

MGSCANSS0401

MGSCANSC0401

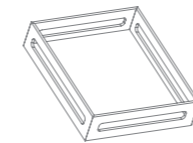

CRATE
L17½" W14.½" H4"
L44cm W37.5cm H10cm

MGSCANBM0301

MGSCANDB0301

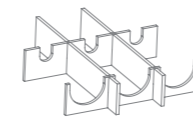

BOTTLE HOLDER
fits Crate
L16½" W14" H3½"
L42.5cm W36cm H8.5cm

MGSCANBM0401

MGSCANDB0401

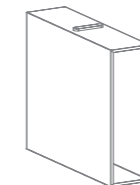

ORGANIZER
L18" W4½" H15½"
L46cm W12cm H39cm

MGSCANBM0501

MGSCANDB0501

ADD-ONS

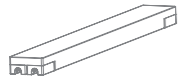

UNIT CONNECTORS
To connect two units | Set of 2
L15" W1.5" H0.8"
L38cm W4cm H2cm



Natural horizontal
bamboo sandblasted
stainless steel

MGSCANBM0901



Dark brown stained
bamboo Sandblasted
Copper plating

MGSCANDB0901



CORNER SHELF CONNECTOR
To connect two units in 90° | Set of 2
L18" W18" H0.8"
L46cm W46cm H2cm

MGSCANBM1101

MGSCANDB1101

MISCELLANEOUS ADD-ONS

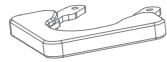

BUMPERS
set of 4
L5" W5" H0.6"
L12cm W12cm H1.6cm

MGSCANSM0801

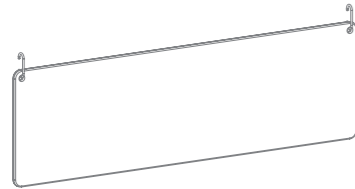

SIGN
Comes with 2 Hooks
L37" W11½" H½"
L94cm W29cm H1cm

MGSCANSM0901

SCREENS

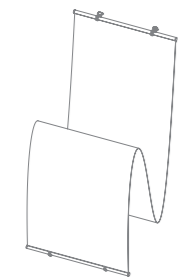

EASY TO INSTALL SCREENS
Set of 5- Available in various colors
L67" W15"
L170cm W38cm

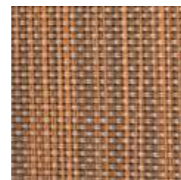

Golden-Brown

MGSCANPV0201



Jungle-Green

MGSCANGP0101

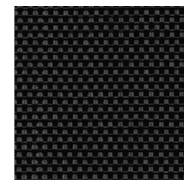

Charcoal-Black

MGSCANPV0101



COAT RACK MGCCAN11NSXW

Sketch your own Canvas configuration by choosing from a variety of shelves and add-ons using the 2D drawing to explore options.

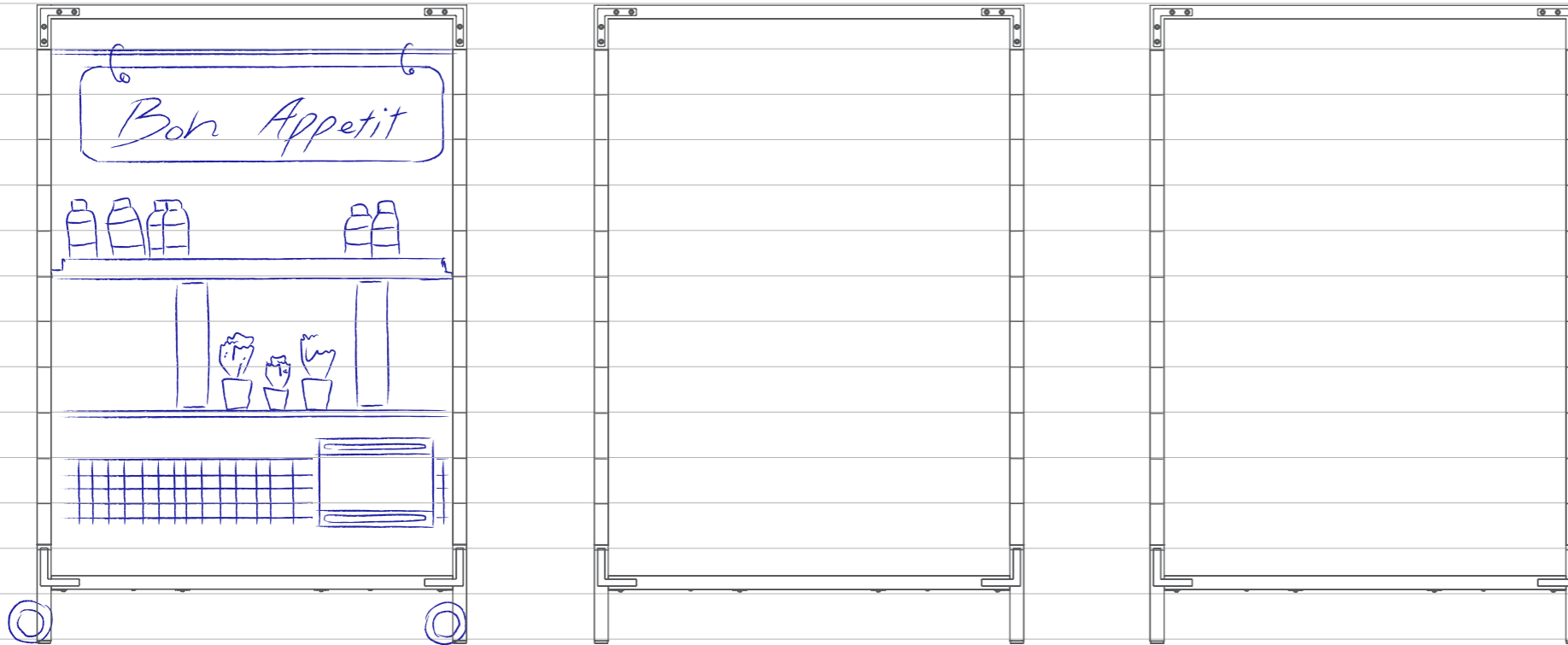

- TOP FRAME SHELF 
- SHELF 
- ANGLED SHELF 
- SHELF WITH BORDER 
- SHELF RETAINING BAR 
- SIGN 
- TOP FRAME HANGER BAR 
- HANGER BAR 
- CRATE 
- BOTTLE HOLDER 
- BUMPERS 
- ORGANIZER 

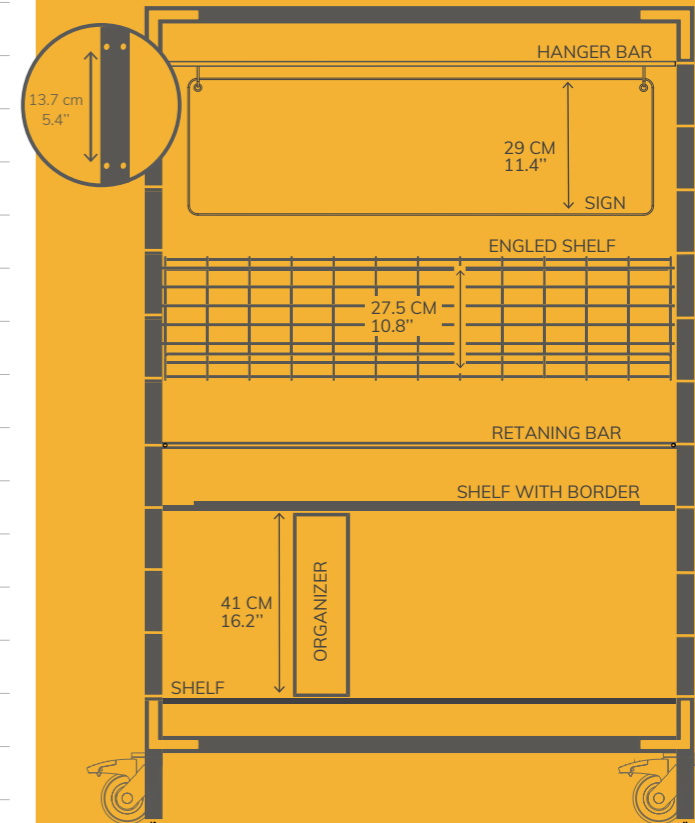
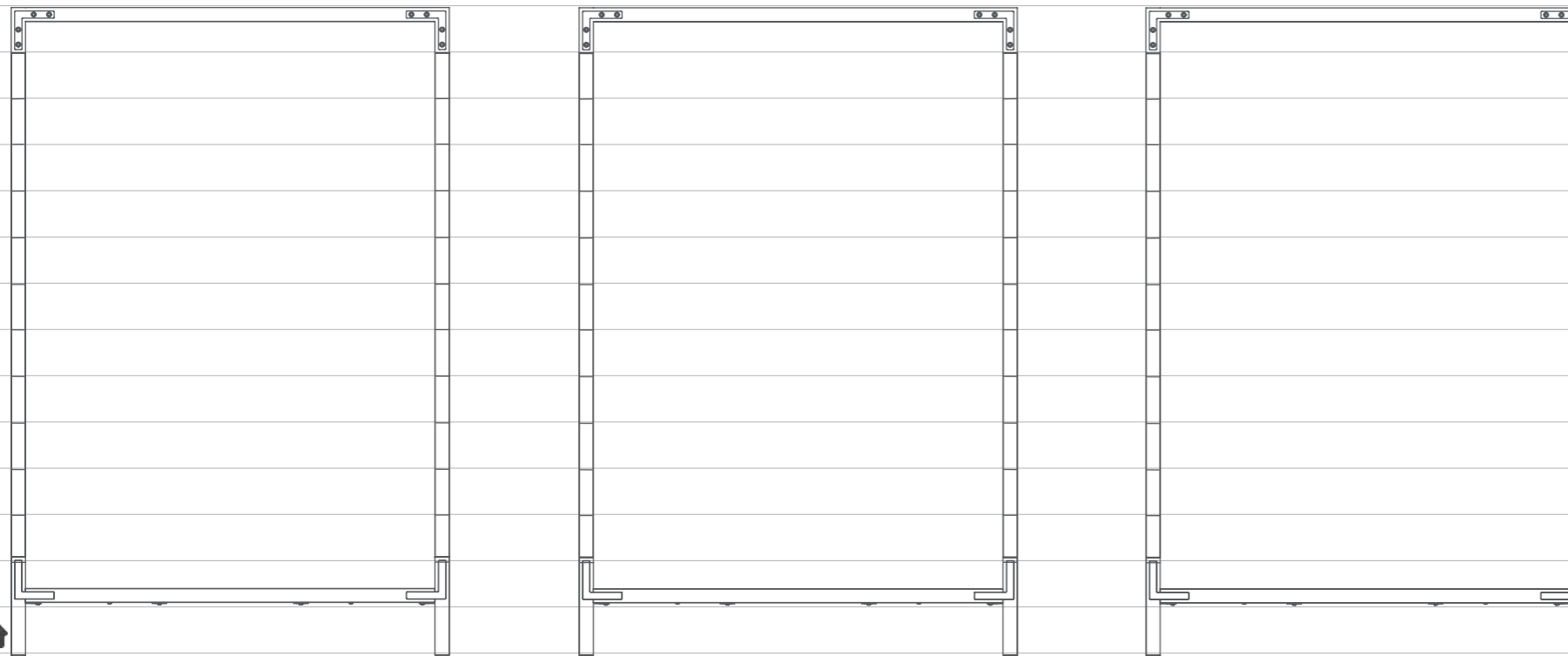



BUFFET SOLUTIONS

www.mogogo-buffet.com

info@mogogo-buffet.com



Modular
SYSTEM



Roll'n
SERVICE CARTS



Polo
TABLES



Clix
TABLES

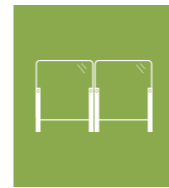

V-Shield
SYSTEM



Canvas
SHELVING SYSTEM

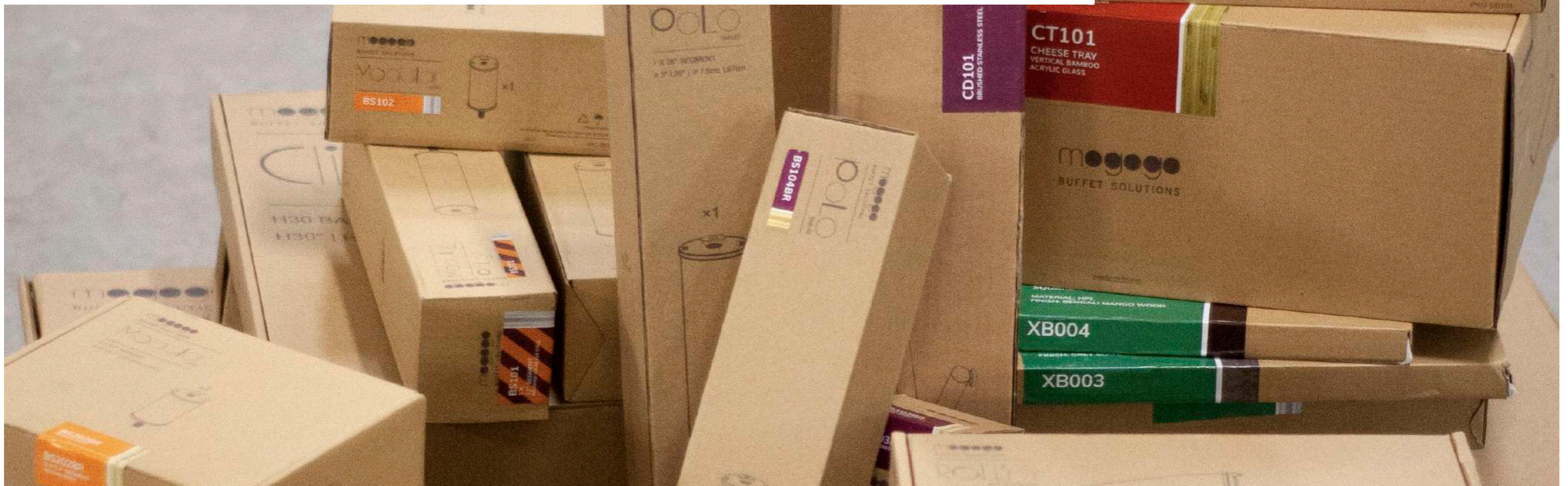



BUFFET SOLUTIONS

www.mogogo-buffet.com
info@mogogo-buffet.com



www.steelite.com
facebook.com/steeliteinternationalEMEA
twitter.com/SteeliteEMEA
instagram.com/steelite_emea

United Kingdom &
Republic of Ireland
Steelite International Ltd
Orme Street
Stoke-on-Trent
ST6 3RB
England

UK Distribution Centre
Steelite International Ltd
Station Street
Stoke-on-Trent
ST6 4NB
England
Telephone +44 (0)1782 821 000
Fax +44 (0)1782 819 926
Email headoffice@steelite.com

London Showroom
Steelite International Ltd
75 Wells Street
2nd Floor South
London
W1T 3QH
Telephone +44 (0)1782 249 599
Email london@steelite.com



Modular
SYSTEM



Roll'n
SERVICE CARTS

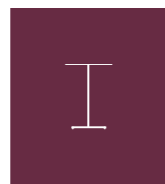

PoLo
TABLES



Clix
TABLES

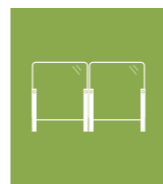

V-Shield
SYSTEM



Canvas
SHELVING SYSTEM

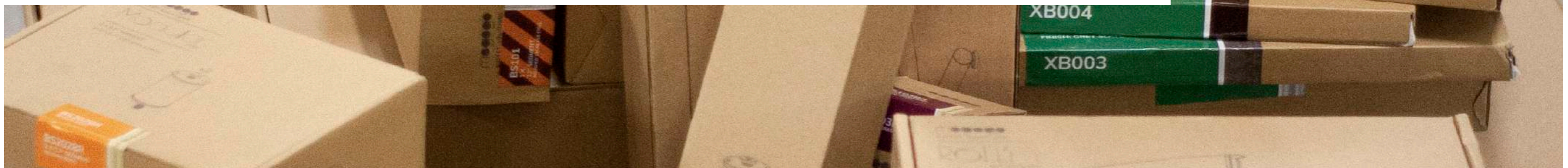



www.mogogo-buffet.com
info@mogogo-buffet.com



www.steelite.com
facebook.com/steeliteinternationalEMEA
twitter.com/SteeliteEMEA
instagram.com/steelite_emea

www.steelite.com

America
154 Keystone Drive
New Castle, Pennsylvania 16105
toll free: 800-367-3493
Telephone: 724-856-4900
Fax: 724-856-7925
Email: usa@steelite.com

Canada
Unit 2, 26 Riviera Drive Markham,
Ontario L3R 5M1
Toll Free: 800-465-4284
Telephone: 905-752-1074
Fax: 905-752-1120
Email: canada@steelite.com

United Kingdom & Republic of Ireland Steelite
International Ltd Orme Street
Stoke-on-Trent ST6 3RB
England
Telephone: +44 (0)1782 821 000
Fax: +44 (0)1782 819 926
Email: headoffice@steelite.com

Showrooms available by appointment:
Atlanta • Chicago • Cincinnati • Las Vegas
London, UK • Los Angeles • New York
Stoke-on-Trent • Toronto,

