

**kettal**





4–5	Index
6–7	Kettal
8–13	Pavilion O
14–21	Officescape
22–41	Focus
42–65	Meeting rooms
66–93	Hub

94 – 113	Support
114 – 129	Specifications
130 – 153	Lighting
154 – 189	Furniture
190 – 215	Materials
216 – 219	Environment
220	Credits

Kettal is a family business established in Europe in 1966.





All of our products are manufactured 45km from Barcelona in a small coastal town. We pride ourselves on our European made quality. In-house manufacturing allows us to pay close attention to detail and gives us the ability to meet our clients' customization requirements, making each piece of Kettal furniture unique and exclusive.

The importance of research – both scientific and technological – has always been at the forefront of our product development. The high-quality products we offer today are the result of our spirit of innovation.

We have our own state of the art manufacturing plant where the product is designed, manufactured and tested locally.

Our manufacturing processes involve intense manual labor and 85% of Kettal products are handmade. Our handmade ethos means that we build strong yet beautiful Kettal pieces that display an exquisite attention to detail.

# Pavilion O, a modular structure to reinvents the workplace.

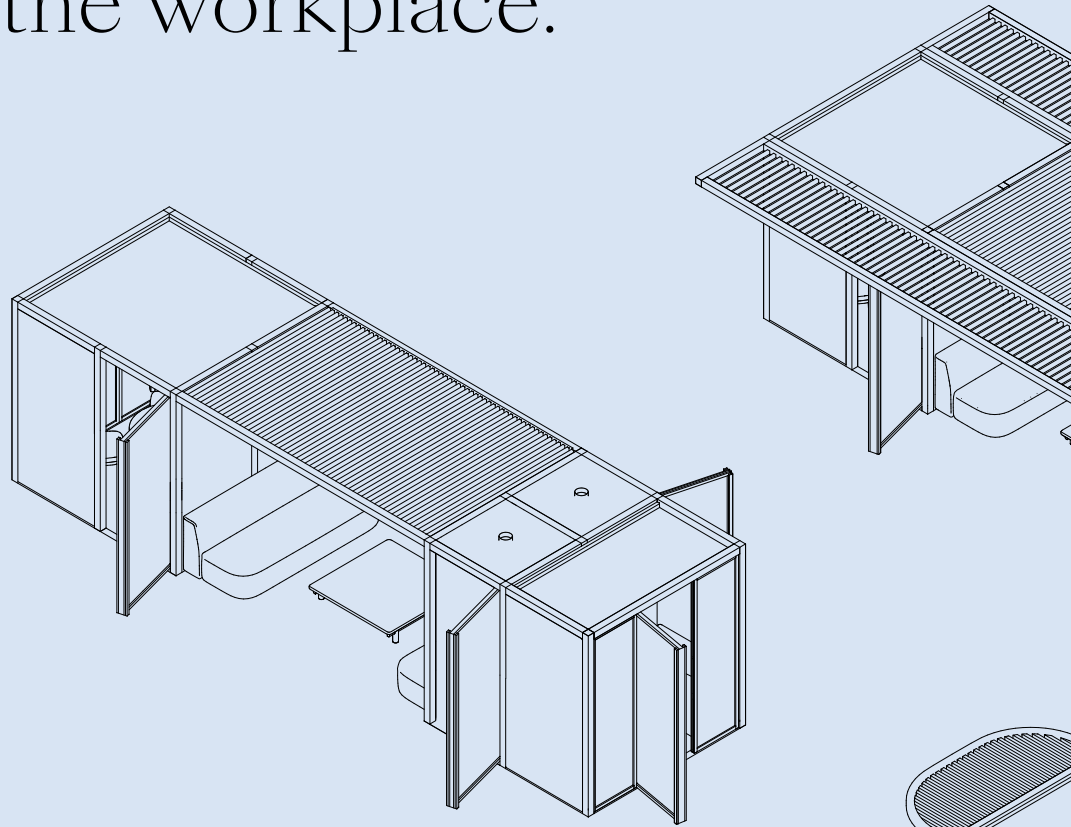

Many companies have adapted to the increasingly unpredictable market by creating agile organizational structures. To be agile, they also need office structures that can be easily reconfigured to suit ever-changing requirements. Pavilion O is the ideal structure solution for these new work environments.

The principal function of our Pavilion O is to provide a flexible way of dividing offices into zones while offering enclosed workspaces. It consists of an aluminum structure that can be built out with a variety of materials: glass, wood and fabric, as well as practical fittings: shelving, TV unit, whiteboards and bulletin boards. Our Pavilion O also allows for the integration of electrical cables and functional accessories that can be tailored to your company's specific needs.

Pavilion O facilitates the creation of countless office and workspace layouts that can be rapidly adapted to accommodate changes to your headcount or department functions. Thanks to its modular nature, the Pavilion O system gives you the power to respond quickly to the constantly changing modern world of work.

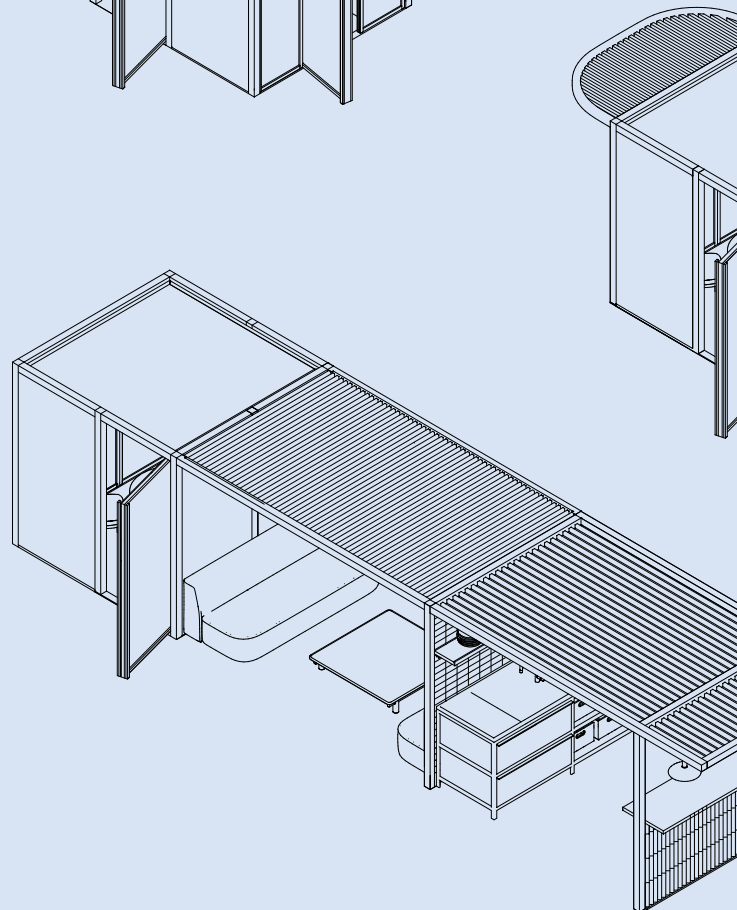



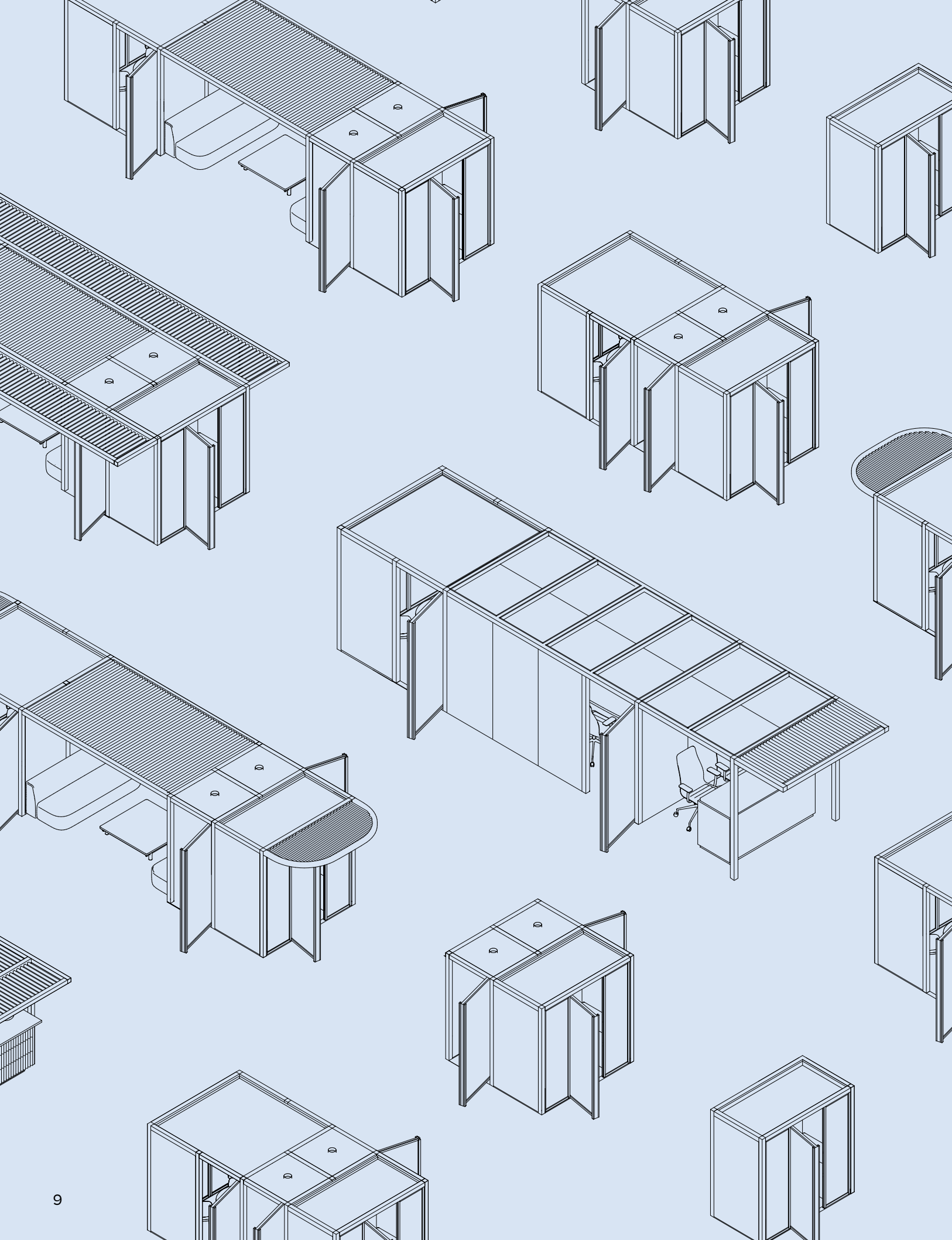

Workplace

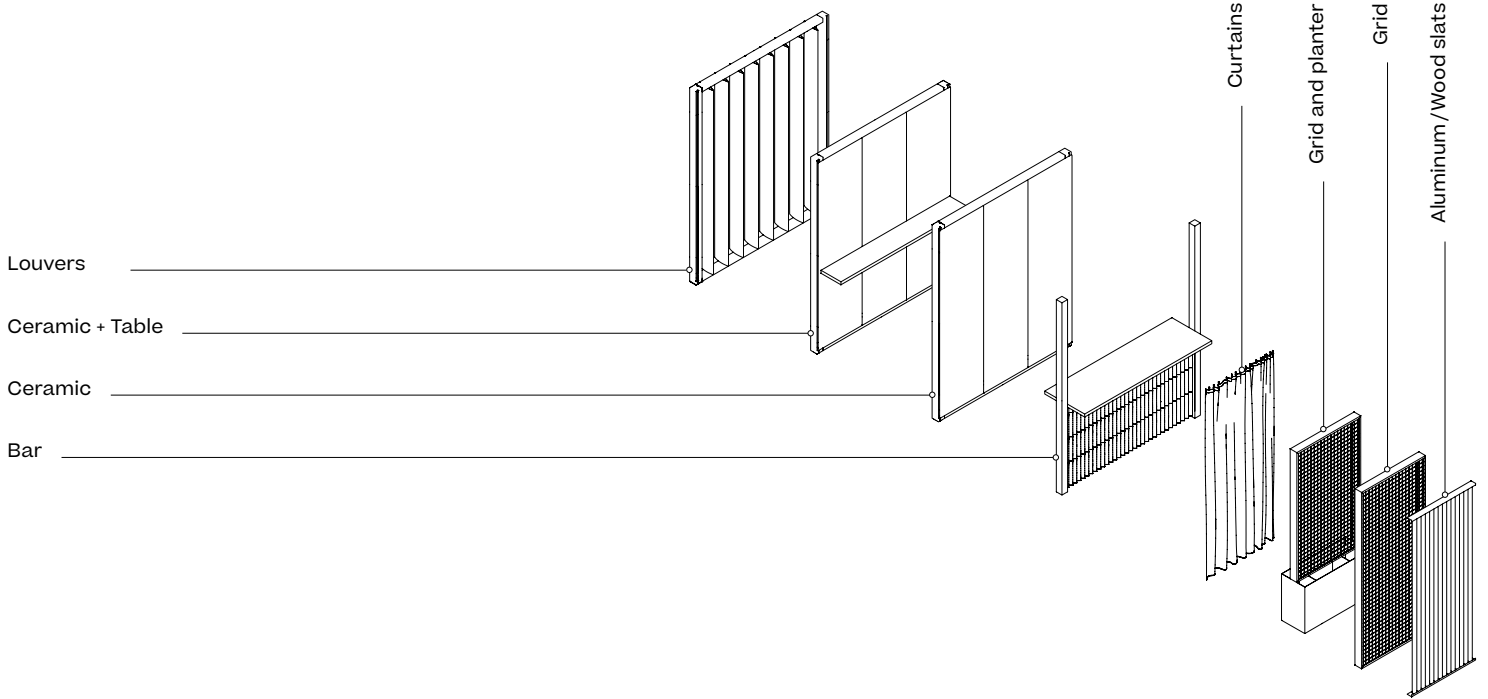

Structure

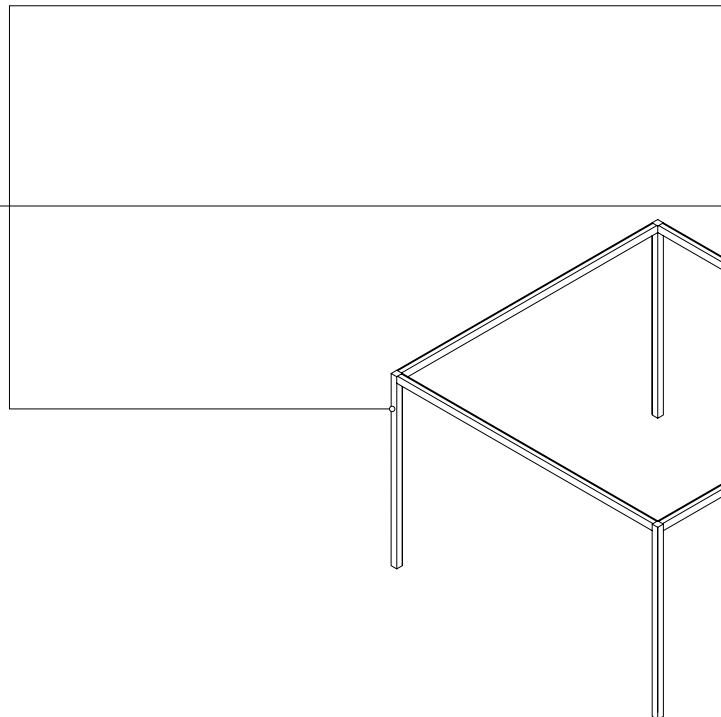

# Pavilion O

# Pavilion O

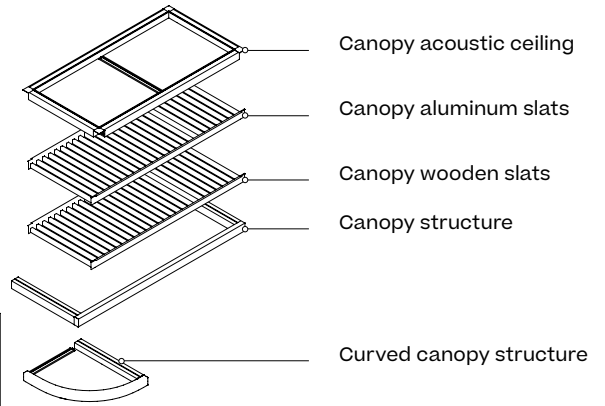
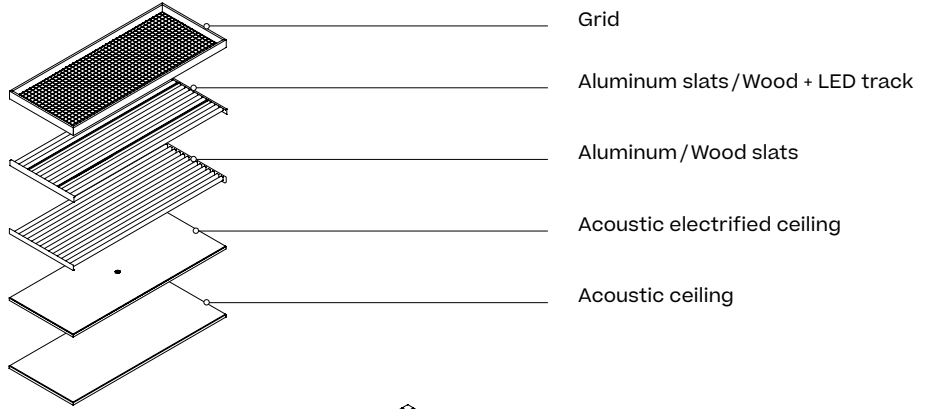
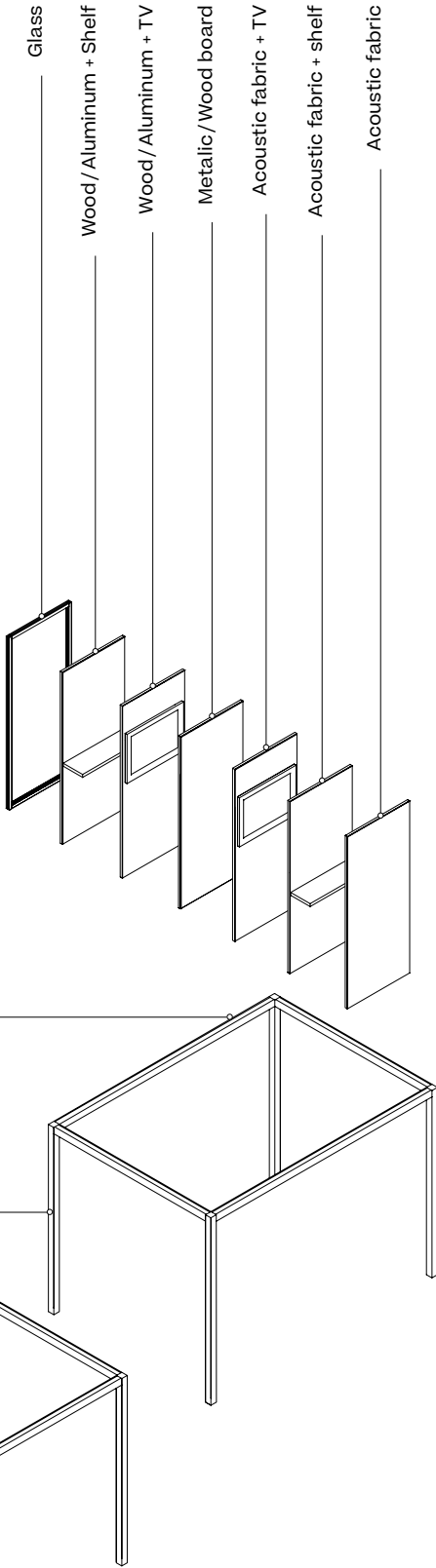

Side panels

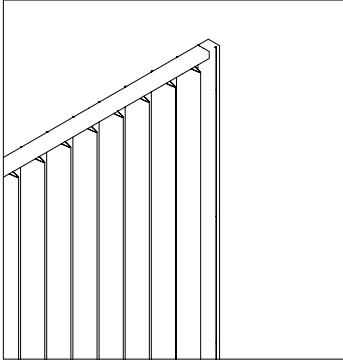

Louvers

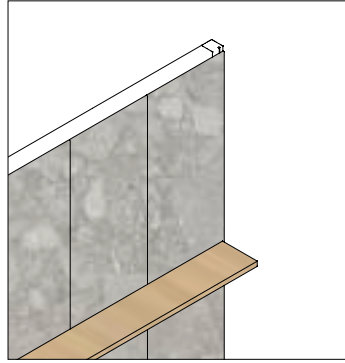

Ceramic with table

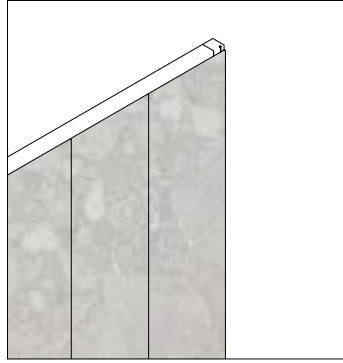

Ceramic

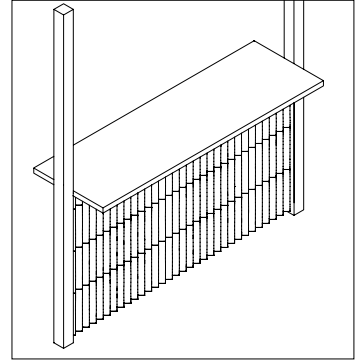

Bar

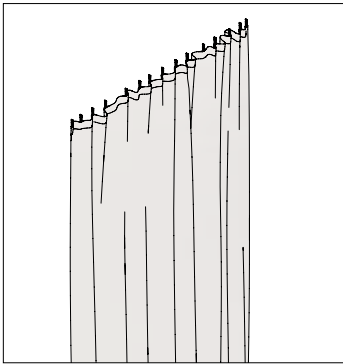

Curtains

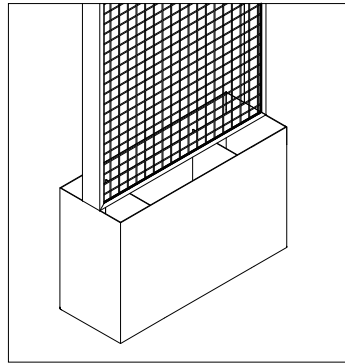

Grid with planter

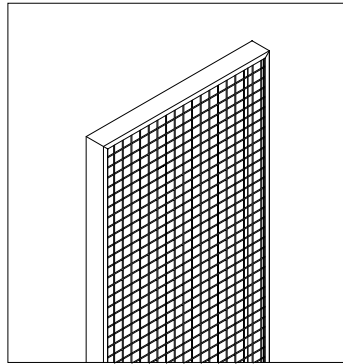

Grid

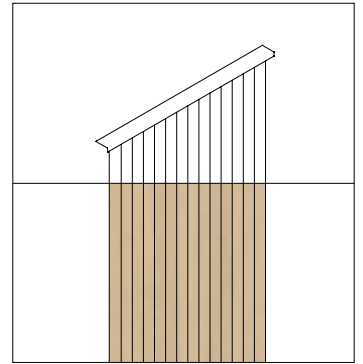

Aluminum / Wooden slats

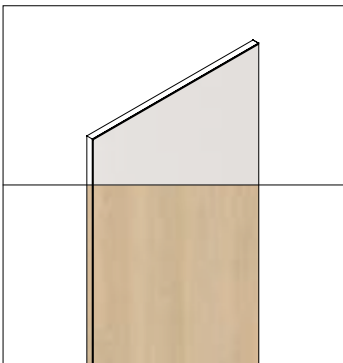

Acoustic fabric / Wood

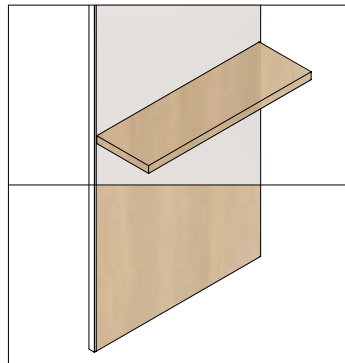

Acoustic fabric / Wood with shelf

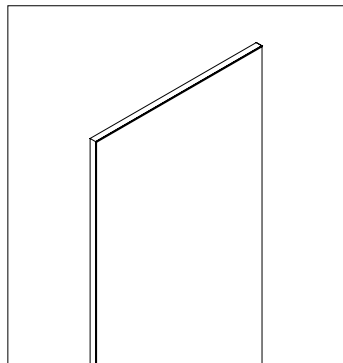

Metallic board

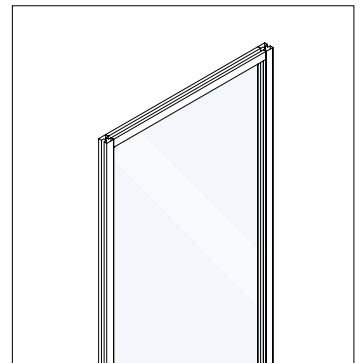

Glass

Side accessories

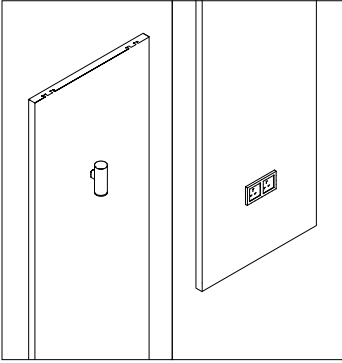

Light and plug

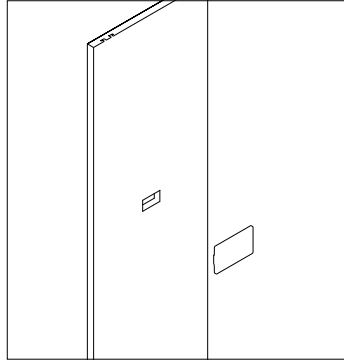

Small display

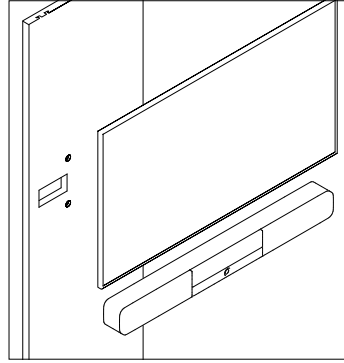

TV

Ceiling

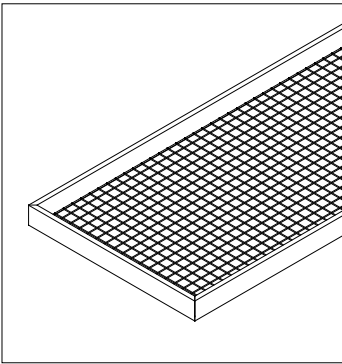

Grid

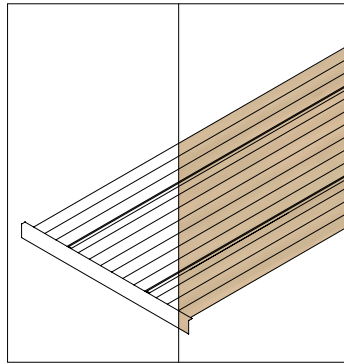

Aluminum or wooden slats with LED track

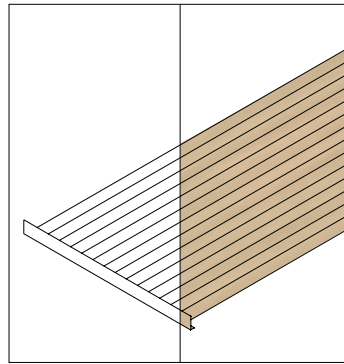

Aluminum / Wooden slats

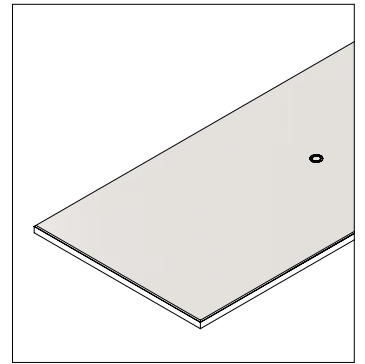

Acoustic electrified ceiling / Acoustic ceiling

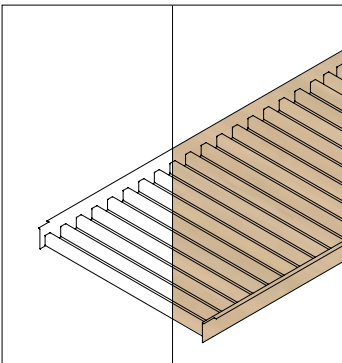

Canopy aluminum slats / Wooden slats

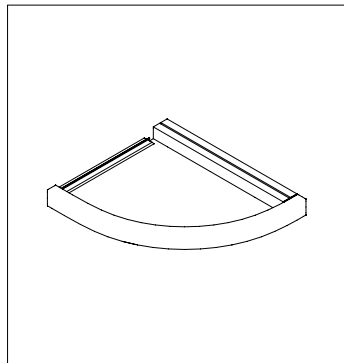

Curved canopy structure



Find out more

# Officespace

The need for flexible, open-plan workspaces is clear. Pavilion O allows you to define your own layouts in a way that meets both the demands of modern employees and the unique needs of your company. As if you were the architect of your own city, you can use Pavilion O to help you define your workplace's structure, private and public spaces, and overall flow.

---

A workplace resembling a living city,  
with its interconnected neighborhoods,  
networks and spaces.

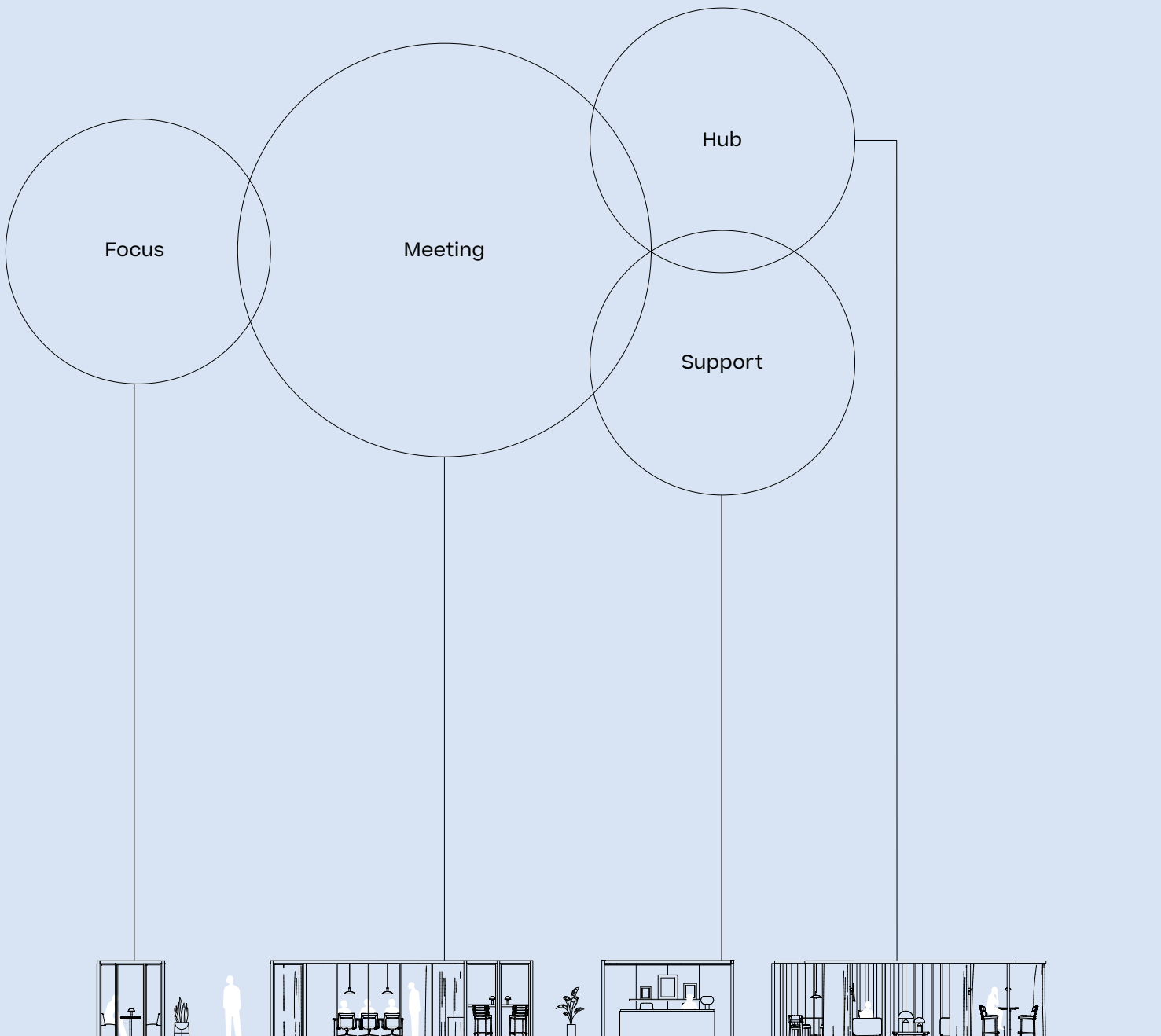





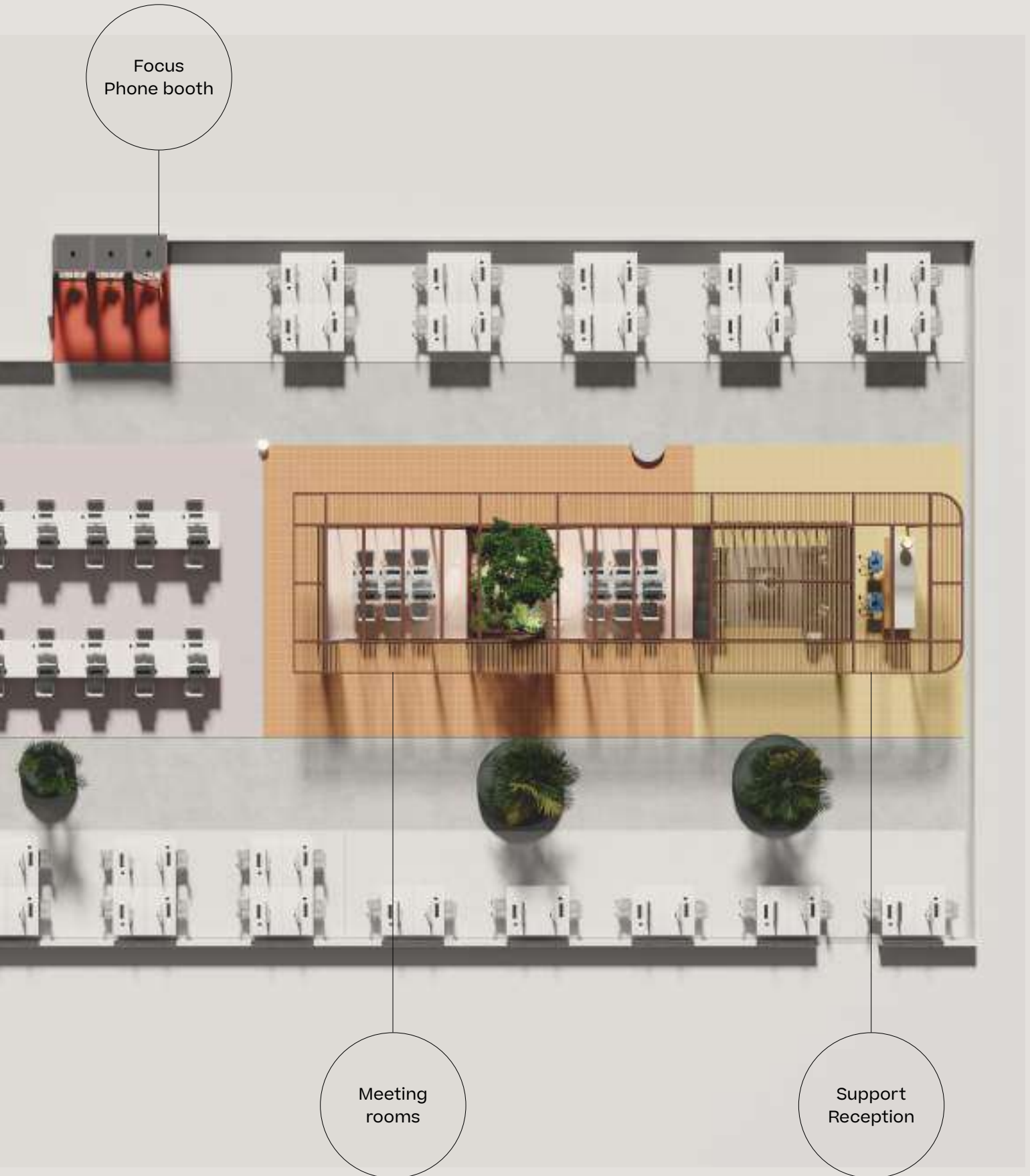

# Modularity

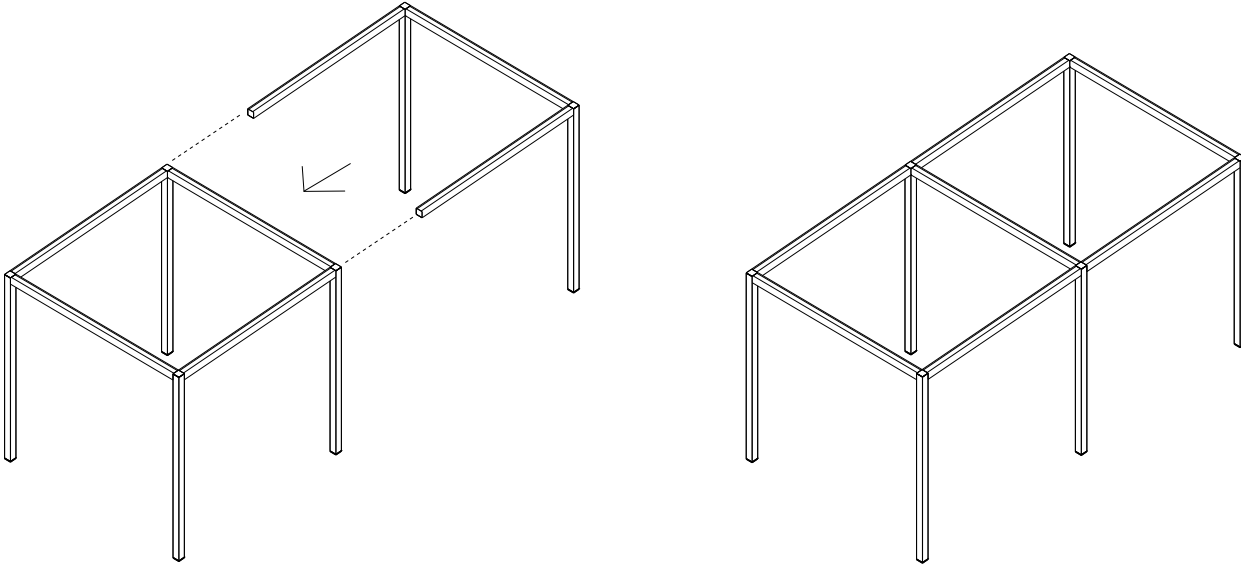

Pavilion O adapts to the context of any modern workspace. It is a dynamic way to transform your office space, thereby increasing productivity and creativity amongst your teams. It gives you the option to create several spaces; from one-person private rooms to those that can accommodate the entire team.

Your office can be set up in a variety of different configurations. The basic structure conforms to the grid layout commonly used in office planning and it has ceiling heights that can adapt to all environments.

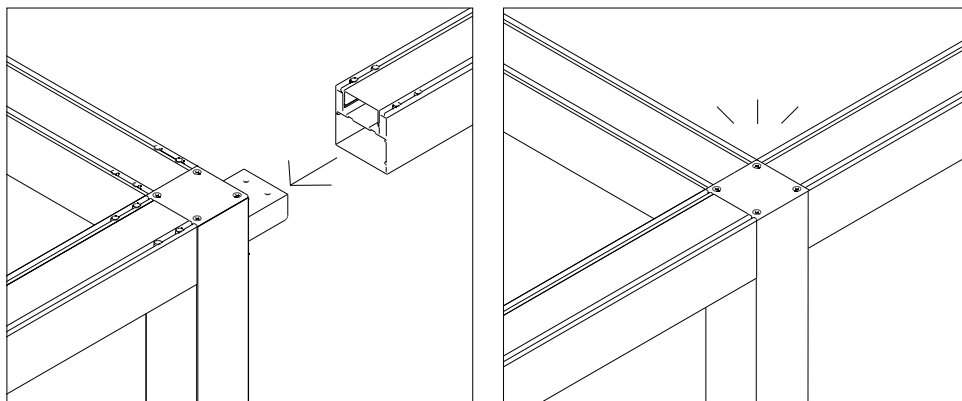

The ingenious square tube and corner connector system generates a sense of light and space.



Find out more

# Click & Work

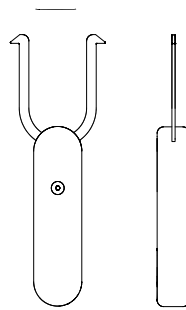
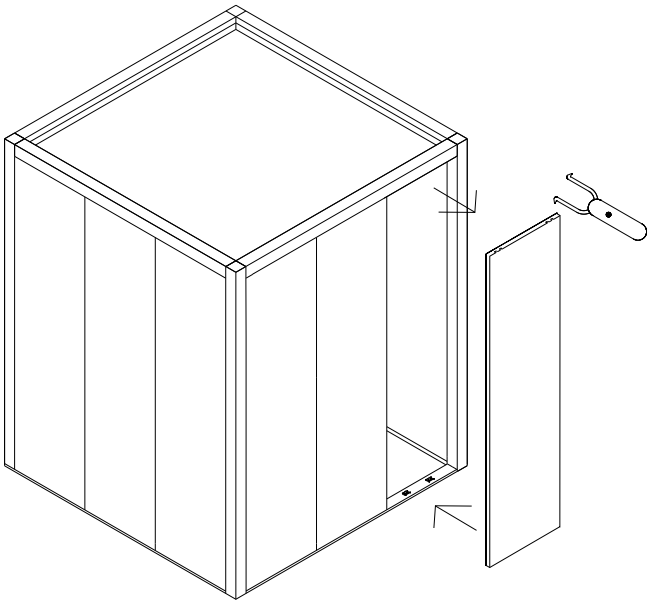

Tool needed to extract the panel

Our unique clipping system means you can transform your spaces to create your own mood ecosystems. Wall to wall or corner to corner, the scope for creating adaptable office spaces is limitless.

Configurations can be altered in a few hours to provide new spaces. A quick and easy installation demountable structure.

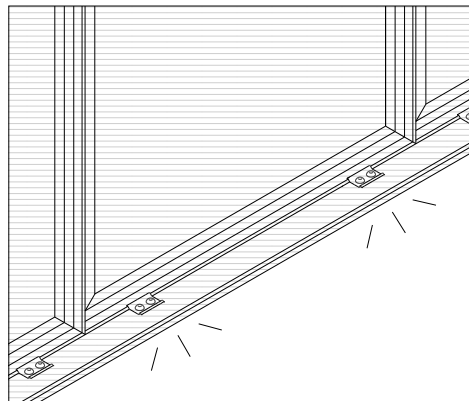
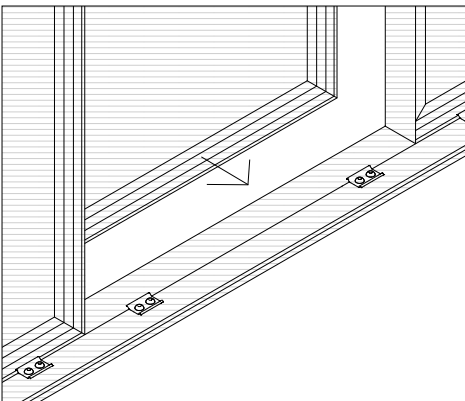

Find out more

# Focus

# Meeting

## High focus / Workpoints

---

Phone Booth S  
(1 person)  
Page 32



Phone Booth L  
(2 persons)  
Page 38

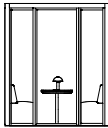

Phone Booth XL  
(4 persons)  
Page 42

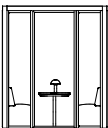

## Formal collaboration

---

Meeting rooms  
2 persons  
Page 48

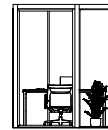

Meeting rooms  
2/4 persons  
Page 50

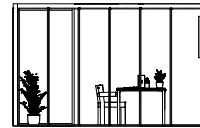

Meeting rooms  
4/6 persons  
Page 54

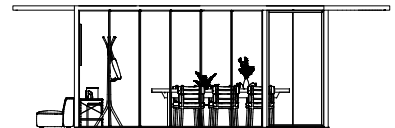

Meeting rooms  
6/8 persons  
Page 58

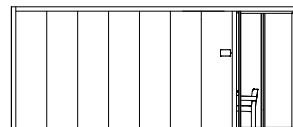

Meeting rooms  
Special size  
Page 64

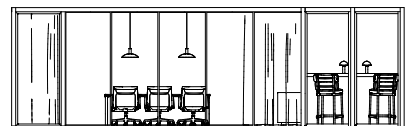

# Hub

# Support

## Flexible/Informal/Collaborative

---

Hub  
Curved  
Page 72

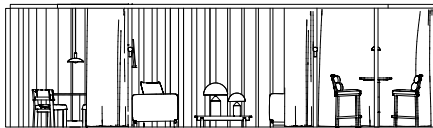

Hub  
Walk-Through  
Page 78

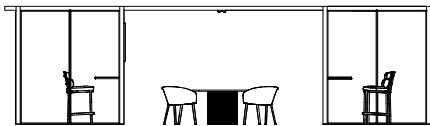

Hub Open  
With meeting  
& Sofas  
Page 82

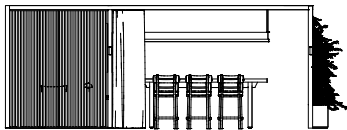

Hub Open  
With Curtains  
Page 86

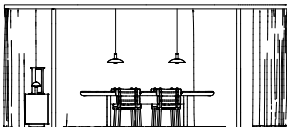

Hub Open  
Page 90

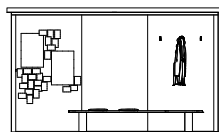

Hub  
Outdoor  
Page 104

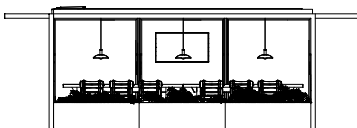

## Business/People support

---

Reception  
Page 100



Reception  
With Meeting  
& Printing Area  
Page 104

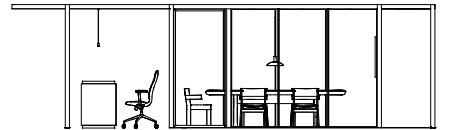

Lockers  
Page 110

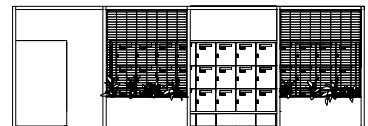

Kitchen  
Page 114

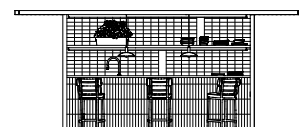

# Focus

Certain situations require your employees to increase their focus. It might be a meeting between them and a top client or it could be a puzzling problem that requires quiet analysis. Our system can help you create spaces that allow them to excel in such situations.

Spaces tailored for those occasions when isolated work is required.

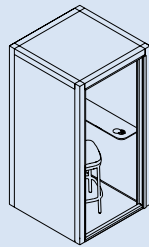

Phone Booth S

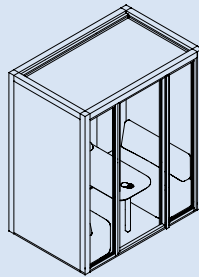

Phone Booth L

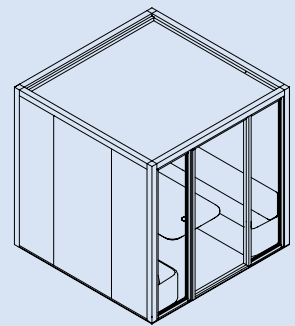

Phone Booth XL

# Phone Booth



Privacy can be hard to come by in large open offices. Our Phone booth O allows your employees to make calls or hold video conferences with unbroken focus and without disturbing the rest of the team. The Phone booth O design is inspired by the traditional telephone booth. They are an elegant yet functional solution for your office. Comfortable and echo-free, the Phone booth O is also simple to install.





# Phone booths

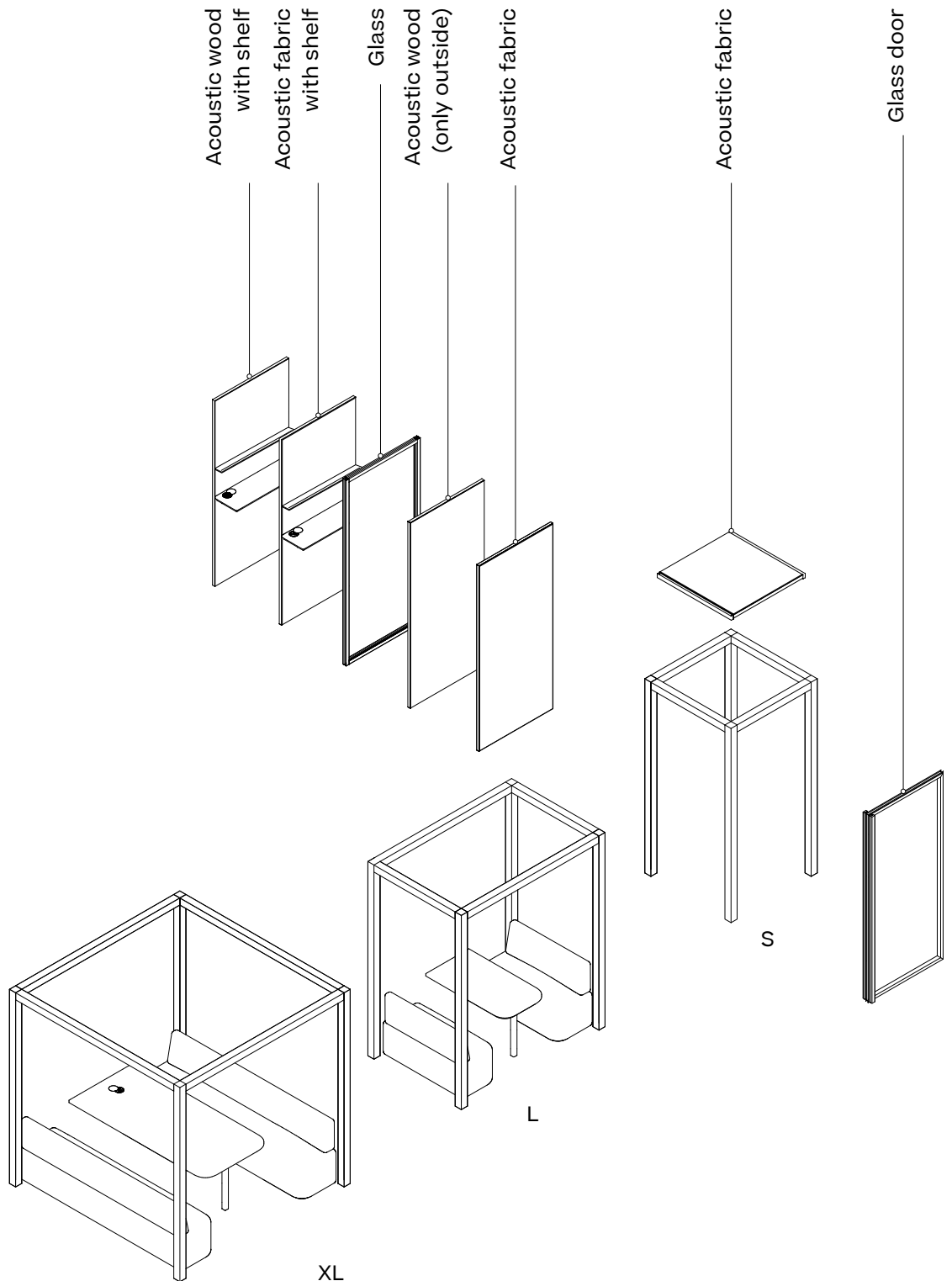

## Focus

## Features



Table with Plug / USB- A / USB-C



Shelf + Led light + PIR



LED track curtain



Handicap flooring, pivoting door



Plug and play

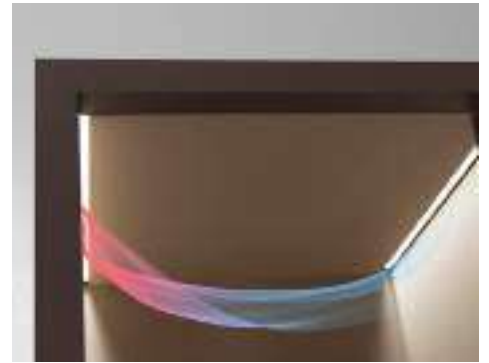

Ventilation system



Crestron screen (optional)

# Phonebooth S

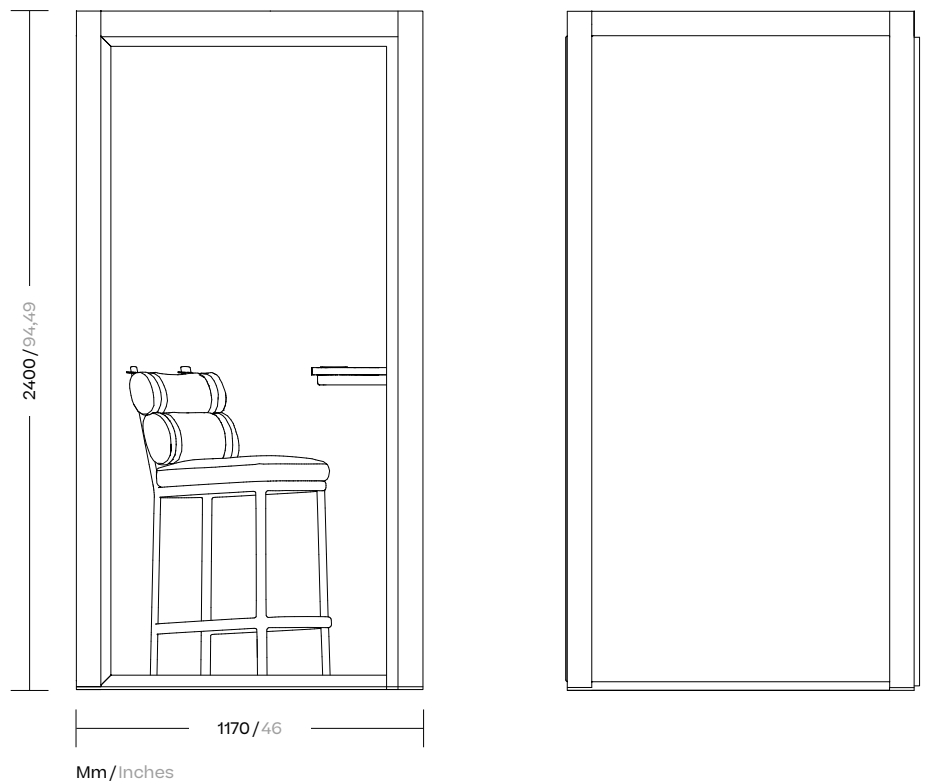

## Description

A Phonebooth with one seat. Ideal to join a call or video conference with your client, free from all distractions. The exceptional acoustics and physical comfort allow for better communication, as well as concentration.

## Specifications

- Single or double glazed wall system
- Fabric or glass
- Pivot door
- Faced external wall
- Metal frame
- Air ventilation system
- Acoustic panels
- LED lighting
- Absorption system
- PIR sensor





Focus

Version A



3 fabric sides

Version B



2 fabric sides & 1 glass side







# Phonebooth L

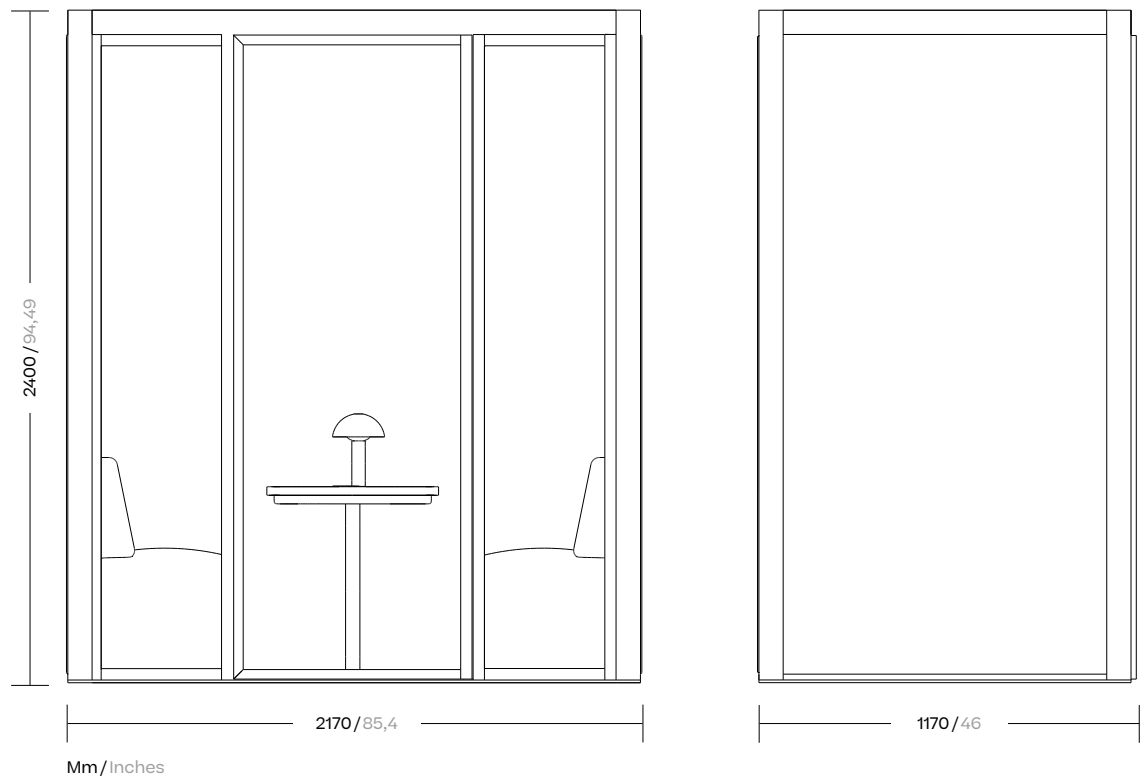

## Description

A Phonebooth with 2 seats. Convenient to sit down for one-on-one meetings in private. The exceptional acoustics and physical comfort allow for better communication, as well as concentration.

## Specifications

- Single or double glazed wall system
- Pivot door
- Metal frame
- Acoustic panels
- Absorption system
- Fabric or glass
- Faced external wall
- Air ventilation system
- LED lighting
- PIR sensor







# Phone booth XL

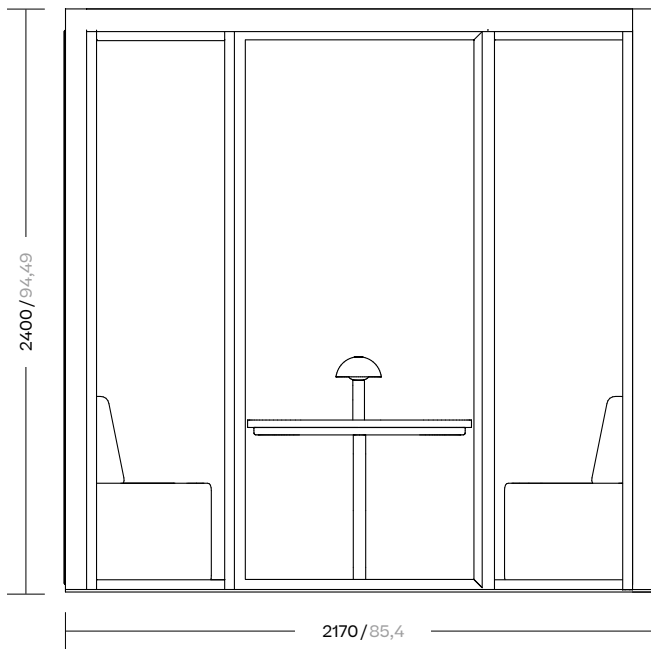

Mm/Inches

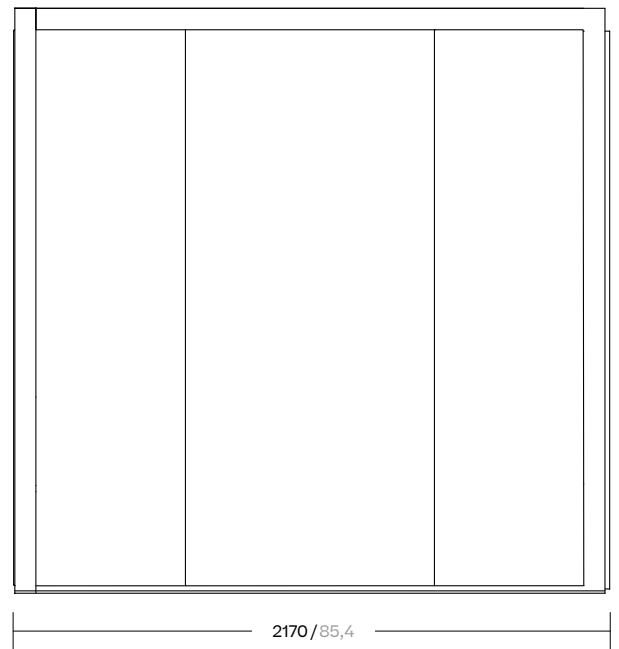

## Description

A Phone Booth with 4 seats. Ideal for meetings in spacious comfort and privacy. The exceptional acoustics and physical comfort allow for better communication, as well as concentration.

## Specifications

- Single or double glazed wall system
- Fabric or glass
- Pivot door
- Faced external wall
- Metal frame
- Air ventilation system
- Acoustic panels
- LED lighting
- Absorption system
- PIR sensor









# Meeting

Whether it is a meeting with colleagues or clients, you want to optimize its effectiveness. Comfort is crucial — particularly when your meeting is long in duration. We recognize this and have designed accordingly. Our superior sound insulation provides a quiet, distraction-free environment for holding your meetings without disturbing those in the vicinity.

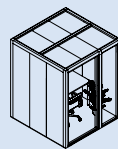

Meeting Room  
2 persons

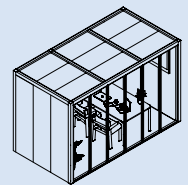

Meeting Room  
2/4 persons

Comfort and silence means  
better communication and  
better meetings.

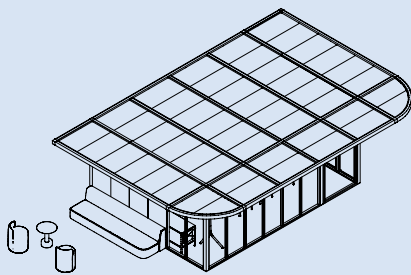

Meeting Room  
4/6 persons

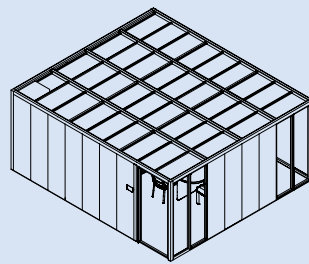

Meeting Room  
6/8 persons

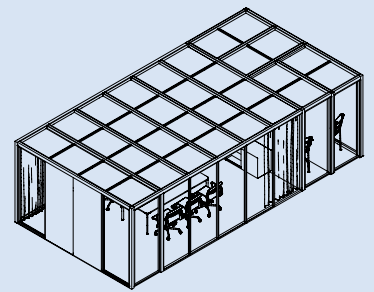

Meeting room  
Special sizes

# Meeting room 2 persons



## Description

A meeting room fitting 2 persons. You can sit down alone for a meeting with your clients or colleagues who are participating remotely. The exceptional acoustics and physical comfort allow for better communication, as well as concentration.

The adaptable system allows for the integration of additional open modules with different functions.

## Specifications

- Single or double glazed wall system
- Pivot door
- Metal frame
- Acoustic panels
- Absorption system
- Fabric / Metal / Wood / Glass
- Faced external wall
- Air ventilation system
- LED lighting
- PIR sensor
- Adaptable and modular
- AV systems option
- Dimmable lights



# Meeting room 2/4 persons

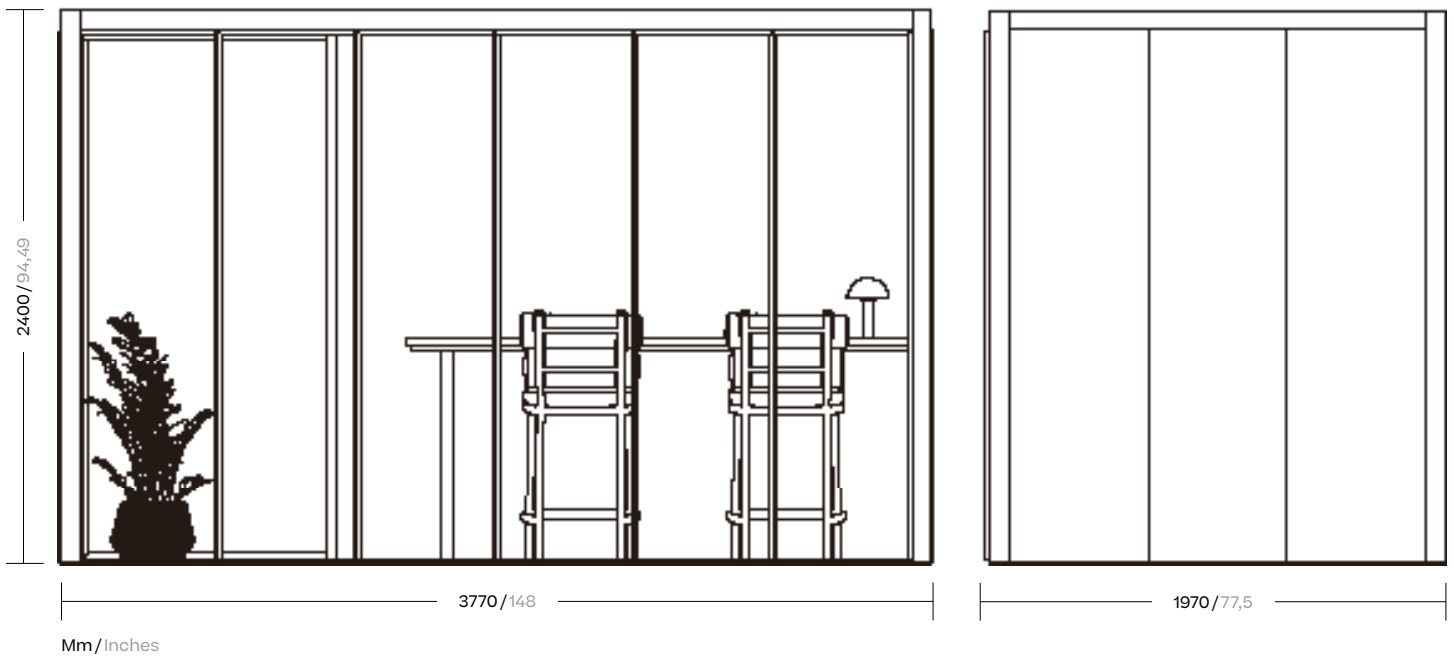

## Description

Gather with a group of up to four to conduct a meeting. The exceptional acoustics and physical comfort allow for better communication, as well as concentration.

The adaptable system allows for the integration of additional open modules with different functions.

## Specifications

- Single or double glazed wall system
- Pivot door
- Metal frame
- Acoustic panels
- Absorption system
- Fabric / Metal / Wood / Glass
- Faced external wall
- Air ventilation system
- LED lighting
- PIR sensor
- Adaptable and modular
- Dimmable lights
- AV systems option









# Meeting room 4/6 persons

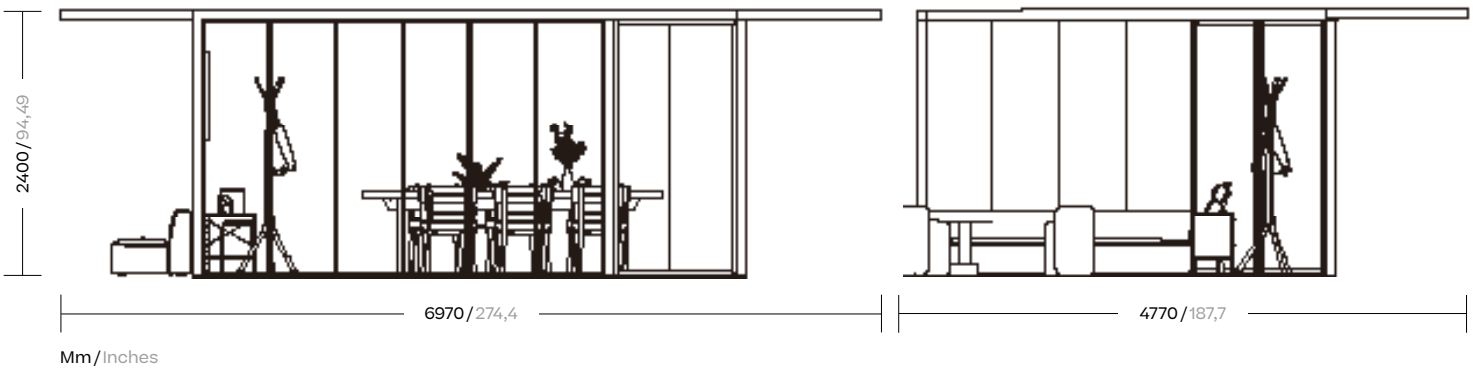

## Description

A meeting room that can accommodate up to 6 persons. The exceptional acoustics and physical comfort allow for better communication, as well as concentration.

The adaptable system allows for the integration of additional open modules with different functions.

## Specifications

- Single or double glazed wall system
- Pivot door
- Metal frame
- Acoustic panels
- Absorption system
- Fabric/Metal/Wood/Glass
- Faced external wall
- Air ventilation system
- LED lighting
- PIR sensor
- Adaptable and modular
- Dimmable lights
- AV systems option







# Meeting room 6/8 persons



## Description

A meeting room for up to 8 persons. The exceptional acoustics and physical comfort allow for better communication, as well as concentration.

The adaptable system allows for the integration of additional open modules with different functions.

## Specifications

- Single or double glazed wall system
- Pivot door
- Metal frame
- Acoustic panels
- Absorption system
- Fabric / Metal / Wood / Glass
- Faced external wall
- Air ventilation system
- LED lighting
- PIR sensor
- Adaptable and modular
- Dimmable lights
- AV systems option













# Meeting room Special size

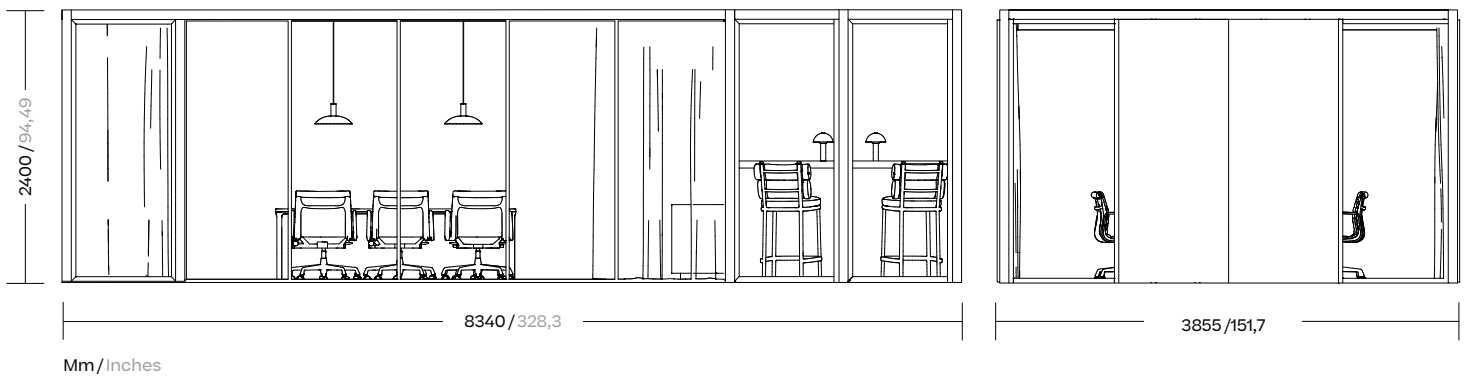

## Description

A meeting room accommodating up to 10 persons. The exceptional acoustics and physical comfort allow for better communication, as well as concentration.

The adaptable system allows for the integration of additional open modules with different functions.

## Specifications

- Single or double glazed wall system
- Pivot door
- Metal frame
- Acoustic panels
- Absorption system
- Fabric / Metal / Wood / Glass
- Faced external wall
- Air ventilation system
- LED lighting
- PIR sensor
- Adaptable and modular
- Dimmable lights
- AV systems option













# Hub

Hub offers you a third-space within your actual office space. Your employees can mingle for chats, impromptu brainstorming sessions or perhaps a quick coffee after an intense meeting with a top client. The flexibility of our Hub system enables you to create scenes that complement whatever vision you have for your office culture.

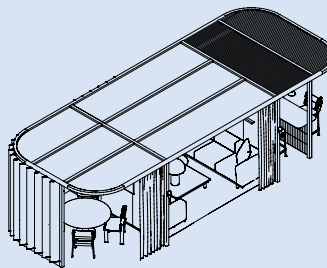

Hub Curved

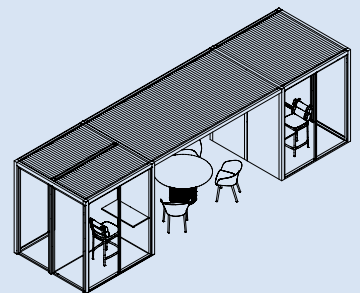

Hub Walk Through

# Hybrid structures to connect your staff in a social way.

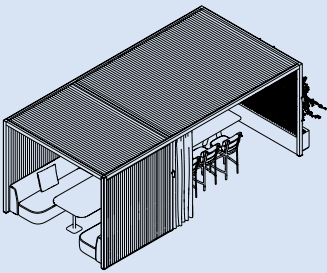

Hub Open  
With Meeting & Sofas

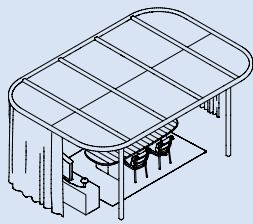

Hub Open  
With Curtains

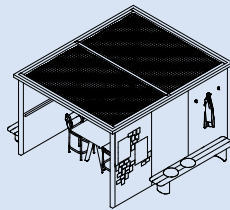

Hub Open

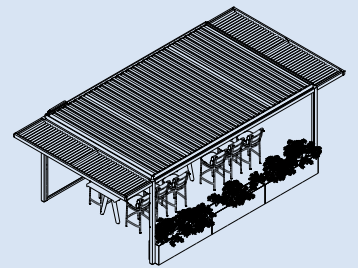

Hub Outdoor

# Hub Curved

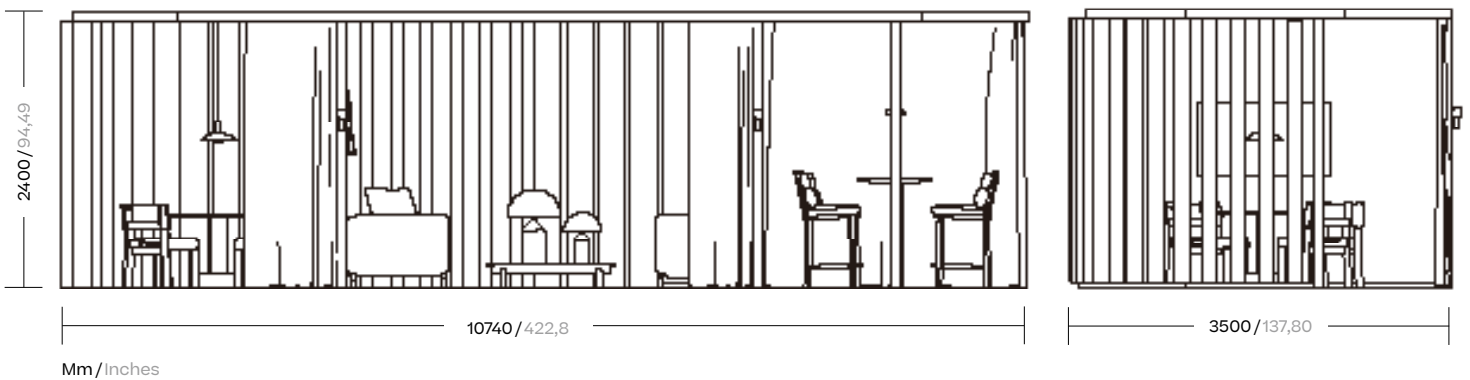

## Description

Three zones under one roof. Whether it is for sitting, meeting or taking a break, this curved structure will suit a variety of casual or impromptu interactions.

## Specifications

- Single or double glazed wall system
- Pivot door
- Metal frame
- Acoustic panels
- Absorption system
- Fabric / Metal / Wood / Ceramic / Glass
- Faced external wall
- Air ventilation system
- LED lighting
- PIR sensor
- Adaptable and modular
- Dimmable lights
- AV systems option







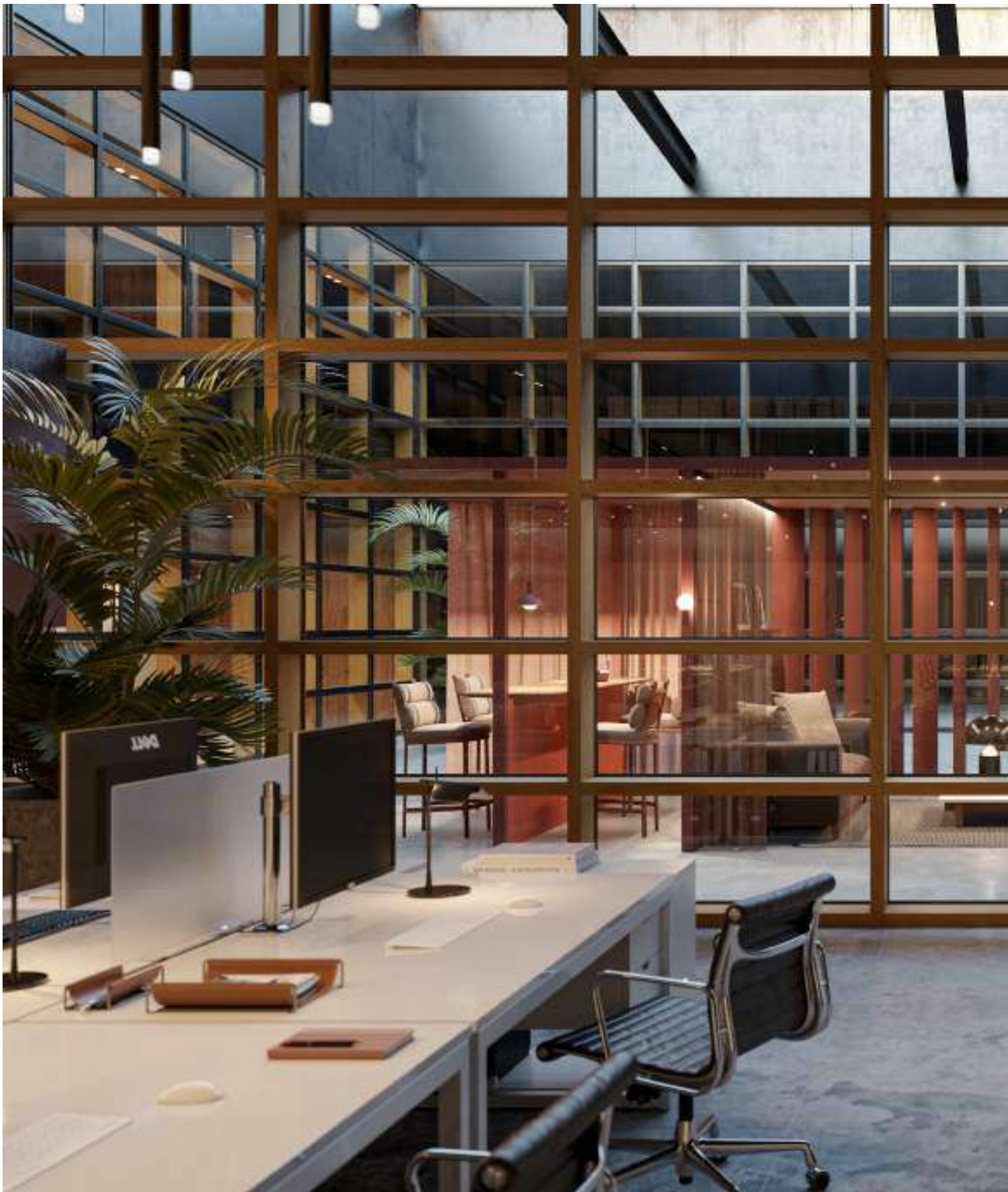





# Hub Walk Through

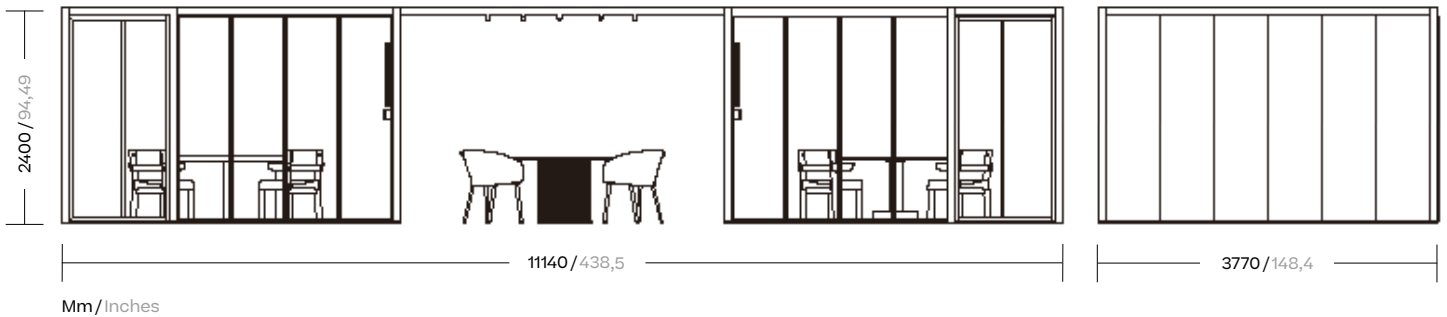

## Description

Two spacious meeting rooms either side of a more casual open gathering point. Suitable for either formal or relaxed interactions.

## Specifications

- Single or double glazed wall system
- Pivot door
- Metal frame
- Acoustic panels
- Absorption system
- Fabric / Metal / Wood / Ceramic / Glass
- Faced external wall
- Air ventilation system
- LED lighting
- PIR sensor
- Adaptable and modular
- Dimmable lights
- AV systems option







# Hub Open With meeting & Sofas

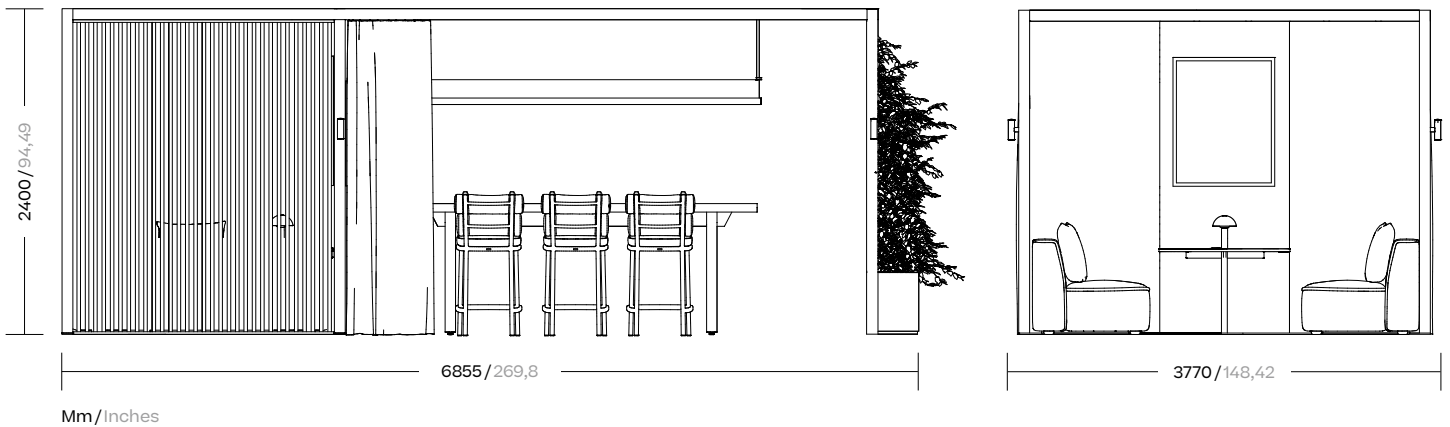

## Description

A six-person, high-table discussion space attached to a sofa area. Suitable for a variety of semi private gatherings.

## Specifications

- Single or double glazed wall system
- Pivot door
- Metal frame
- Acoustic panels
- Absorption system
- Fabric / Metal / Wood / Ceramic / Glass
- Faced external wall
- Air ventilation system
- LED lighting
- PIR sensor
- Adaptable and modular
- Dimmable lights
- AV systems option









# Hub Open With Curtains

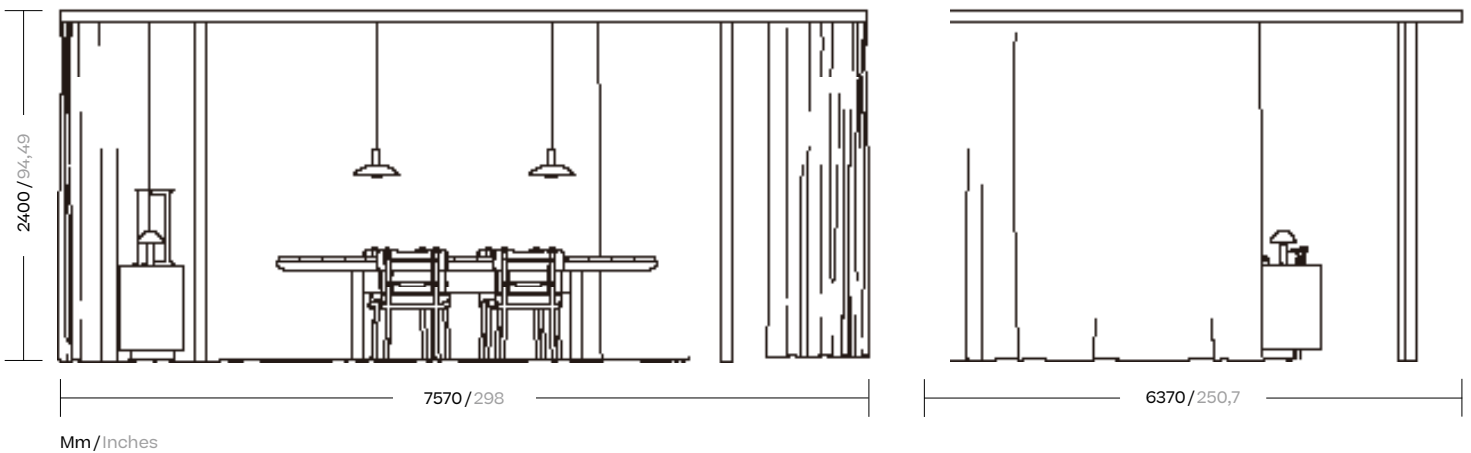

## Description

An open meeting space with curtains that add an atmospheric, living room-like comfort. Suitable for a small group to meet in a relaxed fashion.

## Specifications

- Single or double glazed wall system
- Pivot door
- Metal frame
- Acoustic panels
- Absorption system
- Fabric / Metal / Wood / Ceramic / Glass
- Faced external wall
- Air ventilation system
- LED lighting
- PIR sensor
- Adaptable and modular
- Dimmable lights
- AV systems option







# Hub Open

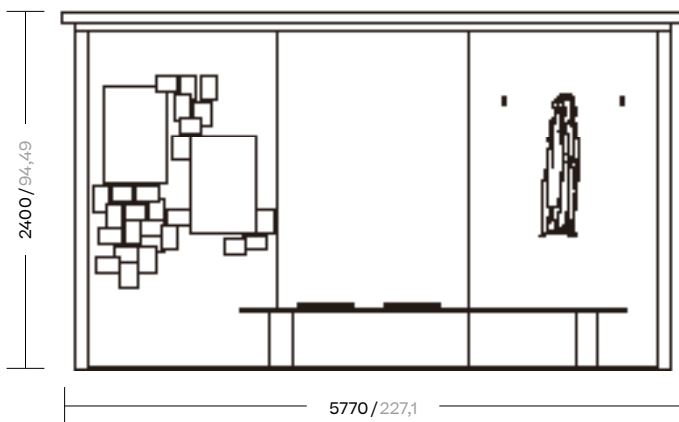

Mm/Inches

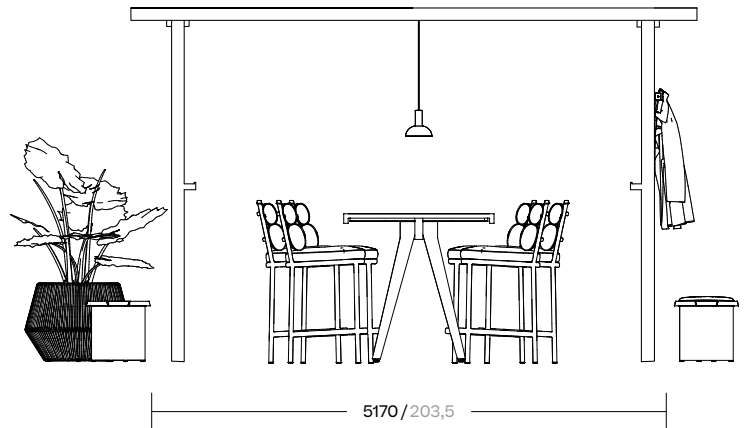

## Description

An open and creative space. Ideal for brainstorming on the go. Includes a small bench at the rear.

## Specifications

- Single or double glazed wall system
- Pivot door
- Metal frame
- Acoustic panels
- Absorption system
- Fabric / Metal / Wood / Ceramic / Glass
- Faced external wall
- Air ventilation system
- LED lighting
- PIR sensor
- Adaptable and modular
- Dimmable lights
- AV systems option









# Hub Outdoor

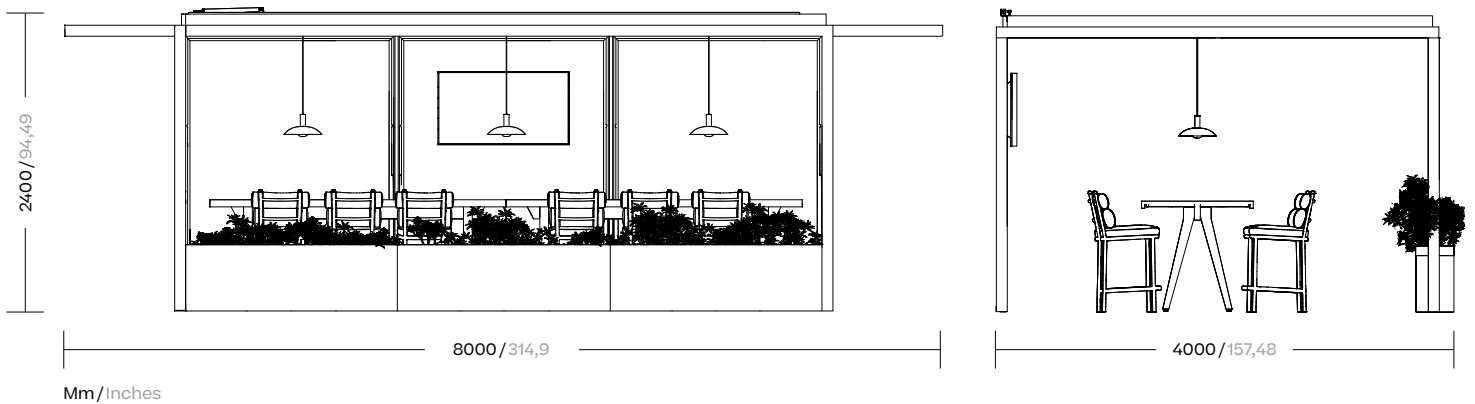

## Description

We designed the pavilion from the perspective of adaptability and it is therefore extremely versatile. It can be integrated not only with indoor spaces but also with outdoor ones too. Its flexible and modular structures enable it to be used as a large shade and even for the creation of covered walkways.

## Specifications

- Pavilion H profile
- Aluminium frame
- Accesories
- Fabric, glass, wood, stone
- LED lighting
- PIR sensor







# Support

From receptions and printing areas to kitchens and lockers, there are additional areas that every modern office is expected to have. We have designed structures that can provide for all of these support areas in a most stylish way.

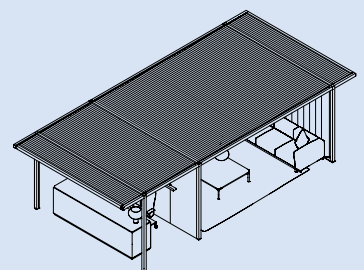

Reception & Lounge

# Functional spaces that support the smooth running of your business.

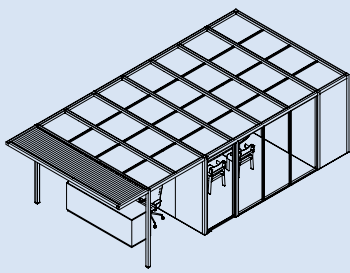

Reception With Meeting & Printing Area

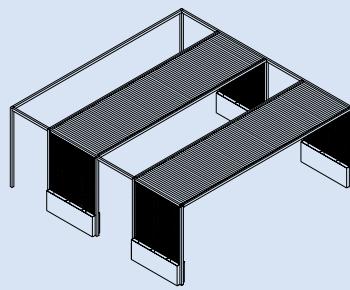

Lockers

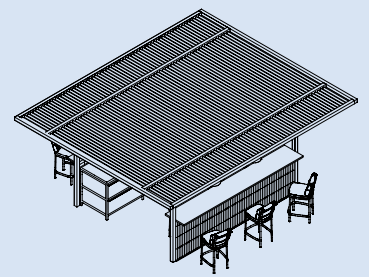

Kitchen

# Reception

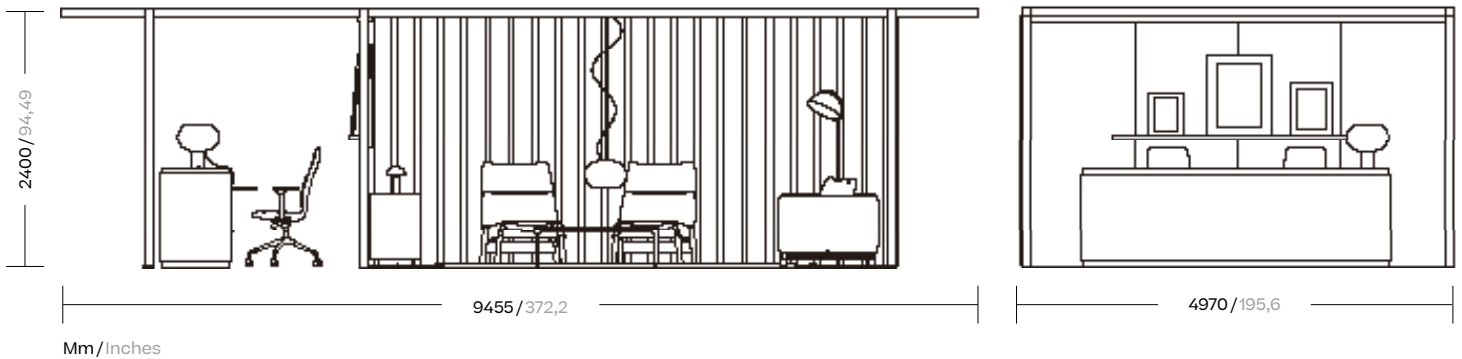

## Description

A sleek reception and waiting area that also impresses visiting clients.

## Specifications

- Single or double glazed wall system
- Pivot door
- Metal frame
- Acoustic panels
- Absorption system
- Fabric or glass
- Faced external wall
- Air ventilation system
- LED lighting
- PIR sensor









# Reception With Meeting & Printing Area

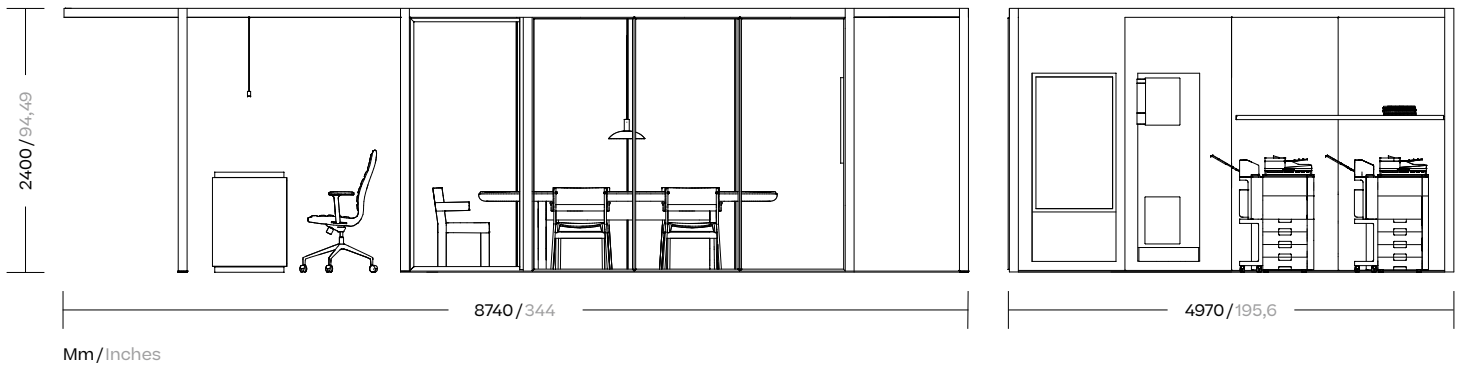

## Description

A dedicated printing area that neighbors a smart reception and spacious meeting room to support your business operations.

## Specifications

- Single or double glazed wall system
- Pivot door
- Metal frame
- Acoustic panels
- Absorption system
- Fabric or glass
- Faced external wall
- Air ventilation system
- LED lighting
- PIR sensor













# Lockers

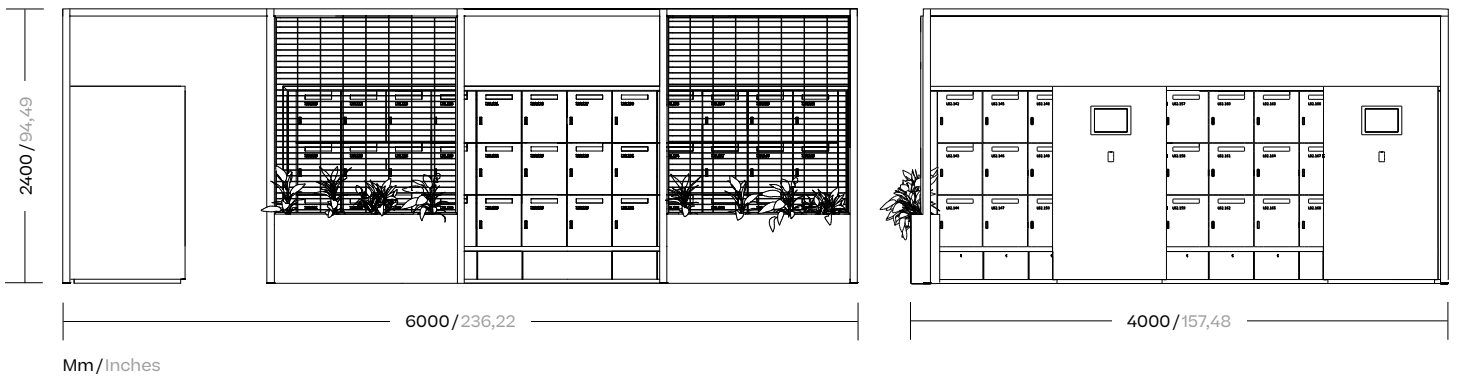

## Description

A convenient locker area to support your employees and their lifestyles.

## Specifications

- Single or double glazed wall system
- Pivot door
- Metal frame
- Acoustic panels
- Absorption system
- Fabric or glass
- Faced external wall
- Air ventilation system
- LED lighting
- PIR sensor







# Kitchen

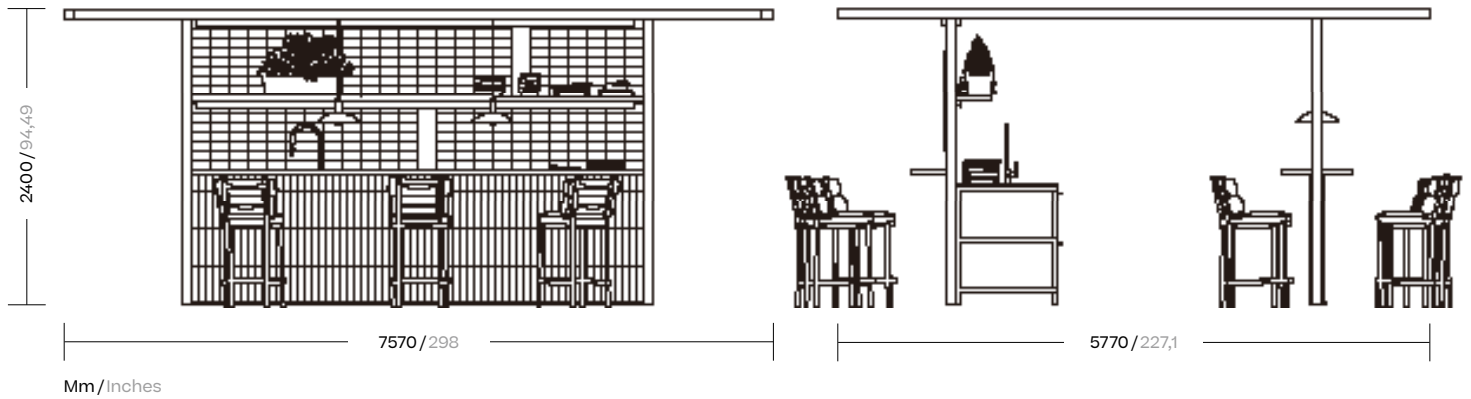

## Description

A clever and open kitchen to support your employees while they recharge and interact with each other.

## Specifications

- Single or double glazed wall system
- Pivot door
- Metal frame
- Acoustic panels
- Absorption system
- Fabric or glass
- Faced external wall
- Air ventilation system
- LED lighting
- PIR sensor









EXIT

# Technical specifications

Since the introduction of computers, office structures and work habits have never undergone such a radical transformation as the one we are currently experiencing. Thanks to communication technology, offices are becoming public spaces. Many companies create open-plan and inspiring places in which employees and visitors can relax, hold meetings or spend the day working. The daily use of laptops, smartphones and tablets has given rise to new patterns of behavior that are now also observed in offices. Home automation, audiovisual media, network connections and booking rooms are necessary resources for day-to-day work in the office.

Unlock extra workspace potential  
with cutting edge technology.

# Control managment

## Description

A QR system enables room control, and is compatible with Android, iOS mobile and tablet devices. Domotics is a smart technology. It is a fully integrated Creston business space solutions that streamline workflows and resource management for smarter, more efficient workplaces. Creston is the only platform that enable s you to perform all your daily activities (calls, presentations, collaboration) in every one of your workspaces and manage them securely online.

In addition to Creston, we at Kettal also collaborate with other technology partners such as Samsung and Jun.

## Key funtions

- Light scenes
- Climate control
- Audiovisual hardware
- Booking
- QR code

## Personal



Touch Screen



Smartphone



Tablet

## Technical specifications

### Description

Centralised software enables the integration between the room booking system and control of individual rooms. In conjunction with XiO Cloud, the system can be fully monitored, updated and managed from anywhere.

### Key functions

- Monitoring
- Remote helpdesk operations
- Proactive hardware maintenance
- Room utilization reporting

### Centralized



Monitoring



Room utilization



Reporting

# Monitor & audiovisuals

## Monitor key functions

---

- 4K camera
- 150° viewing angle
- Amplified HD Audio
- Beam forming mic
- HD Camera
- Plug & Play system

Personal or remote device controled  
WiFi or Wired connection

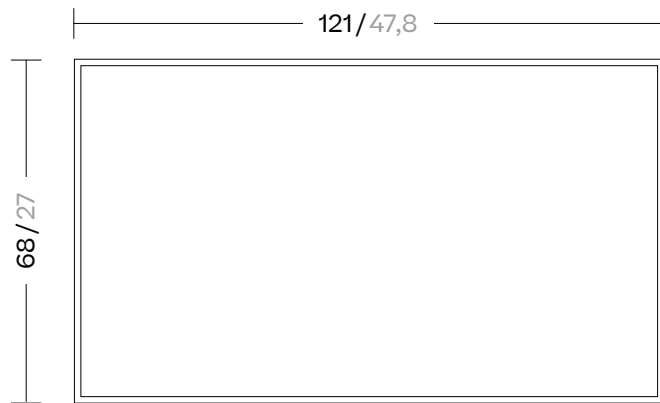

Cm/Inches

## Key Features

---

- Secure
- Can be managed remotely
- Fast connection
- Table equipped with network
- Data connection between Wireless

## Hardware

---

- Slim video monitor
- 4K camera with 150° viewing
- Surrounding audiosystem
- Full set of configurable

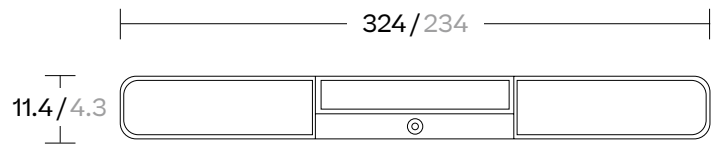

Cm/Inches

\* 3 different sizes



# Room booking

## Key functions

- Booking management through Touch Screen
- Room reservation linked to your Calendar
- Management through third-party Cloud solution



Secure endpoint



Cloud solution



Calendaring

## Directly connects to:



## Choose the application

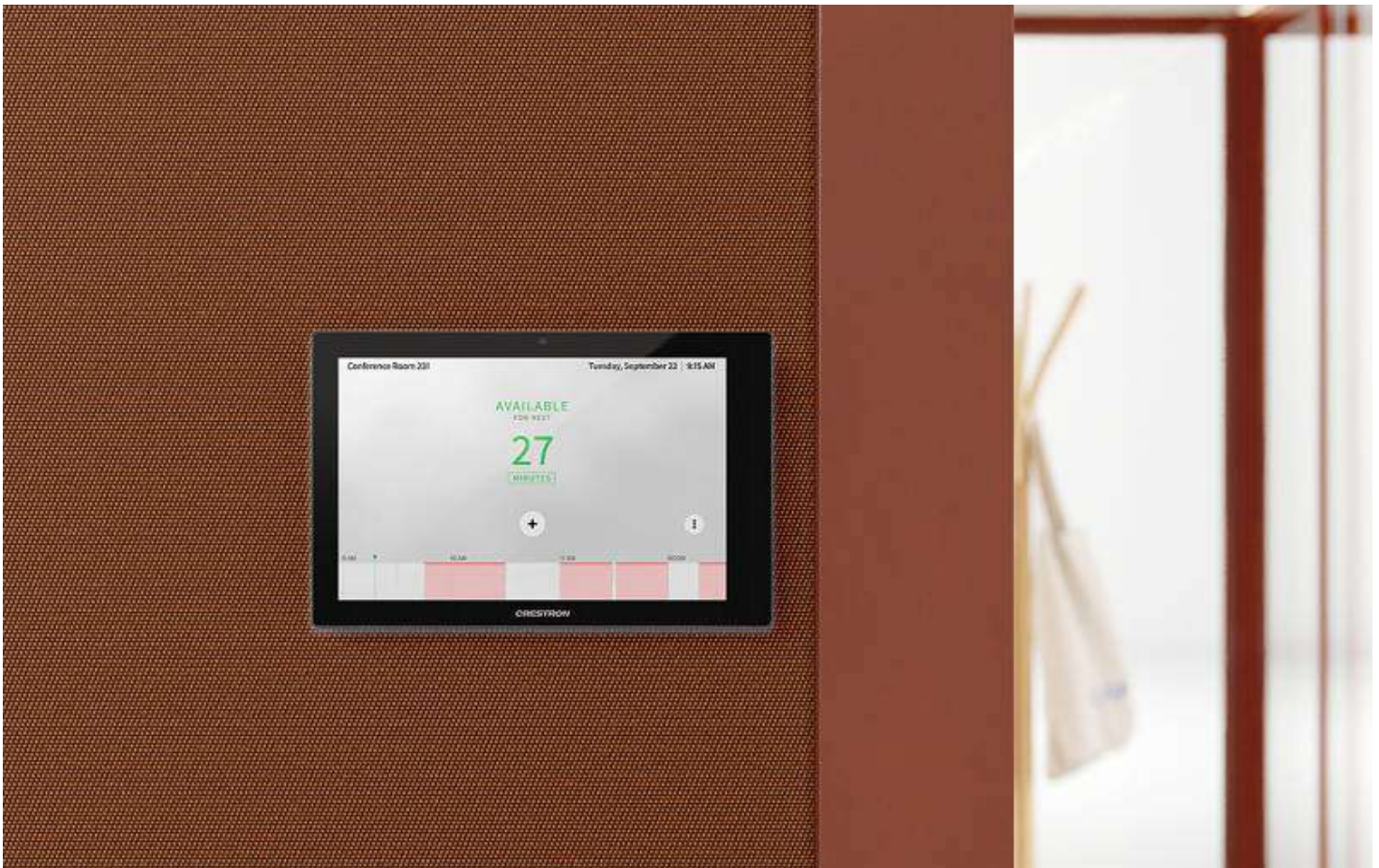



# Safety

## Key functions

---

- Smoke detection (\*)
- PAVA integrated in Soundbar
- Sprinklers (\*)
- Security devices linked to the building alarm system
- Lighting - Spotlights will function as emergency lighting



Smoke detector



Sprinklers

(\*) For technical information see  
Product Specifications section



# Air ventilation

## Key functions

- Silent air circulation system
- Intelligent monitoring through CO<sub>2</sub>, humidity and temperature sensors (optional)
- Equipment has particle filtration and microorganism elimination by germicidal ultraviolet light (optional)
- Climate building system compatibility
- Prefilter M5 (65% efficiency 0,3 micron particules)
- Absolute HEPA Filter (99,97% efficiency on 0,3 micron particules. (optional)
- CPZ filter for gas and odor removal (activated Carbon, Potassium Permanganate and Zeolite, efficiency greater than 90%) (optional)

## Sensor for CO<sub>2</sub> & humidity

## Air extractor

Occupancy	Units	Qm3 (min/max)
Up to 4 people	1	175/700 m3
Up to 12 people	2	350 - 1400 m3

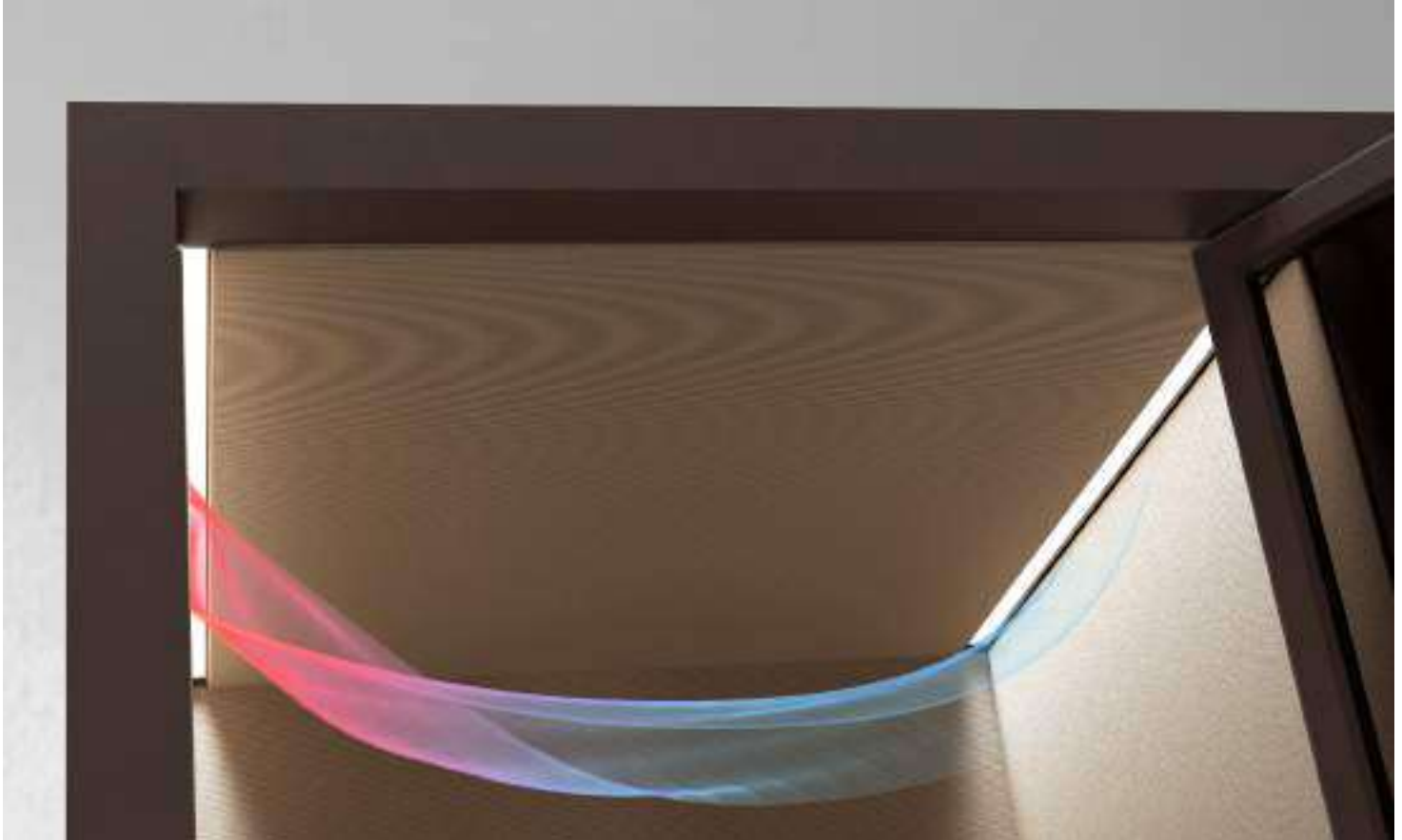

Room Flow air conditioning

# Connection

## Description

---

The electrical system within the Pavilion O is designed to be discreet, elegant and practical. Embedded in the structure, it is easily accessible and is thought within the design.



Control center



Socket End points



Pavilion connection point

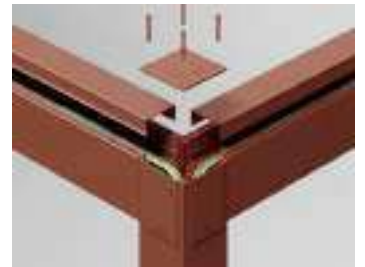

Easy access in-wall wiring

# Wall mounted outlets

## Key functions

- Data Port
- HDMI
- Power Outlet
- USB
- Configurable
- Shatter-proof
- Flat design line

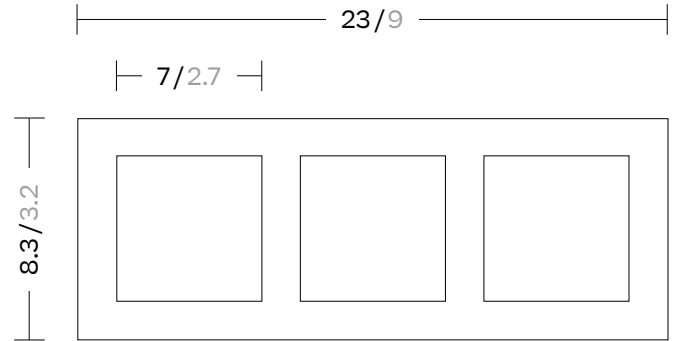

Cm/Inches



# Table mounted outlets

## Hardware

---

- Simple design
- Power Connections
- USB

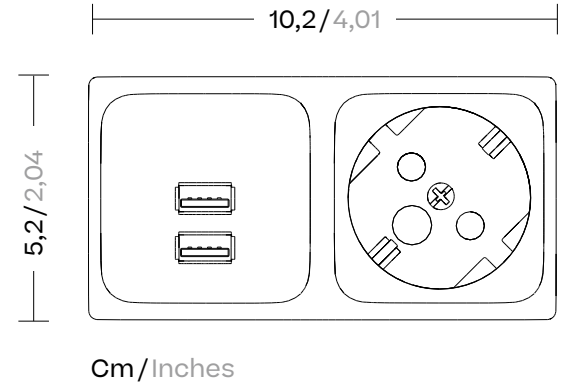

# Acoustic side panels

## 44 db

### Description

All our panels are tested to ensure they meet the required acoustic levels. We have tested some of the wall combinations to provide guidelines with regard to acoustic levels. Acoustic performance varies depending on the material selection for each wall.

The O glass version offers excellent acoustic performance, creating a comfortable and efficient working environment. It is based on 3+3 and 6+6 laminates with a soundproofing membrane to provide an impressive acoustic performance of up to 44dB. We also offer a range of solid wall options in fabric and wood. Many of these alternative wall options offer excellent acoustic performance properties. Our laminated panels not only provide additional acoustic performance, but also come in a range of colors. As a result, you can customize your Pavilion O to reflect your brand image or simply to create a bright office space. In addition, the eco-friendly panels reduce and control reverberated noise within the Pavilion, further enhancing the overall soundproofing performance.

### Key functions

- Fire retardant M1
- Memory acoustic foam
- Easy clean material
- Odor free and antimicrobial



Acoustic Panel Comfort (36 db)

---

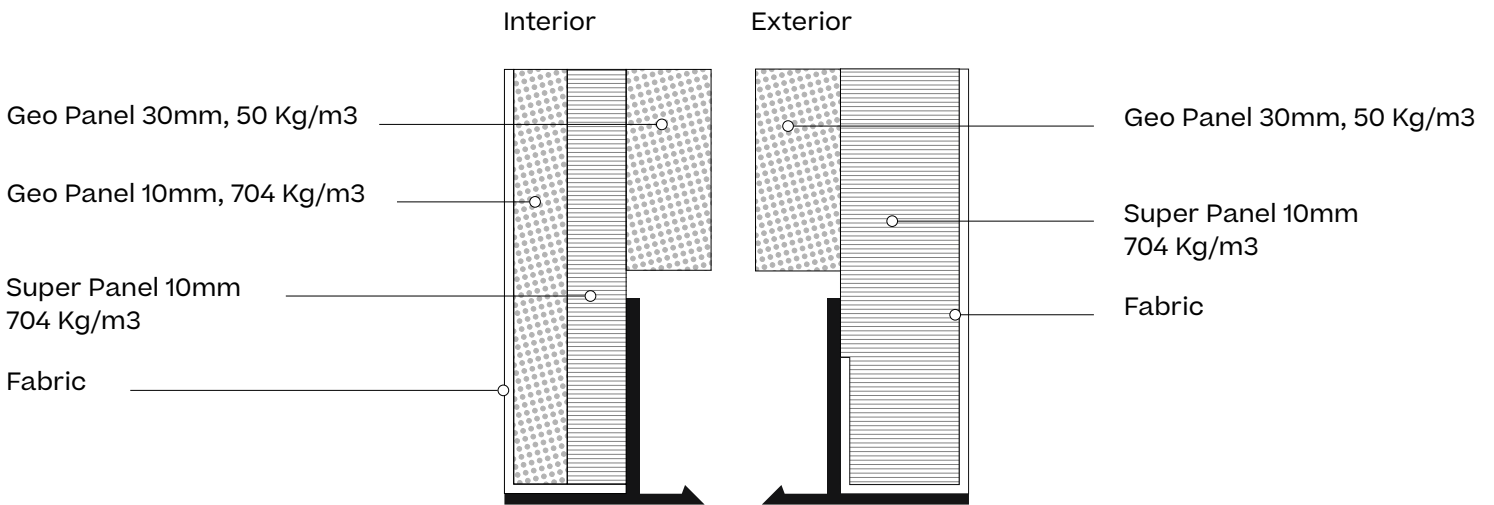

Acoustic Panel Plus (44 db)

---

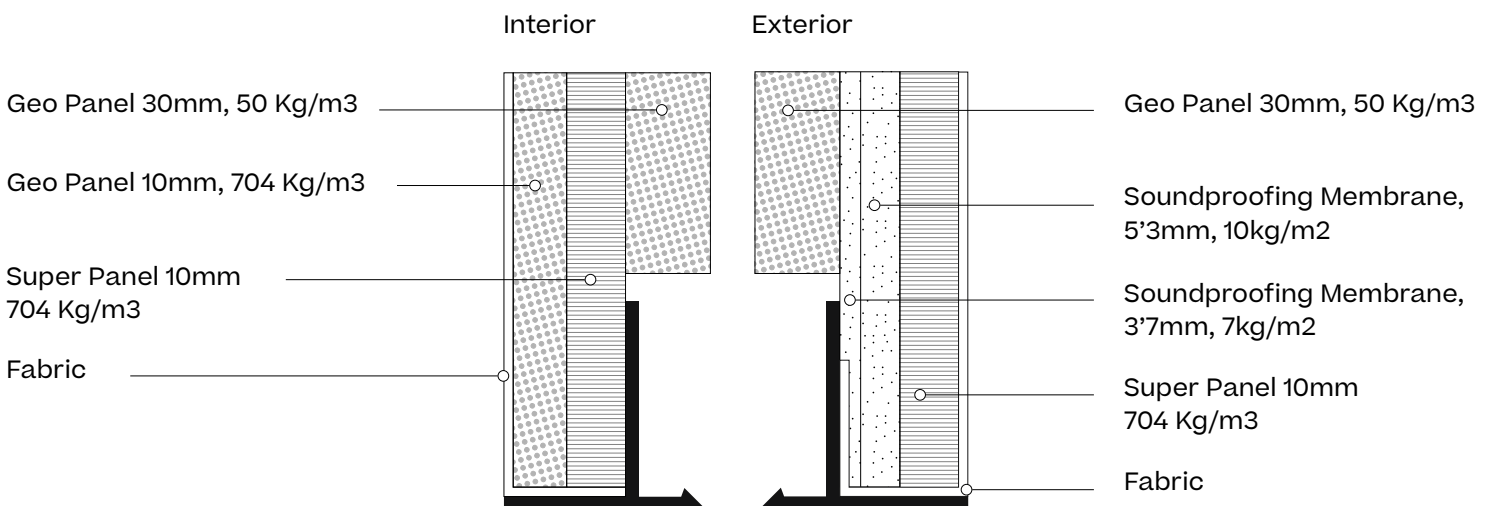

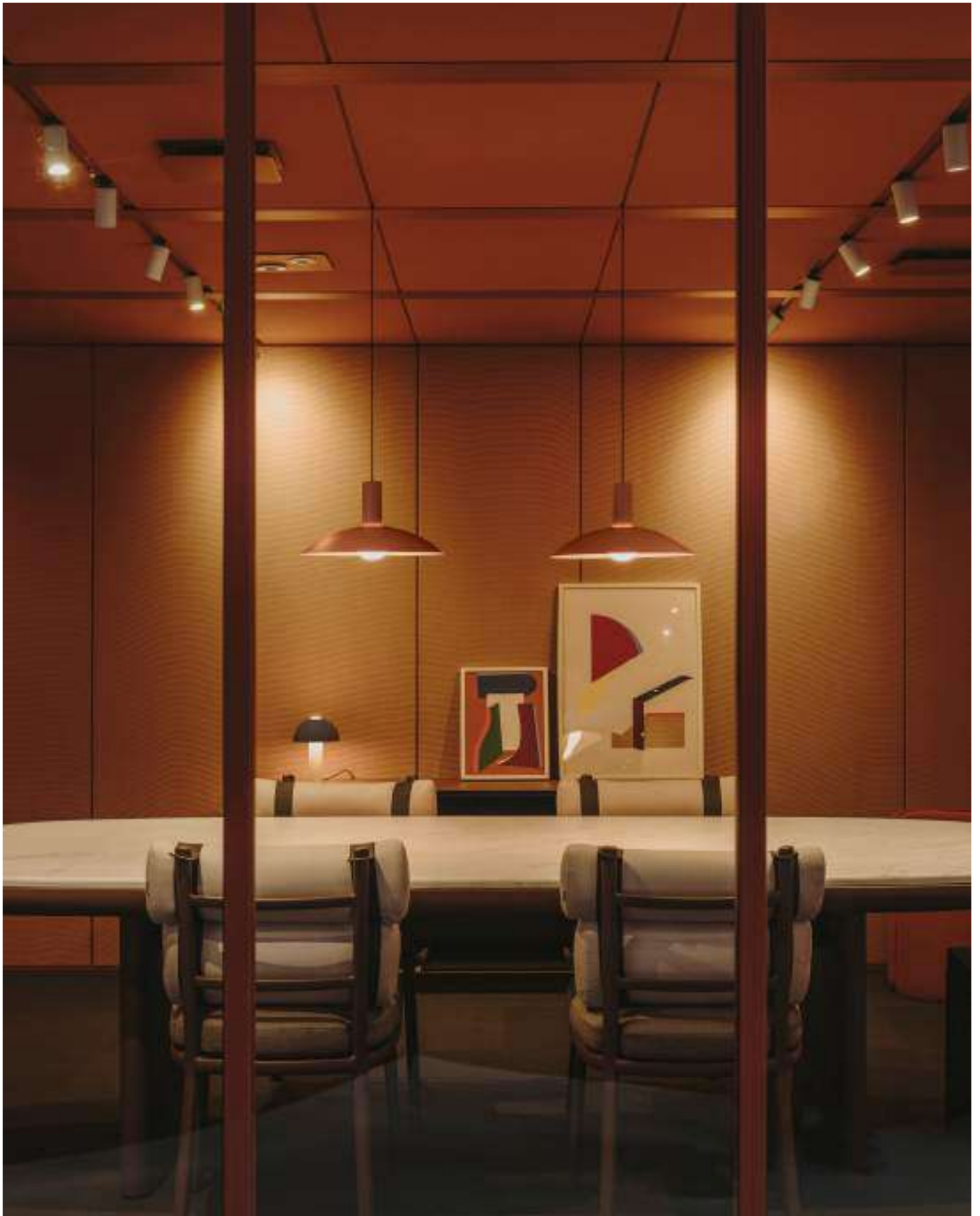



Ceiling Panel

32 dBa

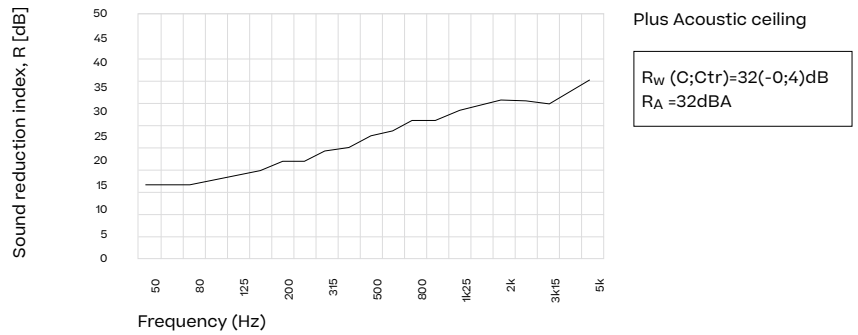

Acoustic Side Panel

Comfort Plus  
36/44 dBa

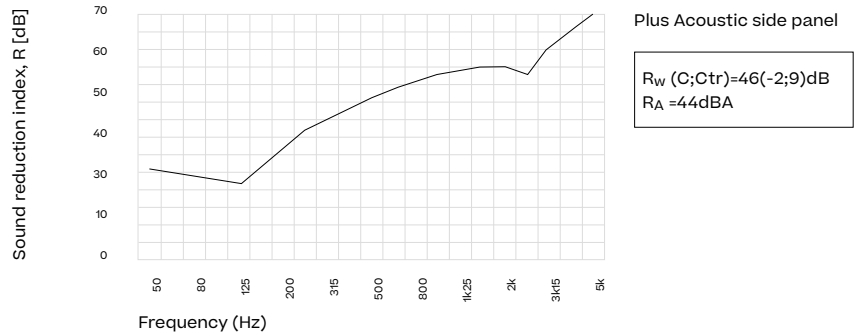

Acoustic Glass & Glass Door

Comfort Plus  
35/40 dBa

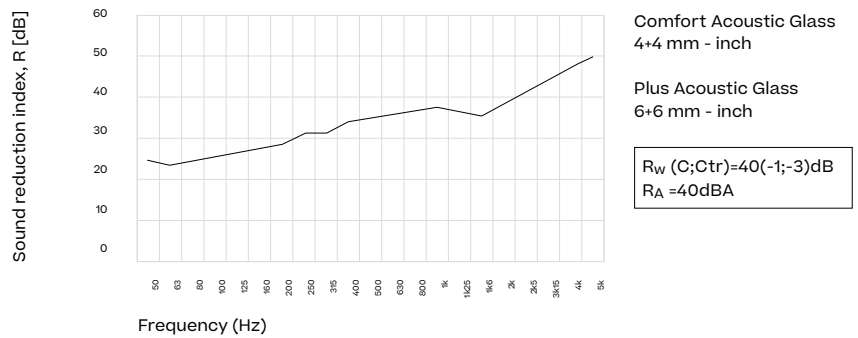

Average reverberation

0,2 RT

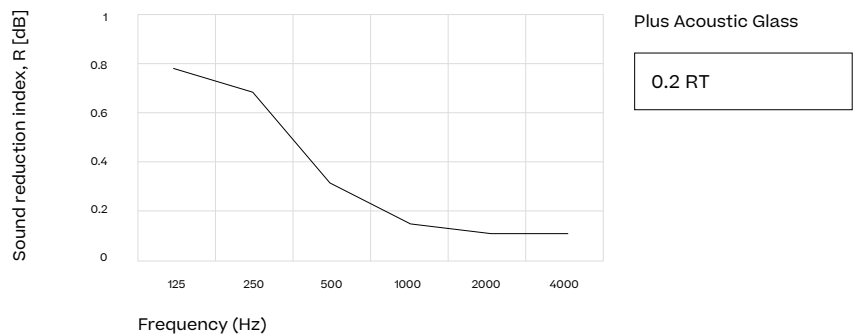

# Lighting

A space cannot be designed without careful consideration of lighting. For this reason, we have created a new language of light, from the ground up, that elegantly integrates into the architecture.

We are not just another lighting company. But we know an adequate amount of light and a clever placement improves mood and energy levels, which is essential to consider in the well running of the workspace.

This lighting system is adaptable to all situations: conversation, concentration, relaxation and more. Form, function and performance is driving the fusion of technology and emotion.

Elegantly integrated lighting  
that rounds out your workspaces.

# LED Track Curtain

A recessed lighting system equipped with an LED light source. Specially designed for wall-washer lighting, the LED Curtain incorporates lenses to provide optimum light distribution. The LED Curtain range is available in different lengths which means it can be adjusted to suit any space, while its compact size facilitates simple integration within the Pavilion O system.







# LED Track



An integrated LED lighting system that offers solutions suited to any type of installation. It provides pleasant and efficient visual comfort, combined with high-quality performance and aesthetics.

# LED Track Suspension





This system consists of a bar that combines direct or indirect light, suspended by two coaxial cables that provide support and the electrical wiring. Perfect for offices that require excellent light efficiency and visual comfort.



Workplace



Our surface-mounted range that uses an LED light source. This system is composed of linear LED strips mounted on aluminum extrusion micro-profiles of varying lengths. These light modules are combined with adjustable 360° Dots spotlights that are available with different beam optics.

# LED Track Articulated



Workplace

# Dots Pendant



## Lighting

This suspended light is based on the Dots spotlight system. With its two open and closed diffusers, it directs most of the light downwards. By directing most of the light downwards, the shade is molded to illuminate spaces while protecting peoples' eyes from any direct glare. The matte white interior of the elliptical shade helps create a uniform light that is ideal for both directed and general ambient lighting needs.







Workplace

# Dots Phone Booth





## Lighting

The Dots Phone Booth is a professional table lamp with direct light. The base and diffuser is made of colored aluminum. It exceeds common lighting standards for applications in work and study environments.



(only on demand)

# Tracks system

## Integrated



LED track curtain Integrated



LED track integrated



LED track slats integrated

## Pendant/Wall Curtain



LED track



LED track curtain

# Dots system

## Ceiling



Dots pendant (open/close)



Dots articulated



Integrated microdots

## Integrated



Dots light up



Dots light down



Table Dots lam  
(Phone booths only)

# Dots Floor

Dots lamps, manufactured in aluminum with LED lights, are available in two versions: a floor lamp with a circular base and planter lamp with a base that can be fastened to the product. The new Dots lamps have been developed for indoor and outdoor use. The height and direction can be adjusted to focus the light where it is needed.





# Half Dome



The Half Dome is a great mountain with endless variations of lighting, sky situations and seasonal characteristics – the many images of which reflect the varied creative responses to this remarkable granite monolith. The moonlight has a particular size of diameter as people imagine it. The dimension of the Half Dome light follows our image of the moonlight size.



# Dots Wall/Column





The Dots wall luminaires feature LED light sources and project light above or below the horizontal plane for an authentic washlighting effect, ideal for selectively illuminating corners, specific spaces, facility corridors, as well as walkways, access routes, signs and so on.



# Furniture

We offer a wide range of durable products that allow you to create work environments and public spaces that are suitable for a wide variety of uses, both for individuals and for teams. These products also allow you to create areas where people can work in silence and with complete concentration.

The furniture collection, which is suitable for both indoors and outdoors, is lively and expressive. They feature modern classic designs, with an informal and stimulating language, enriched by contemporary colors and materials.

Versatile and timeless furniture designed by the most important names in the international design scene.

# Roll, by Patricia Urquiola



This ironical intervention on the conventional upholstery converts a regular backrest into two independent 'wraps' connected by colorful straps. A graphical aluminum structure frames the protagonist of this chair, the cushions.



Workplace





Workplace





# Band, by Patricia Urquiola



The idea behind the Band collection is the breakdown of structure. An object designed using an esemble of pieces. The chair's design intentionally challenges the classic sophisticated lines of furniture design and becomes something schematic, a conceptual program.

A structure made up of repetitive angular shapes that give center stage to its raw materials and can be formed entirely of aluminum, teak wood or Terrain Fabrics.

Workplace





Workplace

# Stampa, by Erwan & Ronan Bouroullec

A calyx shaped metal shell is inhabited by carefully organized holes made by the technique of punching metal sheets.



# Park Life, by Jasper Morrison





Park Life is a complete family of furniture for outdoors, whose clean-cut profile is adaptable to a wide range of different situations. Lightweight yet extremely durable, it is easily stacked for transport or winter storage. Its technical sophistication and careful consideration of ergonomics, as well as the great care Jasper Morrison took over how it looks, combine to ensure a long life, both structurally and visually.

Workplace







# Basket, by Nanna & Jørgen Ditzel



Kettal edits the Basket chair, created in the 1950s by Danish designers Nanna and Jørgen Ditzel. The Basket chair comes in its original Ditzel oak version which is hand-braided in wicker as well as an outdoor version made from artificial fiber and teak.



Workplace

# Riva, by Jasper Morrison





The Riva collection of outdoor furniture is above all about achieving a certain atmosphere for the better enjoyment of outdoor space. The plank construction of seat and back follows a long and varied tradition of outdoor chairs made in similar way and which, in this case, provides a high level of comfort and good looks!

Workplace

# Boma, by Rodolfo Dordoni



## Furniture

The Boma collection, designed by Rodolfo Dordoni for Kettal, was born from the need of high performances of outdoor environments without sacrificing the increasing demand for comfort that new products have to face.

Therefore, the structure is organized around a frame entirely made of aluminum, capable of hiding in the essentiality of its lines both the quality of the materials used and the possibility of easy articulation in different compositions.



Workplace

# Molo, by Rodolfo Dordoni







This is an example of a modular sofa in its purest form. Its orthogonal geometry is based on rectangular modular design which means it can be easily adapted to suit any situation and optimize the space in which it sits. Each module can be taken apart and reorganized to create new uses and configurations. The design is aesthetically minimalistic with intentionally oversized pieces.

On the other hand, the decorative elements have conscientiously not been emphasized in order to give center stage to the various combinations of fabric, colors and carefully selected details.

“Molo, or pier in English, jetée in French and embarcadero in Spanish, is a structure built on the shores of an ocean, sea, lake or river which extends from the land over the water; a mooring place for boats, a rest between trips and a refuge from the swell of the waves. A return to terra firma and people. Molo offers a place of relaxation and reconnection.”

Rodolfo Dordoni

Workplace

# Cala, by Doshi Levien





Cala is a high-backed armchair inspired by the iconic Emanuelle.

This chair has a majestic spatial presence with transparent and light surfaces. The open weave of the rope provides a latticed window for visual privacy while maintaining a connection to the natural elements. Cala may be used for outdoor dining as well as a chair to lounge in. The wide selection of metal coatings, rope colors and cushion fabrics offer many possibilities to tailor the identity of the chair to suit different projects.

# Village, by Jasper Morrison

A collection for all outdoor situations, from village house to grand café. The lightweight aluminum structure allows easy handling while the neutral language of its form takes nothing away from the scenery. This chair pays respect to the long standing codes of metal stacking outdoor chairs while gently refreshing the look.





Workplace

# Net, by Kettal Studio



## Furniture

The Kettal Net collection conserves a classic structure with its elegant and smooth lines that give a calming and attractive appearance. Woven cords and aluminum tubing come together to provide a light, handcrafted look.



# Sofa O, by Kettal Studio

The “O” series of Sofas combines maximum comfort, minimum details and optimal flexibility in a timeless design. Its simple and smooth shapes can be incorporated into any context. The range of functional modular units allows full customization with corner modules or additional seats to suit any space or purpose, while upholstery options with Kettal's selection of fabrics allow the sofa to find its own personality.







Workplace

# Sideboard





The sideboard idea is to create a single autonomous monoblock which can contain all the the necessary elements for your workplace. It can house anything from a refrigerator to office supplies and objects. When its doors close, the sideboard goes back to its perfect block shape.

It is made with extruded aluminum profiles, with Honeycomb side walls, and gray powder coated metal sheet. The sliding doors can be made of teak, wood or oak, and powder coated metal sheets.

The sideboard places special emphasis on the materials and colors of the sliding doors, underlining its elegant proportions and giving a cheerful and carefree touch.

# Materials

The materials in the new collection of the Pavilion O system are represented by fabrics, metals, woods, stones and ceramics. All of these worlds form the basis of the library. The intention is to inspire and invite the professional to explore and combine colors, textures and materials to create new exclusive codes for each project and each use.

Recyclable and exclusive materials,  
to explore an infinite number  
combinations.

# Material technical specifications

Material	Certifications	Proximity	Application
Structural Aluminium	EPD	< 100Km	Structure+Panels
Super Panel	FSC PEFC Formadely Free C2C TYPE 2 EPD	< 100Km	Panels
Terrain Coatings	REACH, Qualicoat	< 150Km	Structure+Panels
Sound Proofing Membrane	REACH	< 400Km	Fabric Wall Panel + Ceiling Panels
Geo Panel	ROHS	< 400Km	Fabric Wall Panel + Ceiling Panels
Soundproof Safety Glass	C2C BRASS	< 100Km	Wall Panel + Door
Terrian Fabrics	Greenguard	< 100Km	Fabric Wall Panel
Electrical components	ISO 9001	Europe	
All around	ISO 14001 REACH EMAS	Europe	

## Material

### Aluminium

The Aluminium 6063 T5 has extruded and hollow profiles of this alloy will be used to build up the structures of each booth.

This is a light and ductile alloy, with great strength and magnificent finishing characteristics. It is ideal for works that require high quality and perfect finishes. It has excellent corrosion resistance, similar to that of stainless steel. Follows the UN-EN-AW 10204 3-1 regulation. Kettal uses 80% recycled aluminum in the extrusion of its profiles in order to reduce greenhouse gases, thus contributing to a more sustainable production of our customers' products.

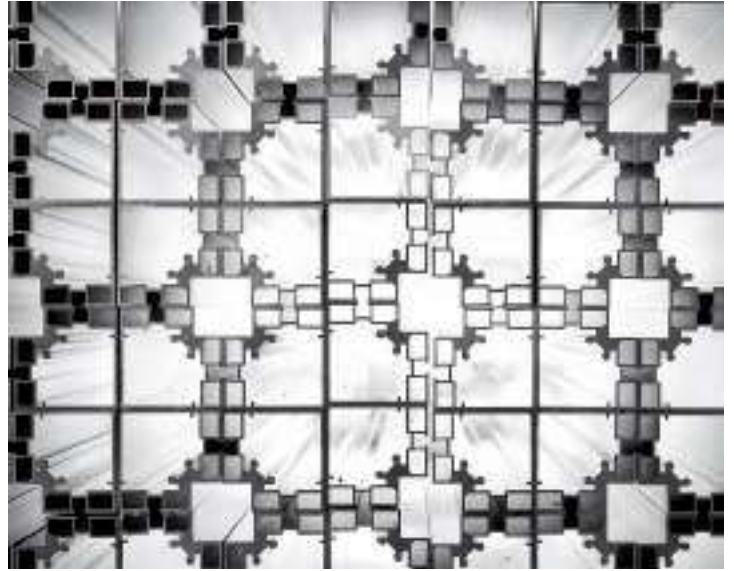

Chemical composition  
(UN-EN 10204 3-1 Regulation)

%	Min.	Max.
Si	0.30	0.60
Fe	0.10	0.30
Cu	-	0.10
Mn	-	0.10
Mg	0.35	0.60
Cr	-	0.05
Zn	-	0.15
Ti	-	0.10

### Certificates & features



Recyclable



80%  
recycled



Local supplier

Soundproof Safety Glass

Our laminated safety glass is made of two or more glass panes joined by one or more coats of polyvinyl butyral (PVB). In the event laminate glass breaks, the PVB coating holds the majority of the glass fragments, meaning the residual strength and hold of the glazing keep them in place until being replacement.

This type of glass filters 99% of UV rays and helps extend the service life of curtains, rugs, fabrics, objects, etc. that are exposed to natural light on a daily basis. It offers protection when there is a need for safety and complies with the requirements of current norms and regulations for homes, shops, or offices.

6mm / 1 PVB CLEAR /6mm (plus)  
 4mm / 1 PVB CLEAR /4mm (comfort)



Special characteristics	AVCP systems	Performance
Resistance to fire	1	NPD
Reaction to fire	3.4	NPD
Performance benefits against external fire	3.4	NPD
Resistance to swinging objects	3	2B2
U value	3	NPD
Light transmission	3	0.89
Light reflection	3	0.08/0.08
Transmission of solar energy	3	0.78
Reflection of solar energy	3	0.07/0.07
Durability	3	PASS

Certificates & features



In the event of breakage, the fragments stay stuck to the laminate



Type of break



## Material

### Terrain Coating

Electrostatic powder coating process applied. This paint mixes a specific resin that offers greater hardness compared to the paints used in architecture. Terrain Paints are designed to coat aluminium profiles used in architecture and for other substrates where the maximum resistance to the outdoors is needed.

This is a powder coating formulated with polyester resins and free of TGIC, pigments, and additives. These provide excellent exterior durability with very good gloss retention and colour stability.



Characteristics	Min.	Max.	Method
Baking time / temperature	24 to 150 °C / 75,2 to 302 °F	26 to 150 °C / 78,8 to 302 °F	Total time
Gloss at 60° angle	6	9	ISO 2813
Direct impact 12.5 mm	30		ISO 2813
Indirect impact 12.5 mm	30		ISO 2813
Cross-cut adhesion	0	0	ISO 2813
Erichsen Cupping test	5	11	ISO 2813
Bend test (Cylindrical Mandrel)		6	ISO 2813
Avg. Particle size	50	55	MALVERN
General appearance	Textured		NIZI-001

### Certificates & features

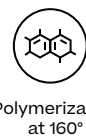
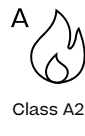

## Kvadrat Relate Fabrics

Relate is a sophisticated twill weave upholstery textile designed by Patricia Urquiola made from Trevira CS, which has a soft hand resembling natural fibres.

The versatile palette for Relate comprises 35 colourways and expresses confident colour combinations by combining warm notes with closely related nuances.

Relate is suitable for contract and private use.



Composition	100% Trevira
Width	Approx. 140 cm
Weight per m <sup>2</sup>	Approx. 328/m <sup>2</sup>
Fire test	AS/NZS 3837 class 2, BS 5852 Crib 5, BS 5852 part 1 with treatment, DIN 4102 B1, EN 1021-1/2, IMO FTP Code 2010 Part 8, NF D 60 013, NF P 92 503 M1, NFPA 701, SN 198 898 5.2, UNI 9177 Classe 1, US 1 Cal. Bull. 117-2013, ÖNORM B1/Q1
Lightfastness	5-7 (ISO 1-8)
Shrinking	App 2%
Abrasion Martindale	80.000 Martindale
Wash load	Half
Pilling	4-5 (ISO 1-5)
Colour	Slight differences may occur
Produced in environment	Greenguard Certification <a href="http://www.greenguard.org">www.greenguard.org</a>

## Material

### Terrain Fabrics

---

This is a range of premium fabrics for indoor and outdoor furniture. The hydrophobic technology applied works by impeding the liquids that permeate the fabric, forcing them to roll out of the fabric in the form of drops. The fabric protection that brings out the liquids allows for drops of water and oil to be eliminated during normal washing without leaving any traces. Solution-dyed acrylic; is dyed before thread is created. A liquid acrylic solution is mixed with dye and then formed into a fiber and spun on thread.



Composition	100% acrylic, dyed	
Width	160 cm	
Weight per m <sup>2</sup>	400 g/m <sup>2</sup>	ISO 2286-2
Oil resistance	6	AATCC 118
Colour fastness to artificial weathering	7-8 blue scale (8)	ISO 105-B04
Colour fastness to light	7-8 blue scale (8)	ISO 105-B02
Abrasion resistance (Martindale)	50,000 cycles	ISO 12947-2
Abrasion resistance (Wyzenbeek)	15,000 double rubs	ASTM D4157
Cigarette ignition classification	Class 1	NFPA 260
Material resistance to ignition without flame	Pass	CA TB 117

### Certificates & features

---



Type 2  
From cradle  
to gate with  
options



30% Bleach  
80% Water



Ironing  
reactivates  
the finish

## Soundproofing Membrane

Our soundproofing Membrane is high-density, polymer-based, and asphalt-free synthetic, to obtain optimum acoustic performance. The effect of this soundproofing membrane is to deaden structure born vibrations by adding mass to your existing surface.



Characteristics	Testing Method	Sound Proofing Membranesy	Units
Density	-	2.010	Kg/m3
Tensile strength	NT-67	>30	N/50mm
Elongation	NT-67	>500	%
Fold	EN 1109	-20	°C
Fire Classification	UNE-EN 13501-1	Bs2d0	-
Resistance factor to water steam	UNE-EN 1931 met B	μ>1806	-
Water absorption (24h at 23°C)	1S062 met 1 NT74	0,003	%
Shore A hardness	NT74		

## Certificates & features

Regulation or protocol: French VOC Regulation/French CMR components / AgBB/ ABG/ Belgian Regulation/Indoor Air Comfort®/Indoor Air Comfort GOLD®/Blue Angel (RAL UZ 132)/BREEAM International/LEED v4 (outside U.S.)

No substances including in the list of prohibited substances in cradle to cradle certified products program are used in the manufacturing of the product range sound proofing membrane so those substances are not expected to be on the final product.

## Material

### Compacted Wood

Compacted Wood is a compacted wood particle board. These wood particles come from the remains of FSC certified forests.



Properties	Test method	Units	Thicknesses mm				
Density (*)	EN 323	kg/m <sup>3</sup>	740	710	695	675	660
Internal bond	EN 319	N/mm <sup>2</sup>	0.40	0.35	0.30	0.25	0.20
Bending strength	EN 310	N/mm <sup>2</sup>	11.0	11.0	10.5	9.5	8.5
Thickness swelling 2 h	EN 317	%	6	6	6	6	6
Formaldehyde emission class e1	EN ISO 12460-3	mg/(m <sup>2</sup> .h)	≤ 3,5	≤ 3,5	≤ 3,5	≤ 3,5	≤ 3,5
Reaction to fire	EN 13501-1	Euroclass	B-s1,d0 (!)	B-s1,d0 (!)	B-s1,d0 (!)	B-s1,d0 (!)	B-s1,d0 (!)
Sound absorption coefficient (α) (250 a 500 hz)	EN 13984:2004+A1:2015	α	0.10	0.10	0.10	0.10	0.10
Sound absorption coefficient (α) (1000 a 2000 hz)	EN 13984:2004+A1:2015	α	0.25	0.25	0.25	0.25	0.25
Thermal conductivity	EN 13984:2004+A1:2015	W/ (m.K)	0.15	0.14	0.14	0.14	0.13
Biological durability use	EN 335	Class of use	1	1	1	1	1
Content of pentachlorophenol (pcp)	EN 13986:2004+A1:2015	ppm	< 5	< 5	< 5	< 5	< 5

### Certificates & features

The material is fire retardant, its treatment with resins provides a low degree of flammability, for which it is classified as M1 according to the UNE23727 standard and as B-S1 according to the UNE EN 13501-1 standard

## Geo panel

---

The Geo Panel is an ecological product. It is Bio-sustainable: 80% made of recycled material, and 100% recyclable. It is safe in its installation: It does not cause discomfort or itching as it is based on natural fibers. The Geo Panel is an elastic product. It does not break when folding. Its modulus of elasticity compared to rock wool is 7 times better.



Frequency	Rockwool 4cm	Cotton 3 cm
100	40,7	43,8
200	43,8	42
250	46,8	33,2
400	47,2	46,8
500	47,8	53,3
1000	54,4	54
1250	55,6	56,8
1600	56,6	57,5
2000	59,3	60,1
2500	61	61,2
3150	64,3	66
4000	66,1	68
GLOBAL	53 dBA	54.6 dBA

## Certificates & features

---

It does not promote combustion.  
Fire classification: M1 Certified  
09/32300075 and 76 + according to  
UNE 23721-90, EN 13501-1.



Recyclable

## Material

### Super Panel

---

The technical wood is one of the main components to create the acoustic lateral panel and ceiling. It has a 10mm fire-fighter, and complies with E1 regulation.



Characteristics	Test	Units
Density	EN 323	kg/m <sup>3</sup>
Flexural strength	EN 310	N/mm <sup>2</sup>
Formaldehyde emission	EN 717-1	ppm
Reaction to fire	EN 13501-1	Euroclase
Absorption acoustic coefficient	UNE EN 13986: 2006+A1:2015	α
Acoustic insulation	UNE EN 13986: 2006+A1:2015	db
Biological durability	UNE EN 335	Clase de uso

### Certificates & features

---

The environmental product declaration is in accordance with ISO 14025 and EN 15804. It complies with standards EN 622- 1, EN 622-5 and EN 14322. They are considered reliable products use as raw material for the construction and furniture industry.



Type 2 / From cradle to gate with options



Formaldehyde free



Local supplier

# Material finishes





# Workplace

## Terrain Fabrics



White Cliffs  
258



Dry Sand  
251



Porous Grey  
259



Limestone  
260



Fog  
257



Deer  
252



Arctic  
274



Fjord  
283



Cerulean  
280



Caribbean  
273



Atlantic  
272



Rainforest  
275



Summer Sky  
284

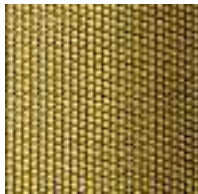

Golden Sand  
262



Flamma  
263



Sunrise  
264

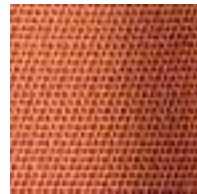

Saffron  
265



Burnt Sienna  
266



Wet Sand  
254



Cobblestone  
255



Cyprus Umber  
253



Loam  
256

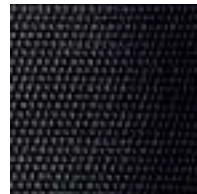

Charcoal  
261



Lagoon  
276

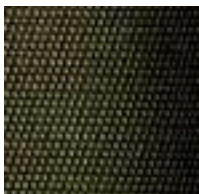

Cedar  
279



Moss  
277

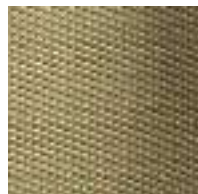

Olive  
278

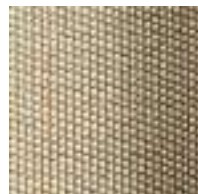

Autumn  
281



Ash Rose  
267



Cooper  
282



Dusk Pink  
268



Flamingo  
271

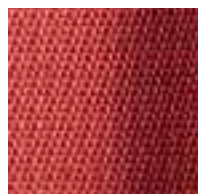

Coral  
270



Sandstone  
269

# Material

## Kvadrat Relate Fabrics



0101



0111



0121



0151



0161



0171



0181



0191



0201



0221



0271



0341

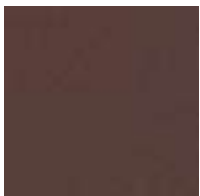

0371

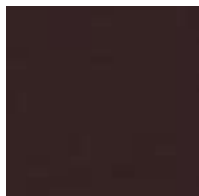

0381



0401



0431

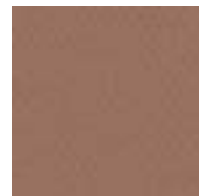

0441

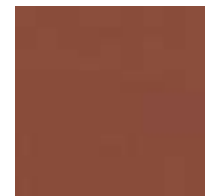

0461



0561

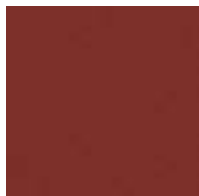

0571



0611



0641

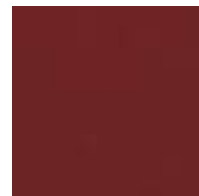

0671



0691

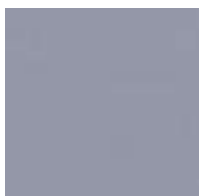

0711

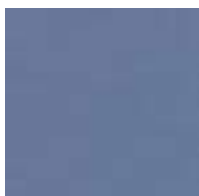

0741

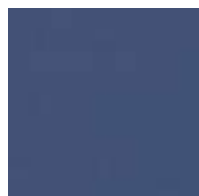

0771

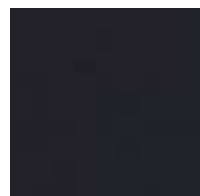

0791



0821



0881



0921



0941



0961



0981

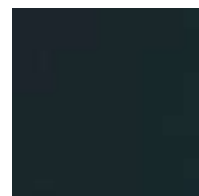

0991

## Workplace

## Maya



0119



0129



0139

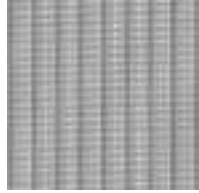

0149

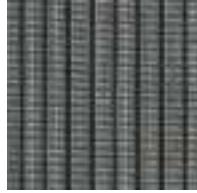

0199



0219



0229



0379



0429



0619

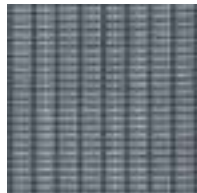

0789

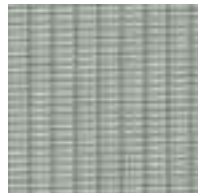

0949

## Parallels



White Anemone  
527



Lace Coral  
528



Padina  
564



Saline  
571



Alaria  
572



Sponge  
536



Fucus  
537



Urchin  
547



Kelp  
556

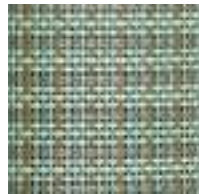

Turtle Grass  
553



Deep Ocean  
570



Winter Sea  
569



Xenia  
568



Plumaria  
567



Irish Moss  
559

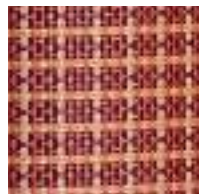

Coral  
562



Dulse  
565

## Material

### Geometric Fabrics



Umbra Brown  
192



Dash Brown  
162



Shade Brown  
152



Dots Brown  
142



Dots Light Brown  
147



Umbra Green  
191



Dash Green  
161



Shade Green  
151



Dots Green  
141



Dots Light Green  
146



Umbra Grey  
193



Dash Grey  
163



Shade Grey  
153



Dots Grey  
143



Dots Light Grey  
148



Umbra Blue  
190



Dash Blue  
160



Shade Blue  
150



Dots Blue  
140



Dots Light Blue  
145



Umbra Red  
194



Dash Red  
164



Shade Red  
154



Dots Red  
144



Dots Light Red  
149

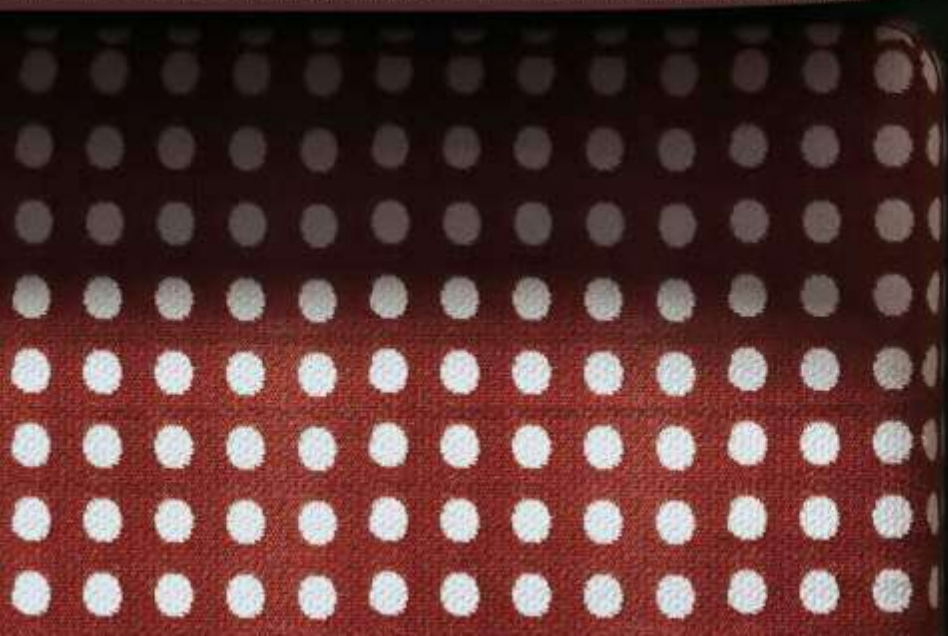
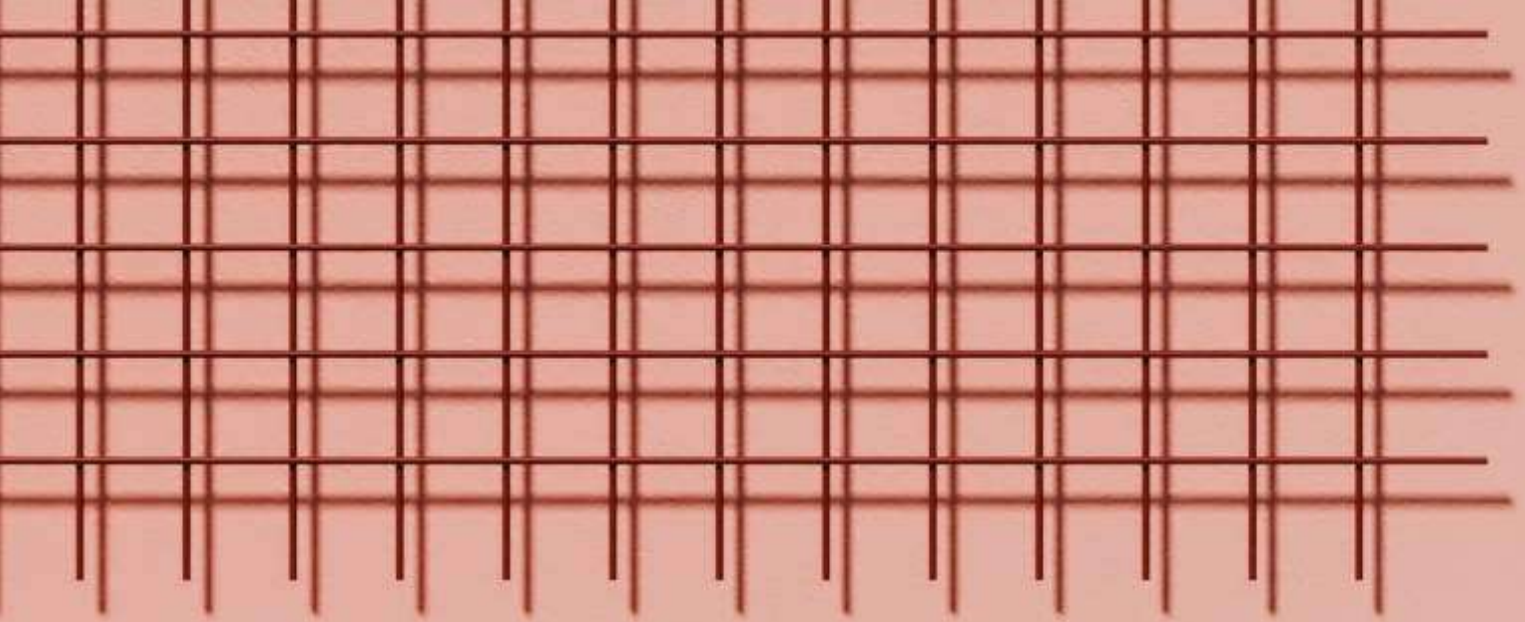



## Workplace

## Terrain Paint



Chalk  
721



Bone  
678



Tuff  
103



Mist  
773



Flint  
734



Mahogany  
100



Carbon  
737



Camomile  
106



Sahara  
139



Terracota  
085



Magma  
086



Terra Rossa  
087



Sepia  
088



Lilac  
104



Feldspar  
082



Aquamarine  
107



Cobalt  
089



Indigo  
094



Jade  
091



Onyx  
101



Juniper  
092



Amazon  
102

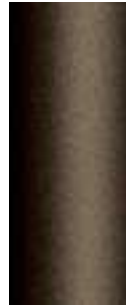

Bronze  
093



Corten  
727



Claystone  
741



Sand Storm  
132



Pumice  
131



Galena  
105



Manganese  
726



## Material

## Ceramics



Bianco



Blu Cold



Rosso cold



Verde scuro



Ceppo di Gre



Du Gent Grey



Statuario White



Royal Black

## Glaze paints



Erinite  
376



Montana  
377



Indian Sapphire  
371



Dolomite  
258



Obsidian  
372



Jasper  
375



Black Diamond  
374



Smoky Quartz  
370

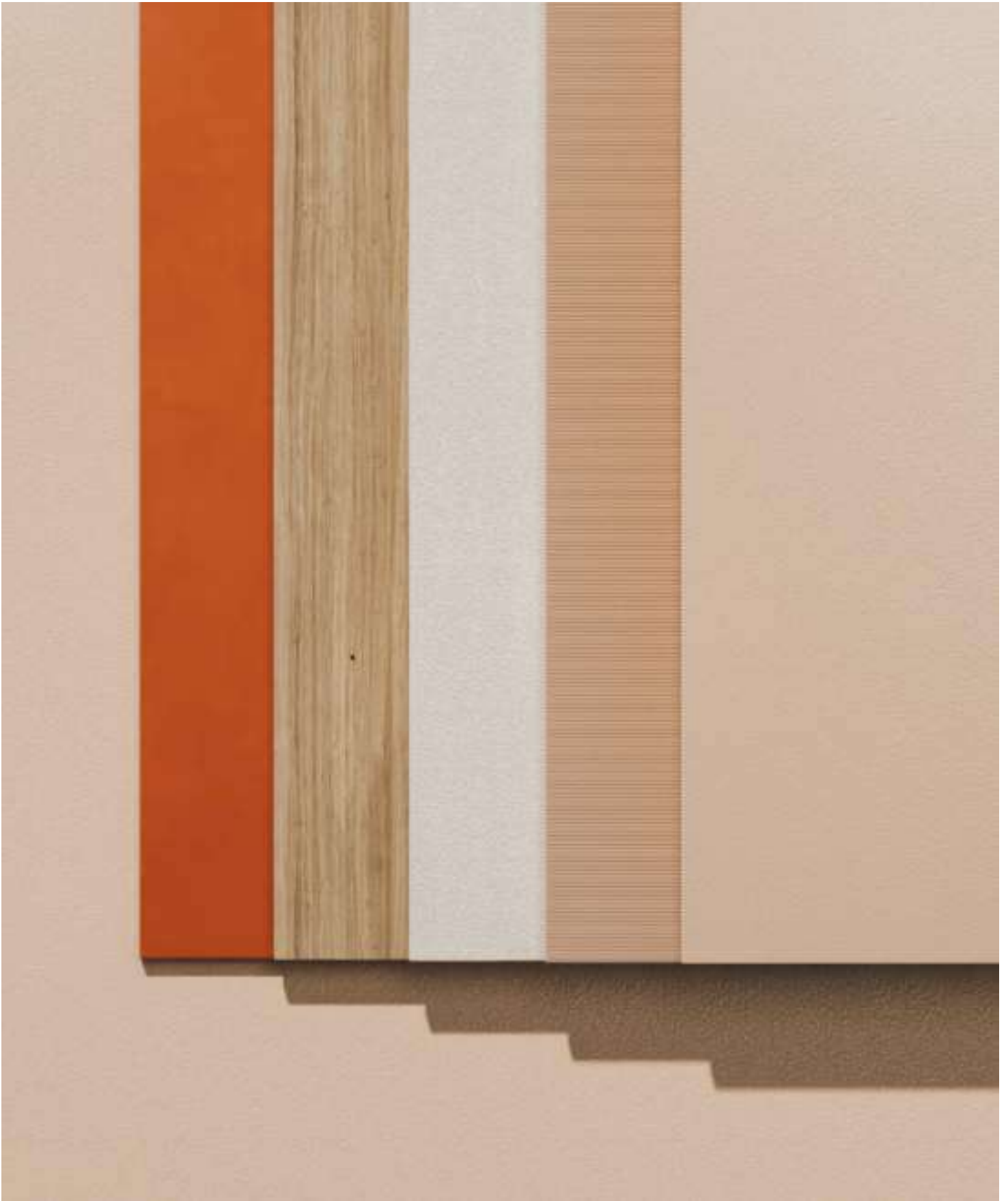

## Material

### Wood

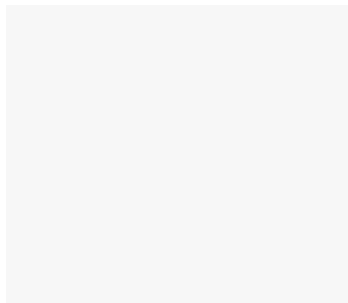

Soft White



Waxed Oak



American Walnut



Teak

### Leather



Light Brown  
350



Dark Brown  
352



Taupe  
351

### Floor



Bergen

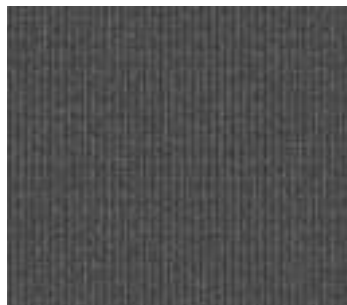

Reykjavik



Nordkapp

# Workplace

## Plain Bela rope



Snow Bird  
434



Silver Leaf  
421



Woodland  
441



New Dawn  
452

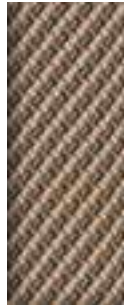

Honeysuckle  
453

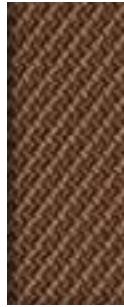

Forest Bell  
451



Oberon  
432



Jasmine  
431

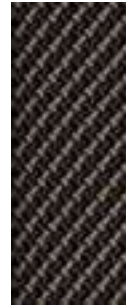

Ivy  
433



Emerald  
425



Blue River  
422



Alpina  
423



Romantika  
424



Wisteria  
414



Rosa  
413



Campsis  
411



Virginia  
412

Material

Round Bela rope



Snow Bird  
434



Silver Leaf  
421



Silver Leaf  
421



New Dawn  
452



Honeysuckle  
453



Forest Bell  
451



Jasmine  
431



Oberon  
432



Ivy  
433



Emerald  
425



Blue River  
422



Alpina  
423



Romantika  
424



Wisteria  
414 290



Rosa  
413



Campsis  
411



Virginia  
412

# Ecological awareness. To buy responsibly means to keep for a longer time.

For us at Kettal, ecology is not marketing. It's a very serious matter. We have analyzed the variants of product life cycle to minimize environmental impact as far as possible. Not only in our raw material usage, but also other variables such as CO2 emissions from transport or use and durability.

Raw materials: Not only are they recyclable but also recycled. We study the impact of the material over time. There is no point using a very ecological material if, due to its construction, it needs to be replaced many times during the product's life cycle, thus multiplying the pollution caused by its production process.

Okm production: Trying to produce all components close to our Kettal production center in Barcelona is one of the brand's objectives to reduce CO2. The essential raw materials used at Kettal, such as fabric, rope and aluminum, are produced within a radius of 100km.

Use and durability: We do not build in obsolescence. Each design is aesthetically designed and technically developed to last as long as possible. The longer a product lasts, the less often it has to be replaced and therefore the fewer production processes that have to be carried out.

Accordingly, we at Kettal keep technical drawings and product patterns that are 30 years old in order to be able to replace components and extend the life of the product.



Kettal is developing and manufacturing the Pavilion O systems in Europe with a straight focus on the LEED standard requirements.

Kettal Quality & Certification management team is coordinating the LEED Certification process with an external LEED specialist consultant.



Selection of local partners and suppliers (Short Distance Supply Chain).



Selection of long life cycle manufacturing components and techniques (Aluminum, coating, fabrics, foams, secured glass).



Selection of environmental certified materials (OekoTEX, EPD, FSC).



Selection of recycled and/or recycled materials (Recycled aluminum, recycled foam, recycled fabric).

# Recycled & Recyclable

Aluminium  
structure



Super Panel



Relate fabric



Glass



Maya



Ceramic

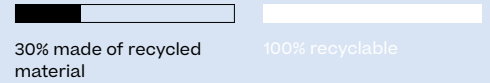

Bela Ropes



Compacted  
Wood



Geopanel



Stainless steel



Soundproofing  
Membrane



Terrain  
Coating



Terrain Fabrics



(recommended materials)



# Life cycle analysis

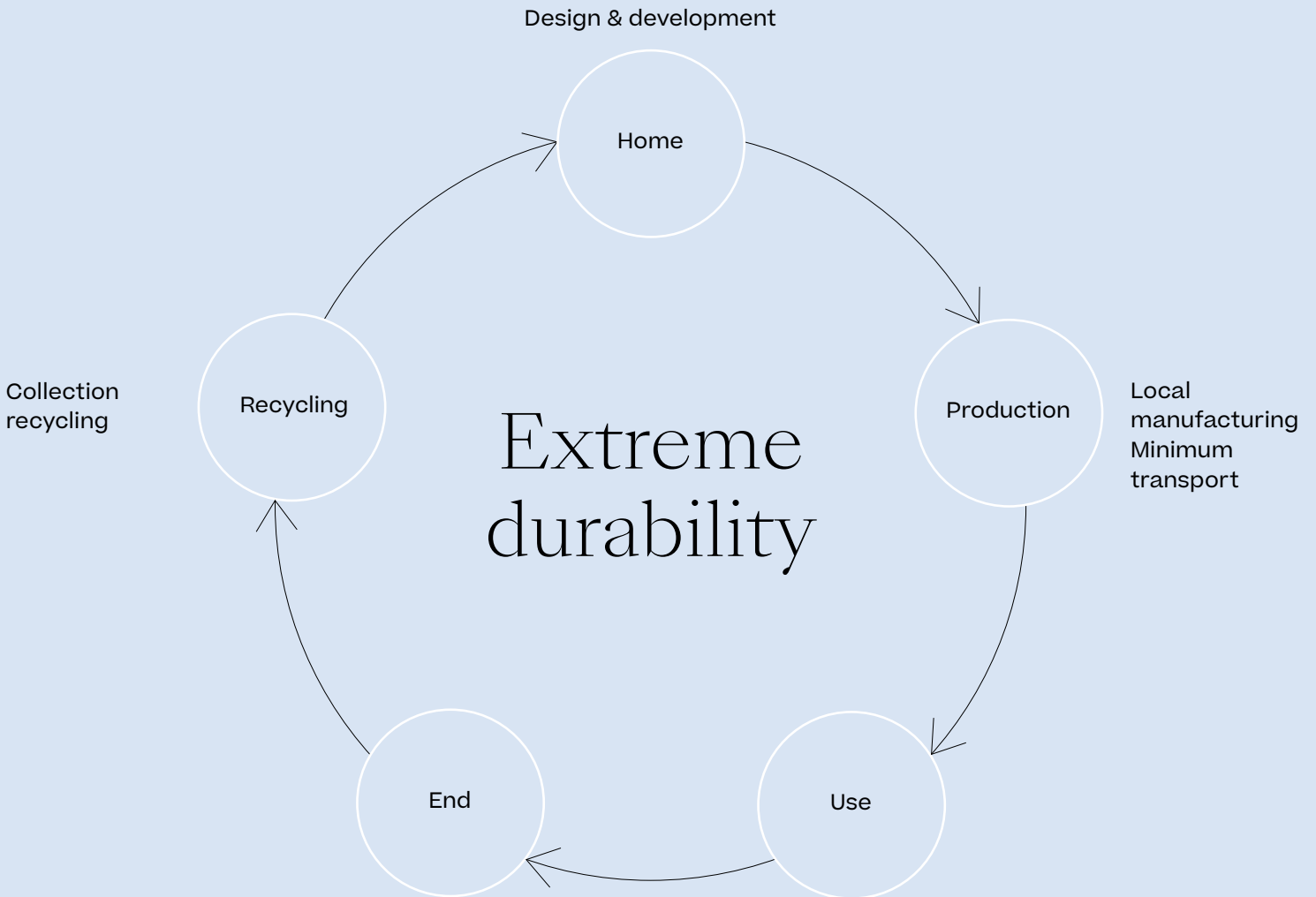

# We would love to hear from you.

## Head office

Kettal Barcelona  
Aragón, 316  
08009 Barcelona, Spain  
T. (34) 93 487 90 90  
F. (34) 93 487 90 66



Download our  
Living catalogue



Download our  
Contract catalogue

## Showrooms

Kettal Barcelona  
Aragón, 316  
08009 Barcelona, Spain  
t. (34) 93 487 90 90  
f. (34) 93 487 90 66

Paris Showroom  
80, Blvd Malesherbes  
75008 Paris, France  
t. (33) 1 43 59 51 40  
boutique.paris@kettal.es

Miami Showroom  
147 Miracle Mile  
Coral Gables,  
Florida 33134, USA  
t. (1) 786 552 90 22  
miami.store@kettal.es

Marbella Showroom  
Crtra. de Cádiz, Km.179  
(entre el Marbella Club  
y el Guadalpin)  
29600 Marbella, Spain  
t. (34) 95 277 89 89  
tienda.marbella@kettal.es

London Showroom  
567 Kings Road,  
London SW6 2 EB  
t. (44) 20 7371 5170  
sales@kettal.co.uk

New York  
The D&D Annex:  
222 East 59th Street  
Suite 222-333  
New York, NY 10022, USA  
t. (1) 917-992-9419  
newyork.showroom@kettal.com

© 2021 KETTAL, S.L. All rights reserved. This catalog as well as its content, consisting of all information, data, texts, photographs, drawing, designs, plans, graphics, trademarks and logos, is offered for your individual and private use. It cannot be reproduced, modified, duplicated, copied, translated, distributed, sold, assigned or commercially exploited, in whole or in part, in any form or by any means, without the express, prior and written authorization of KETTAL, S.L.



